

# BIG WHITE<sup>®</sup> 2025

SLV LIGHTING CATALOGUE



## BEM INFORMADO











Digitalize o código QR, selecione o país e receba sempre os nossos preços atualizados.  
Visite-nos em **slv.com**

Salvo acordo em contrário, todas as entregas e serviços estão sujeitos aos nossos Termos e Condições Gerais, que pode consultar no nosso site em **slv.com**







A SLV tem o direito de adaptar a respetiva lista de preços às alterações nas condições de mercado, no caso de alterações significativas nos custos de aquisição, no imposto de valor acrescentado ou nos preços de aquisição.

\*Observe as condições de garantia em [slv.com](http://slv.com) → Serviço → Transferências → Condições de garantia.

## INTERIOR

	Luminárias para encastrar .....	052
	Luminárias de teto .....	166
	Luminárias suspensas .....	218
	Luminárias de parede e de teto .....	322
	Luminárias de mesa e de pé .....	476
	Sistemas de 48V .....	500
	Sistemas de baixa tensão (12VAC) .....	538
	Calhas monofásicas .....	550
	Calhas trifásicas .....	600
	Perfis e led-strips .....	668

## EXTERIOR

	Balizadores e luminárias móveis .....	696
	Projetores para exterior .....	802
	Luminárias salientes para o teto .....	822
	Luminárias salientes de parede e teto .....	838
	Luminárias para encastrar na parede .....	946
	Luminárias para encastrar no pavimento .....	956



## TECHNICAL LIGHTING



	Interior .....	989
	Industrial .....	1012
	Exterior .....	1026
	Lâmpadas .....	1031

## ACESSÓRIOS

	Lâmpadas .....	1032
	Componentes .....	1044

## NAVEGAÇÃO

Índice de aplicações .....	8
Índice numérico .....	1060
Índice alfabético .....	1075

# NAVEGAÇÃO

## VISÃO GERAL DE CATEGORIAS

Uma visão geral. Encontre a luminária correta com base na sua categoria.

ÍNDICE | LUMINÁRIAS DE ENCASTRAR

0009

ÍNDICE

148000	613	148000	300	152640	665
148002	613	148070	151	152641	665
148010	615	148071	151	152660	665
148514	615	148091	369	152661	665
148520	615	148540	416		
148524	615			<b>153000</b>	
148530	615	<b>149000</b>		153420	659
148534	615	148462	409	153421	659
148551	617	149726	369	153560	661
148561	615	149772	369	153561	661
148564	615			153564	661
148580	615	<b>151000</b>		153860	659
148584	615	151271	366	153861	659
148590	615	151275	366		
148594	615	151232	365	<b>155000</b>	
148600	615	151320	362	155156	213
148604	615	151321	362	155236	499
148630	615	151410	367	155237	200
148634	615	151411	367	155400	497
148640	615	151450	367	155440	495
148644	615	151491	367	155500	206
148660	615	151511	203	155581	206
148664	615	151531	203	155582	207, 201, 497
148670	615	151591	402	155583	207, 201, 497
148674	615	151710	368	155592	207, 201, 497
148680	615	151711	368	155760	495
148684	615	151740	368		
148690	615	151741	368		
148694	615	151781	360	<b>156000</b>	
148700	615	151786	360	156050	208
148710	615	151791	360	156261	208
148714	615	151796	360	156100	207, 201
148720	615	151850	407	156111	207, 201, 497
148724	615	151801	407	156113	207, 201, 497
148730	615	151803	107	156122	207, 201, 497
148734	615	151810	107		
148800	615	151811	107	<b>158000</b>	
148804	615	151830	465	158440	305
148900	226, 227, 279, 281	151861	455	158410	307
148904	226, 227, 279, 281	151840	197, 407, 455		
		158020	309	<b>161000</b>	
<b>148000</b>		151851	309	161271	149
148010	459	151803	309	161281	149
148020	417	151900	160	161461	212
148030	415	151950	160		
148040	415	151960	160	<b>165000</b>	
148060	415	151962	160	165350	321
				165360	319
<b>147000</b>		<b>150000</b>		165400	319
147001	453	150010	455	165410	319
147006	453				
147011	453	150011	455		
147015	453	150020	455	<b>175000</b>	
147021	453	150021	455	175000	607
147026	453	150030	197	175060	607
147060	431	150039	663	175160	607
147061	431	150041	663	175165	607
147070	431	150032	663	175190	607
147071	431	150040	663	175210	607
147080	431	150041	663		
147081	431	150042	663	<b>181000</b>	
147086	436	150050	668	181130	543
147087	436	150051	668	181131	543
147092	435	150030	445	181132	543
147094	435				
147099	457	150090	305	<b>186000</b>	
147100	457	150091	307	186300	543
147101	457	150092	307	186302	543
147109	457	150093	150	186310	543
147151	457	150240	411	186311	543
147159	457	150242	411	186312	543
<b>148000</b>		150243	665	186320	543
148001	211	150241	665	186330	543
148002	210	150600	662	186331	543
148005	211	150601	662	186332	543
148010	387	150610	662	186340	543
148019	391	150611	662	186341	543
148019	391	150760	658	186342	543
148016	391	150761	658	186350	543
148016	396	150762	658	186351	543
148019	389	150761	658	186352	543

1061

## ÍNDICE

Encontre rapidamente a sua luminária no índice numérico ou alfabético.

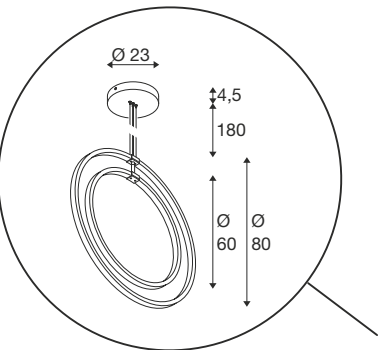

## ATENÇÃO

Todas as medidas são indicadas em **cm**.

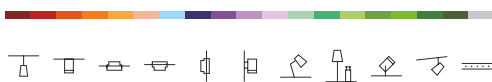

## CATEGORIAS DE PRODUTOS

Saiba para onde vai. Os novos ícones e cores permitem uma navegação rápida e descomplicada das respetivas categorias de produtos.



## RECOMENDAÇÕES

Rápido e fácil. Descubra os acessórios e lâmpadas adequados aos produtos escolhidos por si.

# EXPLICAÇÃO SIMPLES

Na nossa nova secção de conselhos, encontrará todas as informações importantes sobre o tema da luz e dos nossos produtos SLV explicadas de forma rápida e simples.

Desde guias de planeamento a representações do sistema e conhecimentos de iluminação, aprenderá tudo neste BIG WHITE®. Assim, esteja atento às nossas páginas amarelas com conselhos enquanto as folheia.

## CRIE O SEU PERFIL LED

Dê o seu toque pessoal ou ilumine salas inteiras – Possibilidade desde 700 lm por metro até 4000 lm por metro

Adicione cor – Led-strip disponível nas versões branco, CCT (Tunable White) ou RGBW.

Foscas, leitosas ou transparentes subelevada – Escolha entre diferentes para diferentes aplicações e distribuições.

Todos os componentes visíveis são coordenados por cores. As tampas e extremidades são revestidas com cores diferentes.

A superfície de montagem das tiras é revestida a pó para permitir a dissipação de calor.

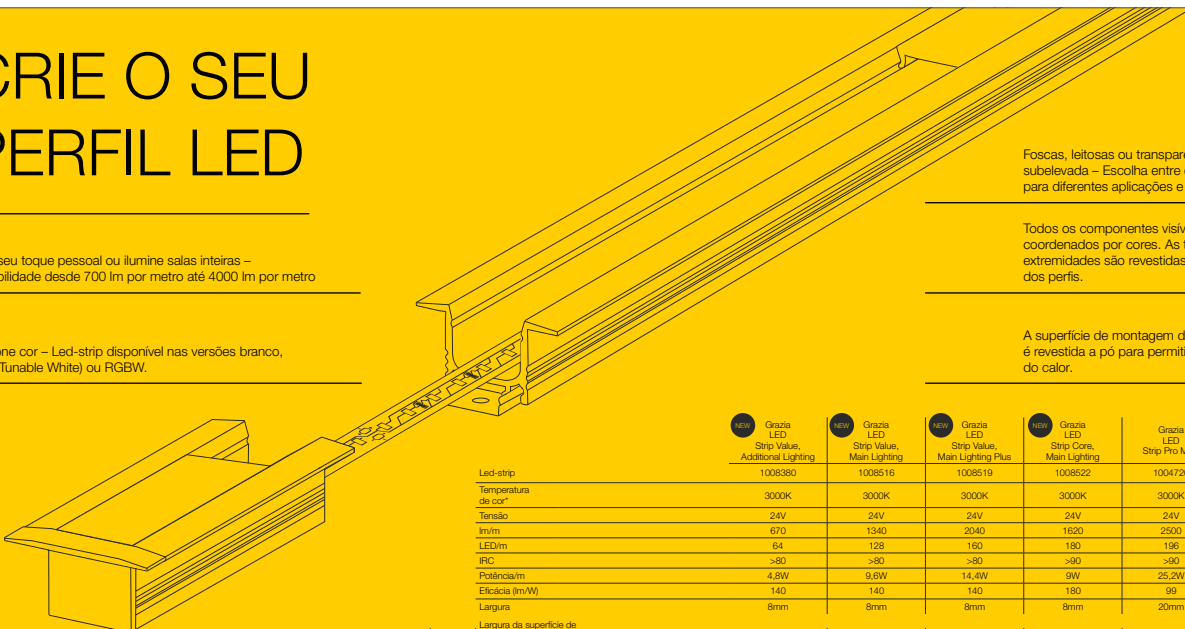

	NEW Grazia LED Strip Value, Additional Lighting	NEW Grazia LED Strip Value, Main Lighting	NEW Grazia LED Strip Value, Main Lighting Plus	NEW Grazia LED Strip Core, Main Lighting	Grazia LED Strip Pro MAX
Led-strip	1008380	1008516	1008519	1008522	1004720
Temperatura de cor*	3000K	3000K	3000K	3000K	3000K
Tensão	24V	24V	24V	24V	24V
lm/m	670	1340	2040	1620	2500
LED/m	64	128	160	180	196
IRC	>80	>80	>80	>80	>80
Potência/m	4,8W	9,6W	14,4W	9W	25,2W
Eficácia (lm/W)	140	140	140	180	99
Largura	8mm	8mm	8mm	8mm	20mm
Largura da superfície de montagem do led-strip					
Perfil	Cor				
GRAZIA 10 Perfil saliente, rebaixado, 2 m	1000462 Preto	✓	✓	✓	-
	1000461 Branco				
GRAZIA 10 Perfil saliente, elevado, 2 m	1000465 Preto	✓	✓	✓	-
	1000464 Branco				
GRAZIA 10 Perfil de encastrar, 2 m	1000459 Preto	✓	✓	✓	-
	1000458 Branco				
GRAZIA 10 Edge, 2 m	1004899 Preto	✓	✓	✓	-
	1004890 Branco				
GRAZIA 20 Perfil saliente, elevado, 3 m	1000525 Preto	✓	✓	✓	✓
	1000524 Branco				
GRAZIA 20 Perfil saliente, rebaixado, 3 m	1000534 Preto	✓	✓	✓	-
	1000533 Branco				
GRAZIA 20 Perfil de encastrar, 3 m	1000498 Preto	✓	✓	✓	✓
	1000497 Branco				
GRAZIA 60 Perfil saliente 1,5 m	1004896 Preto	✓	✓	✓	✓
	1004897 Branco				
GRAZIA 60 Perfil saliente 3 m	1004898 Preto	✓	✓	✓	✓
	1004899 Branco				
GRAZIA 60 Perfil de encastrar, 1,5 m	1004905 Preto	✓	✓	✓	✓
	1004906 Branco				
GRAZIA 60 Perfil de encastrar, 3 m	1004907 Preto	✓	✓	✓	✓
	1004907 Branco				



## TODOS OS PRODUTOS DISPONÍVEIS ONLINE

Em [slv.com](http://slv.com) encontra a gama completa da SLV com todos os dados dos produtos, descrições, disponibilidade e muito mais. Ficheiros de planeamento úteis, dados 3D, configuradores e ferramentas de cálculo como FastCalc by DIAL apoiam-no ao planear a sua iluminação.

# CONHECIMENTOS DE ILUMINAÇÃO DA SLV

---

## LÚMEN

O fluxo luminoso (expresso em lúmenes) descreve a quantidade de luz emitida por uma fonte de luz em todas as direções. É considerada a luminosidade total percebida pelo olho humano. A eficiência de uma luminária também é frequentemente indicada em lúmenes por watt. Quanto maior for o fluxo luminoso emitido (em lúmens) por potência utilizada (em watts), mais eficiente é a fonte de luz.

## IRC

O Índice de Reprodução Cromática é o efeito de uma fonte de luz na impressão de cor que uma pessoa tem de um objeto, em comparação com uma fonte de luz natural (por exemplo, a luz solar). De acordo com a norma EN 12464-1, os espaços interiores onde as pessoas passam muito tempo ou trabalham devem ter um índice de reprodução cromática (IRC) >80.

## TEMPERATURA DE COR

A temperatura de cor de uma fonte de luz é expressa em K (Kelvin). Quanto mais elevada for a temperatura decor, mais fria e ativadora parece a luz (por exemplo: luz do dia = 5500K). Quanto mais baixo for o número Kelvin, mais quente e relaxante é a luz. A temperatura de cor da lâmpada de 2700 K ainda hoje é vista como a luz perfeita para viver. A temperatura de cor de uma luminária pode ser ajustada através da função adicional do interruptor CCT.

## DIM-TO-WARM (DTW)

Com a função Dim-to-Warm é possível regular a temperatura de cor e intensidade das luminárias. A temperatura de cor da luz muda de branco neutro ou frio para branco quente quando a intensidade da luz é reduzida, mas não pode ser controlada além disso.

## TUNEABLE WHITE (TW)

A função Tuneable White permite ajustar suavemente a temperatura da cor das luminárias LED. É assim possível adaptar a luz a diferentes alturas do dia e ambientes.

## RGB RGB+W

Uma luminária com capacidade RGB pode cobrir todo o espectro de cores a partir das cores vermelho, verde e azul, passando o valor branco para segundo plano. Com o complemento de RGB+W, para além de se obter um branco sem coloração também é possível obter tons pastel.

## ÍNDICE DE PROTEÇÃO

Os índices de proteção indicam as medidas de segurança que um dispositivo possui para evitar choques elétricos. Há três classes de proteção, cada uma representada pelos símbolos abaixo.

## IK

O índice de proteção IK é uma classificação de materiais de construção e superfícies que determina a sua resistência a efeitos mecânicos, como impactos, choques ou pressão.

## IP

A abreviatura IP significa Ingress Protection (Proteção de entrada de sólidos/líquidos). O código IP padronizado, por exemplo, usa o primeiro dígito para indicar proteção contra corpos estranhos e contacto, enquanto o segundo descreve a impermeabilidade à água e à humidade.

## ÂNGULO DE MEIA DISPERSÃO

O ângulo de meia dispersão descreve a emissão de luz tendo em conta a construção da luminária, a lâmpada e a distância de um objeto. Quanto mais pequeno o ângulo de meia dispersão, mais estreito o feixe de luz.











































## UGR

UGR (Unified Glare Rating) avalia o encandeamento causado pelas luminárias de modo a aliviar a visão. Quanto mais baixo o UGR, mais agradável é a luz para os olhos. Por conseguinte, recomenda-se uma  $UGR < 19$  para os locais de trabalho.

## SMART LIGHTING

Smart Lighting é o termo utilizado para descrever a gestão automática da luz. Através de DALI, ZIGBEE, CASAMBI e BLUETOOTH, as luminárias inteligentes podem ser controladas através de aplicações e outros elementos de controlo.

LUMINÁRIAS PARA ENCASTRAR NO TETO INTERIOR

 <b>NEW</b>	 <b>NEW</b>	 <b>NEW</b>	 <b>NEW</b>	 <b>NEW</b>	
<b>SCKET</b> KAMI   57	<b>LED</b> UNIVERSAL DOWNLIGHT   59	<b>LED</b> KADUX   62	<b>LED</b> KADUX   63	<b>LED</b> KADUX   65	<b>LED</b> KADUX   65
					
<b>LED</b> KADUX   65	<b>SCKET</b> KADUX   66	<b>SCKET</b> KADUX   66	<b>SCKET</b> KADUX   66	<b>SCKET</b> KADUX   67	<b>SCKET</b> KADUX   67
					
<b>LED</b> NUMINOS® XS   69	<b>LED</b> NUMINOS® S   71	<b>LED</b> NUMINOS® M   73	<b>LED</b> NUMINOS® L   75	<b>LED</b> NUMINOS® XL   77	<b>LED</b> NUMINOS® MOVE XS   79
					
<b>LED</b> NUMINOS® MOVE S   81	<b>LED</b> NUMINOS® MOVE M   83	<b>LED</b> NUMINOS® MOVE L   85	<b>LED</b> NUMINOS® MOVE XL   87	<b>LED</b> NUMINOS® GIMBLE XS   89	<b>LED</b> NUMINOS® GIMBLE S   91
					
<b>LED</b> NUMINOS® GIMBLE M   93	<b>LED</b> NUMINOS® GIMBLE L   95	<b>LED</b> NUMINOS® GIMBLE XL   97	<b>LED</b> NEW TRIA® 68   104	<b>LED</b> NEW TRIA® 68   107	<b>LED</b> NEW TRIA® 75   107
				 <b>NEW</b>	 <b>NEW</b>
<b>LED</b> NEW TRIA® 68   109	<b>LED</b> NEW TRIA® UNIVERSAL 68   111	<b>SCKET</b> NEW TRIA® 68   113	<b>SCKET</b> NEW TRIA® 75 / XL   115	<b>SCKET</b> NEW TRIA®   116	<b>LED</b> NEW TRIA®   117
					
<b>LED</b> NEW TRIA®   118	<b>LED</b> NEW TRIA® 95   124	<b>LED</b> NEW TRIA® 155   127	<b>LED</b> NEW TRIA® 45   130	<b>SCKET</b> NEW TRIA® 150   131	<b>SCKET</b> NEW TRIA® 150   131





**SCKET**  
NEW TRIA® 300 | 131



NEW

**LED**  
MEDO® 30 | 132



NEW

**LED**  
MEDO® 40 | 132



NEW

**LED**  
MEDO® 60 | 133



NEW

**LED**  
MEDO® 90 | 133



NEW

**LED**  
MEDO® 30 | 134



NEW

**LED**  
MEDO® 40 | 134



NEW

**LED**  
MEDO® 60 | 135



NEW

**LED**  
MEDO® 90 | 135



**LED**  
HORN MINI | 136



**SCKET**  
HORN | 137



**SCKET**  
HORN | 137



**SCKET**  
HORN | 137



**SCKET**  
HORN | 138



**SCKET**  
HORN | 138



**SCKET**  
HORN | 138



**SCKET**  
HORN-T | 139



**LED**  
HORN MAGNA | 139



**LED**  
SENDER 12 | 141



**LED**  
SENDER 18 | 141



**LED**  
SENDER 24 | 141



**LED**  
SENDER 12 | 143



**LED**  
SENDER 18 | 143



**LED**  
SENDER 24 | 143



**LED**  
VERLUX | 145



**LED**  
VERLUX | 145



**LED**  
DL 126 | 145



**SCKET**  
PIKA | 146



**SCKET**  
PIKA | 146



**LED**  
OCULUS | 147



**LED**  
OCCULDAS 14 | 148



**LED**  
OCCULDAS 23 | 148



**LED**  
CONTONE® | 149



**LED**  
CONTONE® | 149



**LED**  
KARPO 30 | 150



**SCKET**  
PLASTRA | 151



**SCKET**  
PLASTRA | 151



**LED**  
DEKLED | 152



**SCKET**  
VARU | 152



**SCKET**  
DOLIX OUT | 153



**SCKET**  
DOLIX OUT | 153



**LED**  
KAMUELA ECO | 155

LUMINÁRIAS PARA ENCASTRAR NO TETO INTERIOR



LED  
KINI | 155



LED  
AKALO D83 | 155



LED  
FRAME BASIC  
SET | 156



LED  
FRAME BASIC | 156



LED  
FRAME BASIC | 156



LED  
FRAME CURVE | 157



LED  
FRAME CURVE | 157



LED  
NOTAPO S | 159



LED  
NOTAPO L | 159



LED  
DOWNUNDER  
PUR 80 | 160



LED  
DOWNUNDER  
PUR 150 | 160



LED  
MOBALA | 161



LED  
WORO | 161



LED  
PATTA-I | 162



LED  
PATTA-I | 162



LED  
PATTA-I | 163



LED  
PATTA-I | 163



LED  
PATTA-F | 164



LED  
PATTA-F | 165

LUMINÁRIAS PARA ENCASTRAR NA PAREDE EXTERIOR



LED  
CONCRETO | 949



LED  
CONCRETO | 949



LED  
ADI | 950



LED  
DOWNUNDER  
OUT S | 951



LED  
DOWNUNDER  
OUT M | 951



LED  
DOWNUNDER  
OUT L | 951



LED  
BRICK MESH | 953



LED  
BRICK | 953



LED  
BRICK | 953



SECKET  
BRICK  
DOWNUNDER | 955



LED  
BRICK  
DOWNUNDER | 955

LUMINÁRIAS PARA ENCASTRAR NO PAVIMENTO EXTERIOR

					
LED DASAR® 600   959	LED DASAR® 1200   959	LED DASAR® S   961	LED DASAR® S   961	LED DASAR® M   962	LED DASAR® M   963
					
LED DASAR® L   965	LED DASAR® L   965	LED DASAR® XL   966	LED DASAR® XL   967	LED DASAR® FLAT 80   969	LED DASAR® FLAT 120   969
					
LED DASAR® 255   969	LED DASAR® 920   970	LED DASAR® 920   970	LED DASAR® 270   971	LED DASAR® 270   971	SCKET DASAR® 115   973
					
SCKET DASAR® 115   973	SCKET DASAR® 115   973	SCKET DASAR® EXACT 116   975	SCKET DASAR® EXACT 116   975	SCKET DASAR® 215   976	SCKET DASAR® 215   977
					
SCKET DASAR® 215   977	LED DASAR® 370   977	LED TRAIL-LITE® 60   978	LED POWER TRAIL-LITE®   979	LED POWER TRAIL-LITE®   979	LED SMALL PLOT   981
					
LED SMALL PLOT   981	LED SMALL PLOT   983	LED BIG PLOT   983	LED ROCCI   984	LED ROCCI   984	LED ROCCI 200   985
					
LED ROCCI 200   985	SCKET SOLASTO   987	SCKET SOLASTO   987			

ONE® VERTICAL  
1008003

---





















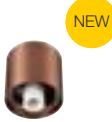











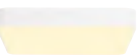
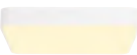











QUIMERA  
1008033

QUIMERA  
1008038

LUMINÁRIAS DE TETO INTERIOR

 NEW	 NEW	 NEW	 NEW		 NEW
<b>SCKET</b> SUN 20   168	<b>SCKET</b> SUN 30   169	<b>SCKET</b> KAMI   170	<b>SCKET</b> KAMI   171	<b>SCKET</b> KAMI   171	<b>SCKET</b> KAMI   171
 NEW	 NEW	 NEW	 NEW	 NEW	 NEW
<b>LED</b> ONE 40   173	<b>LED</b> ONE 60   173	<b>LED</b> ONE 40   175	<b>LED</b> ONE 60   175	<b>SCKET</b> VARYT   177	<b>VARYT</b> VARYT   177
 NEW	 NEW	 NEW			
<b>VARYT</b> VARYT   177	<b>VARYT</b> VARYT   177	<b>VARYT</b> VARYT   177	<b>LED</b> TRILEDO   181	<b>LED</b> TRILEDO   181	<b>LED</b> TRILEDO   181
					
<b>LED</b> NUMINOS° S   182	<b>LED</b> NUMINOS° M   184	<b>LED</b> NUMINOS° L   186	<b>LED</b> NUMINOS° XL   188	<b>LED</b> MEDO°   191	<b>LED</b> MEDO°   191
			 NEW		
<b>SCKET</b> TRILEDO   193	<b>SCKET</b> TRILEDO   193	<b>SCKET</b> TRILEDO   193	<b>LED</b> OCULUS   195	<b>LED</b> OCULUS   196	<b>SCKET</b> ENOLA B   197
					
<b>LED</b> ENOLA C   197	<b>SCKET</b> ASTINA   198	<b>LED</b> ANELA   199	<b>SCKET</b> ASTO TUBE   201	<b>LED</b> OCCULDAS 13   202	<b>LED</b> OCCULDAS 23   202
					
<b>SCKET</b> ALTRA DICE   203	<b>SCKET</b> ALTRA DICE   203	<b>SCKET</b> KARDAMOD   205	<b>SCKET</b> KARDAMOD   205	<b>SCKET</b> FENDA   206	<b>FENDA</b> FENDA   207



FENDA | 207



FENDA | 207



**S**CKET  
TENORA | 208



**S**CKET  
SOPRANA | 209



**S**CKET  
PLASTRA | 210



**LED**  
PLASTRA | 211



**S**CKET  
PLASTRA 105 | 211



**S**CKET  
PLASTRA 104 | 211



**LED**  
FERA 25 | 212



**LED**  
FERA 25 | 212



**LED**  
MARONA | 213



**LED**  
Q-LINE® | 215



**LED**  
Q-LINE® | 215



**LED**  
PANEL 60 | 217



**LED**  
PANEL 60 | 217

LUMINÁRIAS DE TETO EXTERIOR



**S**CKET  
PHOTONI CYL | 825



**S**CKET  
PHOTONI | 825



**LED**  
S-CUBE | 826



**LED**  
ESKINA FRAME | 827



**LED**  
ENOLA OCULUS | 828



**LED**  
ENOLA  
ROUND S | 829



**LED**  
ENOLA  
ROUND M | 829



**LED**  
ENOLA  
ROUND L | 829



**LED**  
ENOLA  
SQUARE S | 831



**LED**  
ENOLA  
SQUARE M | 831



**LED**  
ENOLA  
SQUARE L | 831



**LED**  
BIG THEO | 833



**S**CKET  
BIG THEO | 833



**LED**  
OVALISK | 833



**S**CKET  
MOLAT | 834



**S**CKET  
SITRA | 835



**S**CKET  
ROX | 837



**S**CKET  
ROX | 837























































































LIGHT EYE® 90  
1008173





























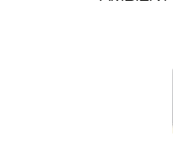











LUMINÁRIAS SUSPENSAS INTERIOR





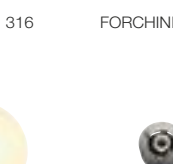

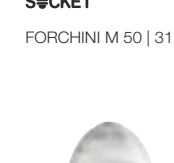
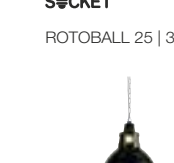























































					
<b>LED</b> QUIMERA   223	<b>SCKET</b> VARYT   225	<b>SCKET</b> VARYT   225	<b>SCKET</b> VARYT   225	<b>SCKET</b> VARYT   225	<b>SCKET</b> VARYT   225
					
<b>SCKET</b> WUD   226	<b>SCKET</b> WUD   227	<b>SCKET</b> WUD   227	<b>SCKET</b> WUD   227	<b>SCKET</b> SUN 20   228	<b>SCKET</b> SUN 20   229
					
<b>SCKET</b> MAGICO 20   231	<b>SCKET</b> MAGICO 38   231	<b>SCKET</b> MAGICO 55   231	<b>LED</b> NUMINOS® S   232	<b>LED</b> NUMINOS® M   234	<b>LED</b> NUMINOS® L   236
					
<b>LED</b> NUMINOS® XL   238	<b>LED</b> MEDO® RING 60   240, 241	<b>LED</b> MEDO® RING 90   241	<b>LED</b> MEDO® PRO 30   242	<b>LED</b> MEDO® PRO 40   243	<b>LED</b> MEDO® PRO 60   244
					
<b>LED</b> MEDO® PRO 90   245	<b>LED</b> MEDO® PRO 30   246	<b>LED</b> MEDO® PRO 40   247	<b>LED</b> MEDO® PRO 60   248	<b>LED</b> MEDO® PRO 90   249	<b>LED</b> MEDO® 30   250
					
<b>LED</b> MEDO® 40   250	<b>LED</b> MEDO® 60   251	<b>LED</b> MEDO® 90   251	<b>LED</b> MEDO®   253	<b>SCKET</b> LALU®   257	<b>LED</b> LALU®   257
					
<b>LED</b> LALU®   258	<b>LED</b> LALU®   259	<b>LED</b> LALU® TETRA 14   260	<b>LED</b> LALU® TETRA 24   260	<b>LED</b> LALU® TETRA 36   260	<b>LED</b> LALU® CONE 15   260

					 <b>NEW</b>
LALU° PLATE 15   260	LALU° PLATE 22   260	LALU° E LYPSE 15   261	LALU° ELYPSE 22   261	LALU° ELYPSE 33   261	ONE° FLAT   265
 <b>NEW</b>	 <b>NEW</b>				
ONE° FLAT   265	ONE° VERTICAL   267	ONE° CUBE   269	ONE° CUBE   269	ONE° 60   271	ONE° 60   271
					
ONE° 60   271	ONE° 80   273	ONE° 80   273	ONE° DOUBLE   274	ONE° DOUBLE   274	ONE° TRIPLE   275
					
ONE° LINEAR 100   277	ONE° LINEAR 140   277	PANTILO ROPE 19   279	PANTILO ROPE 20   279	PANTILO ROPE 27   279	PANTILO OVAL   281
				 <b>NEW</b>	 <b>NEW</b>
PANTILO 20   281	PANTILO 28   281	PANTILO CONVEX 29   283	PANTILO CONVEX 40   283	LIGHT EYE° 90   285	LIGHT EYE° 150   285
					
ASTO TUBE   287	ASTO TUBE   287	ASTO TUBE   287	ASTO TUBE   287	WORKLIGHT PRO 120   289	WORKLIGHT PRO 150   289
					
WORKLIGHT   290	PANEL 60   291	NOYA   292	GLENOS   293	GLENOS   293	Q-LINE°   295



			 <span style="background-color: yellow; border-radius: 50%; padding: 2px;">NEW</span>		
<b>LED</b> Q-LINE®   295	<b>LED</b> Q-LINE®   295	<b>LED</b> OCULUS   296	<b>LED</b> OCULUS   297	<b>SCKET</b> FITU   299	<b>SCKET</b> FENDA   300
					
FENDA   300	FENDA   300	FENDA   301	FENDA   301	FENDA   301	<b>LED</b> HELIA AMBIENT 35   304
					
<b>LED</b> HELIA AMBIENT 35   304	<b>LED</b> HELIA 30   305	<b>LED</b> HELIA 30   305	<b>LED</b> HELIA 40   307	<b>LED</b> HELIA 40   307	<b>SCKET</b> ASTINA   309
					
<b>SCKET</b> ENOLA B   309	<b>SCKET</b> ENOLA   309	<b>LED</b> ANELA   310	<b>SCKET</b> TONGA®   311	<b>SCKET</b> QUADRASS   311	<b>SCKET</b> PARA CONE 20   313
					
<b>SCKET</b> PARA CONE 30   313	<b>SCKET</b> PHELIA 10   315	<b>SCKET</b> PHELIA 20   315	<b>SCKET</b> PHELIA 30   315	<b>SCKET</b> FORCHINI 50   316	<b>SCKET</b> FORCHINI 70   316
					
<b>SCKET</b> FORCHINI M 40   317	<b>SCKET</b> FORCHINI M 50   317	<b>SCKET</b> ROTOBALL 25   319	<b>SCKET</b> ROTOBALL 40   319	<b>SCKET</b> ROTOBALL 50   319	<b>SCKET</b> PARA DOME   320
					
PARA DOME   320	PARA DOME   320	<b>SCKET</b> PARA 380   321			

LUMINÁRIAS DE PAREDE E DE TETO INTERIOR

									
LED QUIMERA   329	LED LYGANT   331	LED LYGANT   331	LED LYGANT   331	SCKET VARYT   333	SCKET VARYT   333	SCKET VARYT   333	SCKET VARYT   333	SCKET VARYT   333	SCKET VARYT   333
									
SCKET VARYT   333	SCKET VARYT   333	SCKET VARYT   333	SCKET SUN   334	SCKET SUN   335	SCKET SUN   335	SCKET SUN   335	LED NUMINOS® S   336	LED NUMINOS® M   338	LED NUMINOS® M   338
									
LED NUMINOS® L   340	LED NUMINOS® XL   342	LED MEDO® PRO 30   344	LED MEDO® PRO 40   345	LED MEDO® PRO 60   346	LED MEDO® PRO 90   347	LED MEDO® PRO 60   346	LED MEDO® PRO 90   347	LED MEDO® PRO 90   347	LED MEDO® PRO 90   347
									
LED MEDO® PRO 30   348	LED MEDO® PRO 40   349	LED MEDO® PRO 60   350	LED MEDO® PRO 90   351	LED MEDO® 30   352	LED MEDO® 30   352	LED MEDO® 30   352	LED MEDO® 40   352	LED MEDO® 40   352	LED MEDO® 40   352
									
LED MEDO® 60   353	LED MEDO® 90   353	LED ONE LINEAR 50   354	LED ONE LINEAR 70   355	LED ONE 40   357	LED ONE 60   357	LED ONE 40   357	LED ONE 60   357	LED ONE 60   357	LED ONE 60   357
									
LED TRUKKO   358	LED TRUKKO   358	LED TRUKKO   359	LED TRUKKO 60   359	LED TRUKKO 90   359	LED TRUKKO 90   359	LED TRUKKO 90   359	LED TRUKKO 90   359	LED TRUKKO 90   359	LED SEDO 14   360
									
LED SEDO 21   360	LED ARLINA 60   361	LED ARLINA 130   361	LED MARYLIN 40   363	LED MARYLIN 60   363	LED MARYLIN 90   363	LED MARYLIN 60   363	LED MARYLIN 90   363	LED MARYLIN 90   363	LED MARYLIN 90   363



**SCKET**

WL 106 | 364



**SCKET**

WL 106 | 364



**SCKET**

MIBO UP/DOWN | 365



**LED**

MAGANDA | 365



**LED**

DORISA 30 | 367



**LED**

DORISA 50 | 367



**LED**

DORISA 60 | 367



**LED**

Q-LINE® | 368



**LED**

L-LINE 60 | 369



**LED**

L-LINE 120 | 369



**SCKET**

PANTILO ROPE | 373



**SCKET**

ASTO TUBE | 375



**SCKET**

ASTO TUBE | 375



**LED**

MANA BASE | 377



MANA BASE | 378



MANA 40 | 378



MANA 60 | 378



MANA 40 | 379

NEW



NEW

MANA 40 | 379



NEW

MANA 40 | 379



NEW

MANA 60 | 379



NEW

MANA 60 | 379



NEW

MANA 60 | 379



MANA | 381



MANA | 381



**LED**

MANA | 383



MANA | 383



**LED**

OCULUS | 385



**LED**

OCULUS | 385



**LED**

OCULUS | 385

NEW



**SCKET**

PLASTRA | 386



**SCKET**

PLASTRA | 386



**SCKET**

PLASTRA | 387



**SCKET**

PLASTRA | 387



**SCKET**

PLASTRA | 389



**LED**

PLASTRA | 389



**LED**

PLASTRA | 389



**SCKET**

PLASTRA | 390



**SCKET**

PLASTRA 101 | 391



**SCKET**

PLASTRA | 391



**SCKET**

PLASTRA 104 | 391



**LED**

LOGS IN | 392

LUMINÁRIAS DE PAREDE E DE TETO INTERIOR



LED  
LOGS IN | 392



LED  
LOGS IN L | 393



LED  
LOGS IN L | 393



LED  
QUAD FRAME 14 | 395



LED  
QUAD FRAME 19 | 395

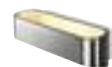

LED  
ASSO 300 | 396



LED  
ASSO 300 | 397



SCKET  
OSSA 180 | 397



SCKET  
ASSO 300 | 397



LED  
CARISO | 398



LED  
CARISO | 398



LED  
CHROMBO | 399



LED  
DIRETO 60 | 401



LED  
DIRETO 90 | 401



SCKET  
DENA 30 | 402



SCKET  
BASKET | 402



SCKET  
QUADRASS | 403



LED  
QUADRASS SPOT | 403



FITU | 404



FITU CUBE | 404



SCKET  
THEO UP/DOWN | 405



SCKET  
SOLID CUBE | 405



SCKET  
ENOLA B | 407



SCKET  
ENOLA B | 407



SCKET  
ASTINA UP/DOWN | 407



SCKET  
FENDA | 408



FENDA | 408



LED  
KENKUA SPOT | 409



LED  
COUPA FLEX | 409



LED  
KARPO MAGN | 410



LED  
KARPO MAGN | 410



LED  
KARPO 30 | 411



LED  
KARPO | 411



LED  
SOMNILA SPOT | 412



LED  
SOMNILA SPOT | 413



LED  
SOMNILA FLEX | 413



LED  
SOMNILA FLEX | 413



SCKET  
DIO FLEX PLATE | 415



LED  
DIO FLEX PLATE | 415























PHELIA | 416



LED  
MERADO FLOOD | 416



SCKET  
DISPLAY ADL 50 | 417

 <b>LED</b> DECONA 30   418	 <b>LED</b> DECONA 42   419	 <b>SCKET</b> PURI 2.0   421	 <b>SCKET</b> PURI 2.0   421	 <b>SCKET</b> PURI 2.0   421	 <b>SCKET</b> PURI 2.0   420
 <b>SCKET</b> PURI 2.0   421	 <b>SCKET</b> PURI 2.0   421	 <b>SCKET</b> PURI 2.0   421	 <b>SCKET</b> PURI 2.0   423	 <b>SCKET</b> PURI 2.0   423	 <b>SCKET</b> PURI 2.0   423
 <b>SCKET</b> PURI 2.0   422	 <b>SCKET</b> PURI 2.0   423	 <b>SCKET</b> PURI 2.0   423	 <b>SCKET</b> PURI 2.0   423	 <b>SCKET</b> PURI 2.0   425	 <b>SCKET</b> PURI 2.0   425
 <b>SCKET</b> PURI 2.0   425	 <b>SCKET</b> PURI 2.0   424	 <b>SCKET</b> PURI 2.0   425	 <b>SCKET</b> PURI 2.0   425	 <b>SCKET</b> PURI 2.0   425	 <b>SCKET</b> PURI 2.0   427
 <b>SCKET</b> PURI 2.0   427	 <b>SCKET</b> PURI 2.0   427	 <b>SCKET</b> PURI 2.0   426	 <b>SCKET</b> PURI 2.0   427	 <b>SCKET</b> PURI 2.0   427	 <b>SCKET</b> PURI 2.0   427
 <b>SCKET</b> PURI 2.0   429	 <b>SCKET</b> PURI 2.0   429	 <b>SCKET</b> PURI 2.0   429	 <b>SCKET</b> PURI   431	 <b>SCKET</b> PURI   431	 <b>SCKET</b> PURI   431
 <b>SCKET</b> PURI   431	 <b>SCKET</b> AVO   433	 <b>SCKET</b> AVO   433	 <b>SCKET</b> AVO   433	 <b>SCKET</b> AVO   433	 <b>SCKET</b> ASTO   435

LUMINÁRIAS DE PAREDE E DE TETO INTERIOR



**SCKET**  
ASTO | 435



**SCKET**  
ASTO | 435



**SCKET**  
ASTO | 435



**SCKET**  
PANTILO  
ROPE 19 | 437



**SCKET**  
PANTILO  
ROPE 27 | 437



**LED**  
CYFT WAVE | 439



**LED**  
CYFT | 439



NEW

**SCKET**  
KAMI | 441



**SCKET**  
ASTO TUBE | 443



**SCKET**  
ASTO TUBE | 443



**SCKET**  
ASTO TUBE | 443



**SCKET**  
ASTO TUBE | 443



**LED**  
OCULUS | 445



**LED**  
KARPO 30 | 445



NEW

**LED**  
NOBLO® | 447



NEW

**LED**  
NOBLO® | 447



NEW

**LED**  
NOBLO® | 447



NEW

**LED**  
NOBLO® | 449



NEW

**LED**  
NOBLO® | 449



NEW

**LED**  
NOBLO® | 449



**LED**  
KALU | 451



**LED**  
KALU | 451



**LED**  
KALU | 451



**LED**  
KALU | 451



**SCKET**  
KALU | 453



**SCKET**  
KALU | 453



**SCKET**  
KALU | 453



**SCKET**  
KALU | 453



**SCKET**  
ENOLA B | 455



**SCKET**  
ENOLA B | 455



**SCKET**  
ENOLA B | 455



**SCKET**  
ALTRA DICE | 456



**LED**  
SPOT 79 | 457



**LED**  
INDA 12 | 457



**LED**  
SENSER 12 | 459



**LED**  
SENSER 18 | 459



**LED**  
SENSER 24 | 459



**LED**  
SENSER 12 | 461



**LED**  
SENSER 18 | 461



**LED**  
SENSER 24 | 461



**LED**  
SIMA | 462



**LED**  
SIMA | 462





SIMA | 463



SIMA | 463



LIPSY® 30 | 465



LIPSY® 40 | 465



LIPSY® 50 | 465



LIPSY® 30 | 467



LIPSY® 40 | 467



LIPSY® 50 | 467



LIPSY® 40 | 468



LIPSY® 50 | 468



MELAN | 469



BATTEN 60 | 471



BATTEN 120 | 471



LONG GRILL | 473



SIGHT 60 | 475



SIGHT 115 | 475









































VARYT  
1008110+1007859





GRID CUBE  
1008477

LUMINÁRIAS DE PAREDE E DE TETO EXTERIOR

		 NEW			
LED R-CUBE   843	LED S-CUBE   843	SCKET PHOTONI CYL   845	SCKET PHOTONI   845	LED LID I   846	LED LID I   846
		 NEW	 NEW	 NEW	 NEW
LED LID II   847	LED LID II   847	LED Q-RING   849	LED Q-RING   849	LED D-RING S   851	LED D-RING M   851
					
LED I-RING   852	LED OVAL 14   853	LED OVAL 18   853	LED CONCRETO M   855	LED CONCRETO L   855	LED VANO WING   857
					
LED VANO WING   857	LED MANA BASE   858	LED RUSTY® MANA   858	LED RUSTY® MANA   858	LED MANA OUT   859	LED MANA OUT   859
					
SCKET THEO UP/DOWN   861	LED BIG THEO BEAM UP/ FLOOD DOWN   861	SCKET BIG THEO UP/ DOWN   861	SCKET THEO   862	LED BIG THEO FLOOD UP/ DOWN   862	SCKET BIG THEO   863
					
LED BIG THEO   863	LED ENOLA OCULUS   865	LED ENOLA OCULUS   865	LED ENOLA ROUND S   867	LED ENOLA ROUND M   867	LED ENOLA ROUND L   867
					
LED ENOLA ROUND S UP/DOWN   869	LED ENOLA ROUND M UP/DOWN   869	LED ENOLA ROUND L UP/DOWN   869	LED ENOLA SQUARE S   871	LED ENOLA SQUARE M   871	LED ENOLA SQUARE L   871



LED  
ENOLA SQUARE S  
UP/DOWN | 872



LED  
ENOLA SQUARE M  
UP/DOWN | 872



LED  
ENOLA SQUARE L  
UP/DOWN | 872



LED  
SITRA S | 877



LED  
SITRA S | 877



LED  
SITRA M | 879



LED  
SITRA L | 879



SOCKET  
SITRA CUBE | 879



SOCKET  
GRAFIT | 880



SOCKET  
GRAFIT | 880



SOCKET  
GRAFIT | 881



SOCKET  
GRAFIT | 881



LED  
QUADRULO | 882



SOCKET  
QUADRULO  
SENSOR | 883



SOCKET  
QUADRULO | 883



SOCKET  
MERIDIAN | 884



SOCKET  
MERIDIAN BOX | 884



SOCKET  
MERIDIAN BOX  
SENSOR | 885



SOCKET  
MERIDIAN BOX | 885



LED  
ESKINA FRAME | 887



LED  
ESKINA FRAME | 887



LED  
ESKINA FRAME | 887



LED  
BOOKAT | 889



LED  
BIG QUAD | 890



LED  
BIG QUAD  
UP/DOWN | 891



LED  
QUAD | 892



LED  
QUAD  
UP/DOWN 15 | 893



LED  
RUSTY®  
UP/DOWN | 894



LED  
RUSTY®  
UP/DOWN | 894



LED  
OVALISK  
SENSOR | 895



LED  
OVALISK | 895



LED  
PEMA® | 896

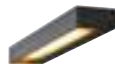

LED  
PEMA® | 897



LED  
PEMA® | 897



SOCKET  
PEMA® | 897



LED  
FLATT | 898



LED  
FLATT SENSOR | 898



SOCKET  
ASTINA | 899



SOCKET  
ASTINA STEEL | 899



LED  
MODELA | 901

NEW



LED  
ANGOLUX  
SENSOR | 902



LED  
ANGOLUX | 902

LUMINÁRIAS DE PAREDE E DE TETO EXTERIOR



LED  
VILUA S | 903



LED  
VILUA L | 903



LED  
VILUA | 903



SCKET  
MYRA UP/DOWN | 904



LED  
SITRA UP/DOWN | 905



SCKET  
SITRA UP/DOWN | 905



SCKET  
ROX UP/DOWN | 907



LED  
DELWA | 907



NEW

SCKET  
T-TUBE | 840



NEW

SCKET  
T-TUBE | 840



NEW

SCKET  
T-TUBE | 841



NEW

SCKET  
T-TUBE | 841



SCKET  
WALLYX | 910



LED  
DOWNUNDER  
OUT | 911



LED  
DOWNUNDER  
OUT | 911



NEW

LED  
ABRIDOR | 913



LED  
ABRIDOR | 915



LED  
ABRIDOR  
SENSOR | 915



NEW

LED  
ORDI II SENSOR | 916



NEW

LED  
ORDI II | 916



LED  
ORDI SENSOR | 917



LED  
ORDI | 917



SCKET  
BOX-L | 919



LED  
BOX-L | 919



SCKET  
BOX UP/DOWN | 919



LED  
LOGS | 921



LED  
OUT-BEAM UP/  
FLOOD DOWN | 921



LED  
L-LINE OUT | 921



SCKET  
PHOTONIA | 923



SCKET  
MOLAT | 923



SCKET  
GLOO PURE | 923



SCKET  
F-POL | 924



SCKET  
SQUARE | 925



SCKET  
KERAS ELT | 925



SCKET  
SITRA | 925



LED  
IPERI | 926



SCKET  
QUADRASYL | 927



SCKET  
SQUARE TURN | 927



LED  
TODAY PRO | 929



LED  
ESKINA D | 929



SCKET  
MYRA DISPLAY | 929



LED  
LED SPOT | 931



**SCKET**

NAUTILUS | 931



**SCKET**

MYRA | 931



**LED**

RASTERLYS | 933



**SCKET**

RASTERLYS | 935



**LED**

R-CUBE | 935



**LED**

S-CUBE | 935



**LED**

ESKINA SPOT  
SENSOR | 937



**LED**

ESKINA SPOT | 937



**SCKET**

SITRA 360 | 938



**SCKET**

THEO BRACKET | 938



**LED**

HELIA | 939



**LED**

HELIA | 939



**SCKET**

MYRA | 941



**LED**

OUT-BEAM  
FRAME | 941

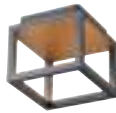

**LED**

QUADRULO | 941



**LED**

AINOS | 942



**LED**

AINOS | 943

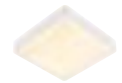

**LED**

AINOS | 943



**LED**

AINOS | 943



**LED**

RUBA | 944



**LED**

TERANG 200 | 944



**SCKET**

BULAN | 945



**SCKET**

BULAN GRID | 945

















A modern, cylindrical table lamp with a black top and bottom cap and a central body composed of vertical, glowing light tubes. The lamp is placed on a dark surface next to a glass vase containing pink flowers. The background features a wall with a large, green, tropical leaf pattern.

QUIMERA  
1008038





LUMINÁRIAS DE MESA E DE PÉ INTERIOR

 <p><b>SCKET</b> VARYT   478</p>	<p>NEW</p>  <p>VARYT   479</p>	<p>NEW</p>  <p>VARYT   479</p>	<p>NEW</p>  <p>VARYT   479</p>	<p>NEW</p>  <p>VARYT   479</p>	<p>NEW</p>  <p><b>LED</b> QUIMERA   481</p>
 <p><b>LED</b> ONE STRAIGHT   483</p>	 <p><b>LED</b> ONE BOW   483</p>	 <p><b>LED</b> VINOLINA ONE   485</p>	 <p><b>LED</b> VINOLINA   485</p>	 <p><b>LED</b> VINOLINA TWO   487</p>	 <p><b>LED</b> TAHA   489</p>
 <p><b>SCKET</b> TINY SUN   491</p>	 <p><b>SCKET</b> LITTLE SUN   491</p>	 <p><b>LED</b> WORKLIGHT PRO   492</p>	 <p><b>LED</b> WORKLIGHT PRO   492</p>	 <p><b>LED</b> WORKLIGHT   493</p>	 <p><b>LED</b> WORKLIGHT   493</p>
 <p><b>SCKET</b> FENDA   495</p>	 <p><b>SCKET</b> FENDA   495</p>	 <p><b>SCKET</b> FENDA   495</p>	 <p><b>SCKET</b> FENDA   497</p>	 <p>FENDA   497</p>	 <p>FENDA   497</p>
 <p>FENDA   497</p>	 <p>FENDA   497</p>	 <p><b>LED</b> KARPO   498</p>	 <p><b>LED</b> KARPO   498</p>	 <p><b>SCKET</b> PHELIA   499</p>	



T-TUBE 70  
1008017



LUMINÁRIAS MÓVEIS E LUMINÁRIAS DE PÉ EXTERIOR

 NEW LED SUN GRID   701	 NEW LED GRID CUBE   701	 LED VINOLINA ONE   703	 LED VINOLINA   703	 LED VINOLINA TWO   705	 LED TAHA   707
 SCKET S-TUBE 32/75   709	 SCKET PHOTONI CYL   711	 SCKET PHOTONI 45/75   713	 LED S-CUBE 35/75   714	 LED R-CUBE 35/75   715	 LED ADEGAN   717
 LED ADEGAN   717	 LED I-RING   718	 LED LID 145/75   719	 LED M-POL S   720	 LED M-POL S   721	 LED M-POL S   722
 LED M-POL S   723	 LED M-POL S   724	 LED M-POL M   725	 LED M-POL M   726	 LED M-POL M   727	 M-POL 30/60/90   728, 729
 SCKET CONCRETO   733	 SCKET CONCRETO   733	 LED RASTERLYS   735	 LED ESKINA FRAME 45/75   737	 LED ESKINA FRAME 75   737	 LED ESKINA FRAME 125/175   738
 LED ESKINA 30/80   739	 SCKET T-TUBE 70   740, 741	 SCKET T-TUBE 70   740, 741	 LED LOGS 40/70   743	 SCKET GRAFIT 30/60/90   745	 SCKET GRAFIT 30/60/90   747
 LED QUADRULO   749	 LED RUSTY® SLOT 50/80   750	 SCKET RUSTY® SLOT 50/80   751	 SCKET RUSTY® PATHLIGHT   752	 LED RUSTY® PATHLIGHT 40/70   753	 LED RUSTY® 40/70   755



**SCKET**  
RUSTY® 40/70 | 697



**SCKET**  
RUSTY® CONE 24 | 757



**SCKET**  
RUSTY® CONE 40/70 | 757



**SCKET**  
RUSTY® 40/70 | 758



**SCKET**  
ARROCK GRANITE 40/70 | 759



**SCKET**  
ARROCK ARC | 760



**LED**  
ARROCK STONE 50/75 | 761



**SCKET**  
ARROCK SLOT | 761



**LED**  
L-LINE OUT 30 | 762



**LED**  
L-LINE OUT 60 | 763



**LED**  
L-LINE OUT 50/80 | 763



**SCKET**  
THEO PATHLIGHT | 764



**LED**  
OVALISK 75/100 | 765



**SCKET**  
GLOO PURE 27/44/70 | 767



**SCKET**  
ROTOBALL 25/40/50 | 769



**SCKET**  
PHOTONIA | 771



**SCKET**  
OTOS GLAS | 771



**SCKET**  
CUBIX | 772



**SCKET**  
CONE | 772



**SCKET**  
MOLAT | 773



**SCKET**  
MOLAT | 773



**SCKET**  
LISENNE 40/70 | 774



**SCKET**  
ADEGAN | 775



**SCKET**  
ALPA MUSHROOM 45/75 | 777



**SCKET**  
ALPA CONE 100 | 777



**LED**  
APONI 90/120 | 778



**LED**  
TRUST 30/60 | 779



**SCKET**  
BIG NAILS 50/80 | 780



**SCKET**  
ROX ACRYL 30/60/90 | 781



**SCKET**  
VAP SLIM 30/60/90 | 783



**SCKET**  
C-POL | 784



**SCKET**  
F-POL | 784



**SCKET**  
SQUARE POLE 30/60/90 | 785



**LED**  
SLOTS 45/65 | 787



**LED**  
H-POL 30/60 | 788



**LED**  
H-POL TWIN 60 | 789

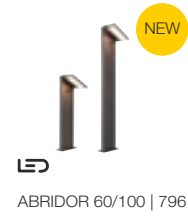



SYNA GARDEN  
1007147



PROJETOR EXTERIOR

 <p><b>LED</b> SYNA   804</p>	<p>NEW</p>  <p><b>SCKET</b> SYNA   805</p>	 <p><b>LED</b> SYNA PLANT   807</p>	 <p><b>LED</b> SYNA GARDEN   807</p>	 <p><b>LED</b> SYNA   807</p>	 <p><b>LED</b> GALEN 60   808</p>
 <p><b>LED</b> GALEN 120   808</p>	 <p><b>LED</b> FLAC BEAM®   809</p>	 <p><b>SCKET</b> SAMRINA   809</p>	 <p><b>SCKET</b> NAUTILUS 10   810</p>	 <p><b>SCKET</b> BIG NAUTILUS   810</p>	 <p><b>SCKET</b> NAUTILUS 10   811</p>
 <p><b>LED</b> NAUTILUS 10   812</p>	 <p><b>SCKET</b> NAUTILUS   813</p>	 <p><b>SCKET</b> NAUTILUS 10 SPOT   813</p>	 <p><b>LED</b> NAUTILUS 10 SPOT LED   813</p>	 <p><b>LED</b> DASAR® PROJECTOR   815</p>	 <p><b>LED</b> DASAR® 920   815</p>
<p>NEW</p>  <p><b>LED</b> HELIA SLIM   816</p>	<p>NEW</p>  <p><b>LED</b> HELIA SLIM   816</p>	 <p><b>LED</b> HELIA SPOT S   817</p>	 <p><b>LED</b> HELIA SPOT L   817</p>	 <p><b>SCKET</b> THEO BRACKET   819</p>	 <p><b>LED</b> LED SPIKE   819</p>
 <p><b>SCKET</b> SITRA 360 SPIKE   821</p>	 <p><b>SCKET</b> SITRA 360 SPIKE   821</p>				

IN-LINE 44  
1006621

NUMINOS® XS  
1006762



NUMINOS® XS  
1006654

















SISTEMAS DE 48 V INTERIOR

					
LED NUMINOS® XS   514	LED NUMINOS® S   516	LED NUMINOS® XS   518	LED NUMINOS® S   520	LED IN-LINE 22   523	LED IN-LINE 22   523
				 <span style="background-color: yellow; border-radius: 50%; padding: 2px;">NEW</span>	 <span style="background-color: yellow; border-radius: 50%; padding: 2px;">NEW</span>
LED IN-LINE 44   525	LED IN-LINE 44   525	LED IN-LINE 24   527	LED IN-LINE 46   527	LED GRIP! S   529	LED GRIP! S   529
 <span style="background-color: yellow; border-radius: 50%; padding: 2px;">NEW</span>	 <span style="background-color: yellow; border-radius: 50%; padding: 2px;">NEW</span>	 <span style="background-color: yellow; border-radius: 50%; padding: 2px;">NEW</span>	 <span style="background-color: yellow; border-radius: 50%; padding: 2px;">NEW</span>	 <span style="background-color: yellow; border-radius: 50%; padding: 2px;">NEW</span>	
LED GRIP! S   529	LED GRIP! S   531	LED GRIP! S   531	LED GRIP! S   531	LED LALU® PD   533	LALU® TETRA 14   534
					
LALU® TETRA 24   534	LALU® ELYPSE 15   535	LALU® PLATE 15   535	LALU® CONE 15   535	LALU® ELYPSE 22   535	LALU® PLATE 22   535









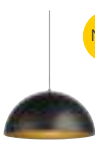

SISTEMAS DE BAIXA TENSÃO INTERIOR

					
SOCKET ASMARA   544	SOCKET TELESKOP   544	SOCKET COSMIC   545	SOCKET SYROS   547	SOCKET SALUNA   547	LED DURNO   547
					
LED PLYTTA   548	LED NOBLO SPOT   549	LED COMET LED   549	SOCKET COMET   549		











































NOBLO® SPOT  
1007352

SISTEMAS MONOFÁSICOS INTERIOR

	<p>NEW</p>		<p>NEW</p>		<p>NEW</p>		<p>NEW</p>		<p>NEW</p>		<p>NEW</p>
<p><b>LED</b> QUIMERA   559</p>		<p><b>SCKET</b> FORCHINI M 40 TRACK   561</p>		<p><b>SCKET</b> PURI 2.0   563</p>		<p><b>SCKET</b> PURI 2.0   563</p>		<p><b>SCKET</b> PURI 2.0   563</p>		<p><b>SCKET</b> PURI 2.0   565</p>	
	<p>NEW</p>		<p>NEW</p>		<p>NEW</p>		<p>NEW</p>		<p>NEW</p>		<p>NEW</p>
<p><b>SCKET</b> PURI 2.0   565</p>		<p><b>SCKET</b> PURI 2.0   565</p>		<p><b>SCKET</b> PURI 2.0   566</p>		<p><b>SCKET</b> PURI 2.0   567</p>		<p><b>PURI 2.0</b>   567</p>		<p><b>PURI 2.0</b>   567</p>	



 NEW PURI 2.0   567	 NEW LED GRIP! S   569	 NEW LED GRIP! S   569	 NEW LED GRIP! S   569	 NEW LED GRIP! M   571	 NEW LED GRIP! M   571
 NEW LED GRIP! M   571	 NEW SCKET GRIP! L   573	 NEW SCKET GRIP! L   573	 NEW SCKET LIGHT EYE® 90   576	 NEW SCKET LIGHT EYE® 150   577	 NEW SCKET LIGHT EYE® 90   579
 NEW SCKET LIGHT EYE® 150   579	 SCKET KALU TRACK   581	 LED KALU TRACK   581	 LED NOBLO SPOT   582	 LED NOBLO SPOT   582	 LED NOBLO SPOT   583
 LED NOBLO SPOT   583	 SCKET ASTO TUBE   585	 SCKET PANTILO ROPE 19   585	 SCKET PARA CONE GL   587	 SCKET PARA CONE 14   587	 SCKET PARA CONE 14   587
 LED HELIA 50 TRACK   589	 LED PANEL TRACK   589	 LED PANEL TRACK   589	 SCKET PURI TRACK   591	 SCKET PURI TRACK   591	 SCKET TONGA®   592
 SCKET PURIA TRACK   593	 SCKET AVO TRACK   593	 LED ENOLA C TRACK   594	 LED ENOLA C TRACK   594	 SCKET ENOLA B TRACK   595	 SCKET ENOLA B   595
 LED BIMA   597	 SCKET BIMA   597	 SCKET EURO SPOT TRACK   598	 SCKET ALTRA DICE TRACK   599		

























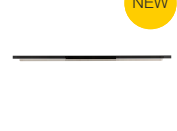









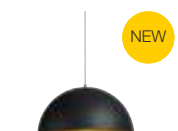



TRACKSPOT V  
1007655

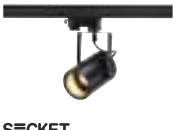

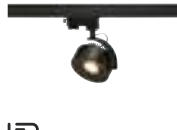
SISTEMAS TRIFÁSICOS INTERIOR

- |                                                                                    |                                                                                     |                                                                                     |                                                                                     |                                                                                      |                                                                                       |
|------------------------------------------------------------------------------------|-------------------------------------------------------------------------------------|-------------------------------------------------------------------------------------|-------------------------------------------------------------------------------------|--------------------------------------------------------------------------------------|---------------------------------------------------------------------------------------|
|  |  |  |  |  |  |
| <b>SCKET</b>                                                                       | <b>SCKET</b>                                                                        | <b>SCKET</b>                                                                        | <b>SCKET</b>                                                                        | <b>SCKET</b>                                                                         | <b>SCKET</b>                                                                          |
| PURI 2.0   619                                                                     | PURI 2.0   619                                                                      | PURI 2.0   619                                                                      | PURI 2.0   621                                                                      | PURI 2.0   621                                                                       | PURI 2.0   621                                                                        |
|  |  |  |  |  |  |
| <b>SCKET</b>                                                                       | <b>SCKET</b>                                                                        |                                                                                     |                                                                                     |                                                                                      | <b>LED</b>                                                                            |
| PURI 2.0   622                                                                     | PURI 2.0   623                                                                      | PURI 2.0   623                                                                      | PURI 2.0   623                                                                      | PURI 2.0   623                                                                       | GRIP! M   624                                                                         |

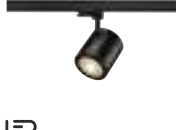

 NEW	 NEW	 NEW	 NEW		
LED GRIP! M   624	LED GRIP! M   625	LED GRIP! M   625	SCKET GRIP! L   627	LED NUMINOS® S   628	LED NUMINOS® M   630
					
LED NUMINOS® L   632	LED NUMINOS® XL   634	LED NUMINOS® ZOOM M   636	LED ONE 40 TRACK   643	LED NOBLO SPOT   644	LED NOBLO SPOT   644
		 NEW	 NEW		
LED NOBLO SPOT   645	LED NOBLO SPOT   645	LED SIGHT EASY   647	LED SIGHT EASY   647	LED SIGHT TRACK   648	LED SIGHT TRACK   648
					
LED SIGHT MOVE   649	LED SIGHT MOVE   649	SCKET PARA CONE 14   651	SCKET PARA CONE 14   651	SCKET PARA CONE GL   653	SCKET PARA CONE GL   653
 NEW	 NEW	 NEW	 NEW		
SCKET FORCHINI M 40 TRACK   655	SCKET LIGHT EYE® 90   656	SCKET LIGHT EYE® 150   657	SCKET LIGHT EYE® 150   657	SCKET ALTRA DICE TRACK   658	LED EURO CUBE   658
					
SCKET EURO SPOT TRACK   659	SCKET EURO SPOT TRACK   659	SCKET PURI TRACK   661	SCKET PURI TRACK   661	LED KALU TRACK   662	SCKET KALU TRACK   662
					
SCKET BIMA   663	SCKET BIMA   663	LED HELIA 50 TRACK   665	LED ENOLA C TRACK   665	SCKET AVO TRACK   665	

GRAZIA IP  
FLEXSTRIP  
1004737



PERFIS



GRAZIA 10 PERFIL SALIENTE | 669



GRAZIA 10 PERFIL DE ENCASTRAR | 669



GRAZIA 10 EDGE | 672

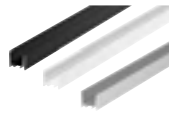

GRAZIA 20 PERFIL SALIENTE | 675



GRAZIA 20 PERFIL DE ENCASTRAR | 675

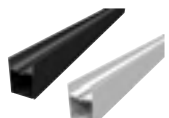

GRAZIA 60 PERFIL SALIENTE | 679

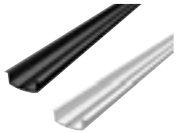

GRAZIA 60 PERFIL DE ENCASTRAR | 679



GRAZIA 10 ACESSÓRIOS | 671



GRAZIA 10 EDGE ACESSÓRIOS | 673



GRAZIA 20 ACESSÓRIOS | 676-677



GRAZIA 60 ACESSÓRIOS | 680-681

FITAS LED



FITA LED GRAZIA VALUE ADDITIONAL LIGHTING E ACESSÓRIOS | 684



FITA LED GRAZIA VALUE MAIN LIGHTING E ACESSÓRIOS | 685



FITA LED GRAZIA VALUE MAIN LIGHTING + E ACESSÓRIOS | 686



FITA LED GRAZIA CORE MAIN LIGHTING E ACESSÓRIOS | 687



GRAZIA PRO MAX FLEXSTRIP E ACESSÓRIOS | 688



GRAZIA PRO MAX FLEXSTRIP E ACESSÓRIOS | 689



GRAZIA PRO FLEXSTRIP TUNABLE WHITE E ACESSÓRIOS | 690



GRAZIA PRO FLEXSTRIP RGBW E ACESSÓRIOS | 691



GRAZIA IP FLEXSTRIP | 692



GRAZIA IP FLEXSTRIP TUNABLE WHITE E ACESSÓRIOS | 693



GRAZIA IP FLEXSTRIP RGBW E ACESSÓRIOS | 693





















































































HIGHBAY C 400  
1008526 + 1008530







SLVtec

					
					
PANEL C 600   990	PANEL C DALI 600   991	PANEL C 625   993	PANEL C DALI 625   993	PANEL C 1200   995	PANEL C DALI 1200   995
					
					
PANEL V 600   996	PANEL V 600   997	PANEL V DALI 600   997	PANEL V 625   998	PANEL V 625   999	PANEL V DALI 625   999
					
					
SURFACE V 390   1001	SURFACE V 390   1001	TRACKSPOT V   1002	TRACKSPOT V   1003	DOWNLIGHT C   1005	DOWNLIGHT C   1005
					
					
DOWNLIGHT C   1006	DOWNLIGHT C   1007	DOWNLIGHT V 100   1008	DOWNLIGHT V 150   1008	DOWNLIGHT V 200   1008	UNIVERSAL DOWNLIGHT   1011
					
					
WATERPROOF V 600   1013	WATERPROOF V DALI 600   1013	WATERPROOF V 1200   1014	WATERPROOF V DALI 1200   1015	WATERPROOF V 1500   1017	WATERPROOF V DALI 1500   1017
					
					
INDUSTRY BATTEN V 1200   1018	INDUSTRY BATTEN V 1500   1019	HIGHBAY C 340   1021	HIGHBAY C 400   1021	HIGHBAY C DALI 400   1021	HIGHBAY V 330   1024
					
					
OUTDOOR BULKHEAD V 360   1027	OUTDOOR BULKHEAD V 360   1027	FLOODI S   1029	FLOODI M   1029	FLOODI L   1029	LED TUBE   1031



MEDO® RING 90  
1008593

A photograph of a dining table set for a meal. The table is dark and reflective, with several wine glasses and a vase of dried flowers. The background is a blurred view of a lake and greenery. A vertical copper-colored rod hangs from the ceiling.

GRIP! L  
1008471





 <b>SCKET</b> KAMI   57	 <b>LED</b> UNIVERSAL DOWNLIGHT   59	 <b>LED</b> KADUX   62	 <b>LED</b> KADUX   63	 <b>LED</b> KADUX   65	 <b>LED</b> KADUX   65
 <b>LED</b> KADUX   66	 <b>SCKET</b> KADUX   66	 <b>SCKET</b> KADUX   66	 <b>SCKET</b> KADUX   66	 <b>SCKET</b> KADUX   67	 <b>SCKET</b> KADUX   67
 <b>LED</b> NUMINOS® XS   69	 <b>LED</b> NUMINOS® S   71	 <b>LED</b> NUMINOS® M   73	 <b>LED</b> NUMINOS® L   75	 <b>LED</b> NUMINOS® XL   77	 <b>LED</b> NUMINOS® MOVE XS   79
 <b>LED</b> NUMINOS® MOVE S   81	 <b>LED</b> NUMINOS® MOVE M   83	 <b>LED</b> NUMINOS® MOVE L   85	 <b>LED</b> NUMINOS® MOVE XL   87	 <b>LED</b> NUMINOS® GIMBLE XS   89	 <b>LED</b> NUMINOS® GIMBLE S   91
 <b>LED</b> NUMINOS® GIMBLE M   93	 <b>LED</b> NUMINOS® GIMBLE L   95	 <b>LED</b> NUMINOS® GIMBLE XL   97	 <b>LED</b> NEW TRIA® 68   104	 <b>LED</b> NEW TRIA® 68   107	 <b>LED</b> NEW TRIA® 75   107
 <b>LED</b> NEW TRIA® 68   109	 <b>LED</b> NEW TRIA® UNIVERSAL 68   111	 <b>SCKET</b> NEW TRIA® 68   113	 <b>SCKET</b> NEW TRIA® 75 / XL   115	 <b>SCKET</b> NEW TRIA®   116	 <b>LED</b> NEW TRIA®   117
 <b>LED</b> NEW TRIA®   118	 <b>LED</b> NEW TRIA® 95   124	 <b>LED</b> NEW TRIA® 155   127	 <b>LED</b> NEW TRIA® 45   130	 <b>SCKET</b> NEW TRIA® 150   131	 <b>SCKET</b> NEW TRIA® 150   131



**SCKET**

NEW TRIA® 300 | 131



NEW

**LED**

MEDO® 30 | 132



NEW

**LED**

MEDO® 40 | 132



NEW

**LED**

MEDO® 60 | 133



NEW

**LED**

MEDO® 90 | 133



NEW

**LED**

MEDO® 30 | 134



NEW

**LED**

MEDO® 40 | 134



NEW

**LED**

MEDO® 60 | 135



NEW

**LED**

MEDO® 90 | 135



**LED**

HORN MINI | 136



**SCKET**

HORN | 137



**SCKET**

HORN | 137



**SCKET**

HORN | 137



**SCKET**

HORN | 138



**SCKET**

HORN | 138



**SCKET**

HORN | 138



**SCKET**

HORN-T | 139



**LED**

HORN MAGNA | 139



**LED**

SENDER 12 | 141



**LED**

SENDER 18 | 141



**LED**

SENDER 24 | 141



**LED**

SENDER 12 | 143



**LED**

SENDER 18 | 143



**LED**

SENDER 24 | 143



**LED**

VERLUX | 145



**LED**

VERLUX | 145



**LED**

DL 126 | 145



**SCKET**

PIKA | 146



**SCKET**

PIKA | 146



**LED**

OCULUS | 147



**LED**

OCCULDAS 14 | 148



**LED**

OCCULDAS 23 | 148



**LED**

CONTONE® | 149



**LED**

CONTONE® | 149



**LED**

KARPO 30 | 150



**SCKET**

PLASTRA | 151



**SCKET**

PLASTRA | 151



**LED**

DEKLED | 152



**SCKET**

VARU | 152



**SCKET**

DOLIX OUT | 153



**SCKET**

DOLIX OUT | 153



**LED**

KAMUELA ECO | 155



LED  
KINI | 155



LED  
AKALO D83 | 155



LED  
FRAME BASIC  
SET | 156



LED  
FRAME BASIC | 156



LED  
FRAME BASIC | 156



LED  
FRAME CURVE | 157



LED  
FRAME CURVE | 157



LED  
NOTAPO S | 159



LED  
NOTAPO L | 159



LED  
DOWNUNDER  
PUR 80 | 160



LED  
DOWNUNDER  
PUR 150 | 160



LED  
MOBALA | 161



LED  
WORO | 161



LED  
PATTA-I | 162



LED  
PATTA-I | 162



LED  
PATTA-I | 163



LED  
PATTA-I | 163



LED  
PATTA-F | 164



LED  
PATTA-F | 165







# KAMI

RL, single, QPAR51

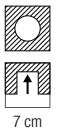
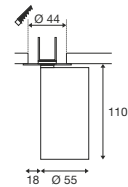

220-240V ~50/60Hz  
Material: alumínio

- Espessura do material da superfície a instalar: máx. 20 mm

**SOCKET INSIDE** 10 W

Casquilho: 1xGU10

Máx. Ø: 5,1 cm

Versão	Art. n.º	EUR
● Preto	1007745	64,00
● Preto/Dourado	1007741	64,00
○ Branco	1007744	64,00
● Branco/Preto	1007742	64,00
○ Branco/Dourado	1007740	64,00



LED QPAR51 | 6W | 38°  
3000K | 450lm | CEE=F  
6kWh/1000h



Art. N.º: 1005080 | 7,50 EUR



1008065 + 1008095 59



1008065 + 1008096 59

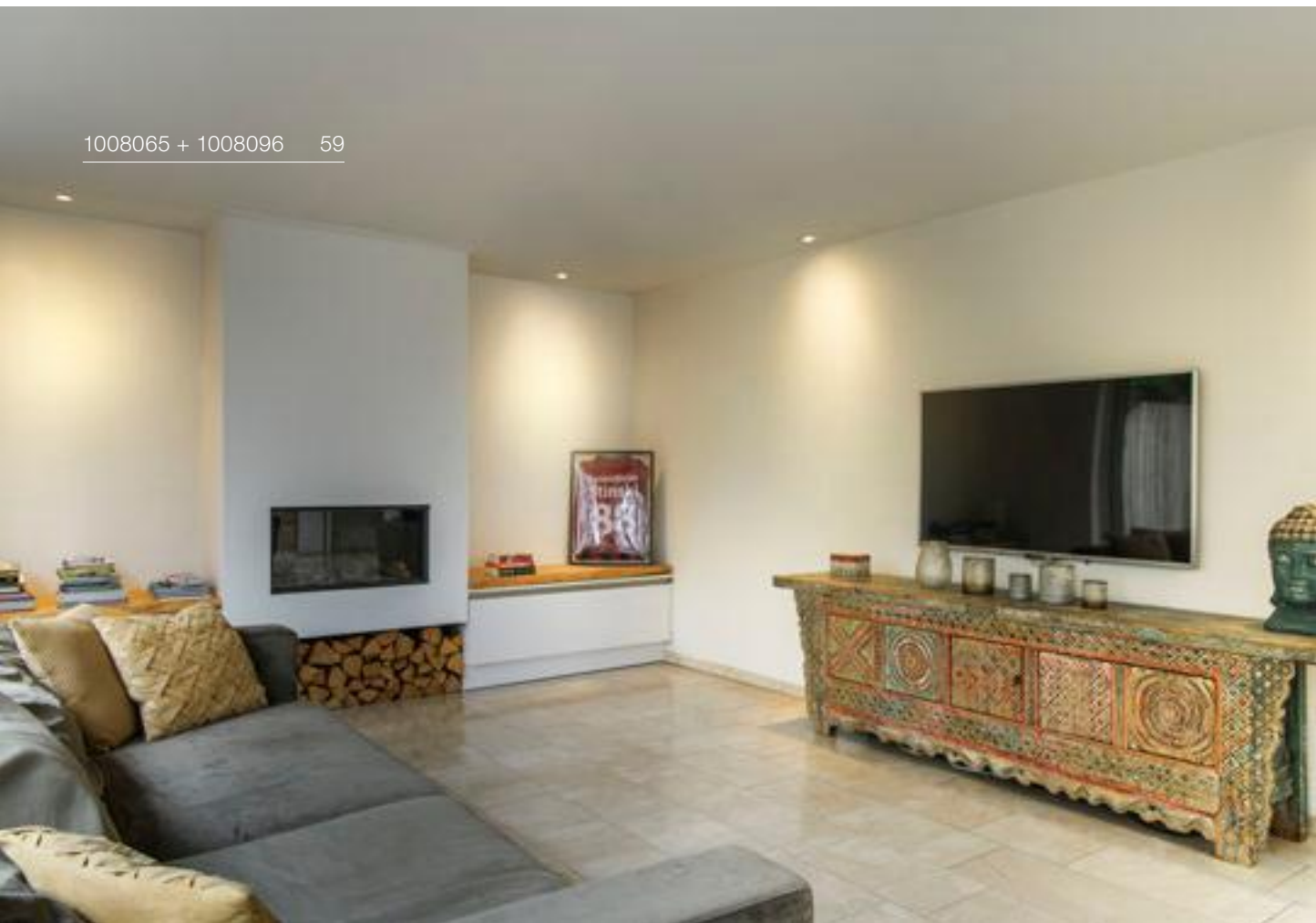

### UNIVERSAL DOWNLIGHT DL, PHASE

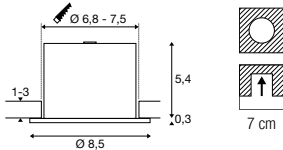

220-240V ~50/60Hz | 60/mA  
Potência do sistema: 5W/7W  
Material: aço

- Espessura do material da superfície a instalar: máx. 30 mm



5W	470lm	2700K
	490lm	3000K
	500lm	4000K
	490lm	6500K
	670lm	2700K
7W	680lm	3000K
	690lm	4000K
	680lm	6500K

Versão	Art. n.º	EUR
● Preto	1008065	27,00

### UNIVERSAL DOWNLIGHT Aro, fixo, redondo



Ø: 8,8 cm  
A: 0,5 cm  
Material: policarbonato (PC)

- IP65 em conjugação com o módulo Universal Downlight

Versão	Art. n.º	EUR
● Preto	1008067	3,00
○ Branco	1008068	3,00
● Dourado mate	1008070	3,50
● Alumínio	1008069	3,50

### UNIVERSAL DOWNLIGHT Aro, fixo, quadrado



C: 8,8 cm  
L: 8,8 cm  
A: 0,55 cm  
Material: policarbonato (PC)

- IP65 em conjugação com o módulo Universal Downlight

Versão	Art. n.º	EUR
● Preto	1008096	3,00
○ Branco	1008095	3,00
● Dourado mate	1008098	3,50
● Alumínio	1008097	3,50

### UNIVERSAL DOWNLIGHT Aro, orientável, redondo



Ø: 8,8 cm  
A: 0,35 cm  
Material: policarbonato (PC)

Versão	Art. n.º	EUR
● Preto	1007091	4,00
○ Branco	1007092	4,00
● Dourado mate	1007191	4,50
● Alumínio	1007093	4,50

### UNIVERSAL DOWNLIGHT Aro, orientável, quadrado



C: 8,8 cm  
L: 8,8 cm  
A: 0,35 cm  
Material: policarbonato (PC)

Versão	Art. n.º	EUR
● Preto	1007184	4,00
○ Branco	1007185	4,00
● Dourado mate	1007194	4,50
● Alumínio	1007186	4,50

# DOWNLIGHT UNIVERSAL: AGORA AINDA MAIS UNIVERSAL

---

- Pode ter utilização universal graças à seleção da temperatura de cor: 2700/3000/4000/6500K e consumo: 5W/7W
- Reprodução cromática natural IRC>90
- Personalizável de acordo com as suas exigências: versão fixa IP65 e versão orientável IP20
- Fácil de instalar, graças ao Quick Connector Box e às molas bloqueáveis
- Possibilidade de integração direta no isolamento ou coberto com material isolante
- Hermético com utilização do aro IP65
- Testado para aplicação em tetos falsos definidos como sendo à prova de fogo

## SELECIONE O SEU FAVORITO...

- 1 Aro (fixo IP65, orientável IP20)
- 2 Formato e cor (preto, branco, alumínio, dourado)
- 3 Temperatura de cor seleccionável (2700, 3000, 4000, 6500K)
- 4 Potência do sistema seleccionável (5W, 7W)



JÁ ESTÁ!

# UNIVERSAL DOWNLIGHT

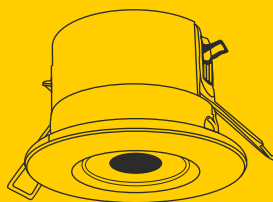

NEW

Instalação fácil com conector rápido e molas



Escolha o aro fixo ou orientável, quadrado ou redondo e nas cores preto, branco, alumínio e dourado



IP65



Versão fixa IP 65 e hermética



IP20



Versão orientável IP20



Temperatura de cor ajustável  
2700K / 3000K / 4000K / 6500K



Potência de sistema ajustável 5W / 7W



Elevada qualidade da luz e reprodução cromática graças ao LED com IRC90

KADUX  
DL, single, DALI



1008572 63

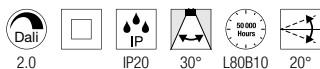
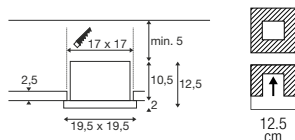

220-240V ~50/60Hz | 700mA  
Potência do sistema: 27W  
Material: alumínio/aço

- Espessura do material da superfície a instalar: máx. 25 mm.



Down 3050lm | 3000K  
3350lm | 4000K

Versão	Art. n.º	EUR
● Preto 3050lm   3000K	1008568	229,00
● Preto 3350lm   4000K	1008570	229,00
○ Branco 3050lm   3000K	1008567	229,00
○ Branco 3350lm   4000K	1008569	229,00





1008571 63

## KADUX DL, double, DALI

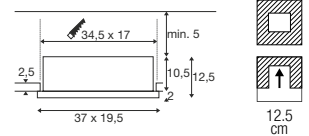

220-240V ~50/60Hz | 1400mA  
Potência do sistema: 54W  
Material: alumínio/aço

- Espessura do material da superfície a instalar: máx. 25 mm.



Down

3400lm | 4000K

Versão	Art. n.º	EUR
● Preto 3150lm   3000K	1008572	● 399,00
● Preto 3400lm   4000K	1008574	● 399,00
○ Branco 3150lm   3000K	1008571	● 399,00
○ Branco 3400lm   4000K	1008573	● 399,00

1007560 65



1007567 65



1007551 65





**KADUX**  
DL, single, PHASE

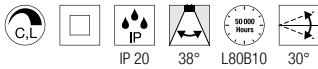
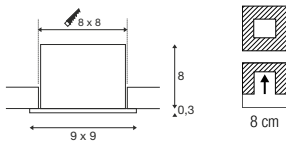

220-240V ~50/60Hz | 350mA  
Potência do sistema: 7,5W  
Material: alumínio/aço

- Molas
- Espessura do material da superfície a instalar: máx. 30 mm



Down 770lm | 3000K

Versão	Art. n.º	EUR
● Preto	1007551	85,00
○ Branco	1007552	85,00

**KADUX**  
DL, double, PHASE

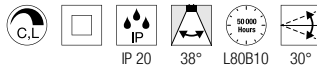
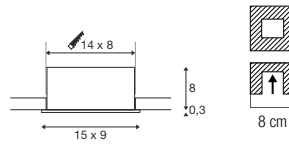

220-240V ~50/60Hz | 350mA  
Potência do sistema: 14W  
Material: alumínio/aço

- Molas
- Espessura do material da superfície a instalar: máx. 30 mm



Down 1550lm | 3000K

Versão	Art. n.º	EUR
● Preto	1007559	160,00
○ Branco	1007560	160,00

**KADUX**  
DL, triple, PHASE

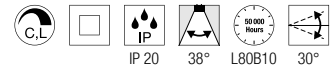
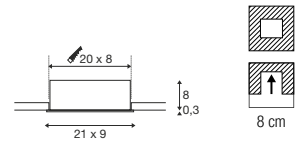

220-240V ~50/60Hz | 350mA  
Potência do sistema: 20W  
Material: alumínio/aço

- Molas
- Espessura do material da superfície a instalar: máx. 30 mm



Down 2350lm | 3000K

Versão	Art. n.º	EUR
● Preto	1007567	211,00
○ Branco	1007568	211,00

KADUX  
EL, single, QPAR51

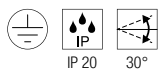
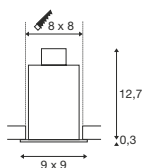

220-240V ~50/60Hz  
Material: alumínio/aço

- Molas
- Espessura do material da superfície a instalar: máx. 30 mm



Casquilho: 1xGU10

Versão	Art. n.º	EUR
● Preto	115510	33,25
○ Branco	115511	33,25



LED GU10 51 mm | 6W | 38°  
2700K | 450lm | CEE=F  
6kWh/1000h



Art. N.º: 1005077 | 7,50 EUR

KADUX  
EL, double, QPAR51

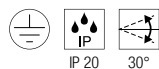
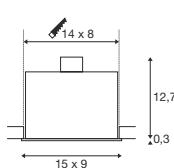

220-240V ~50/60Hz  
Material: alumínio/aço

- Molas
- Espessura do material da superfície a instalar: máx. 30 mm



Casquilho: 2xGU10

Versão	Art. n.º	EUR
● Preto	115520	61,00
○ Branco	115521	61,00



LED GU10 51 mm | 5W | 38°  
2700-6500K | 350lm | CEE=G  
5kWh/1000h



Art. N.º: 1005079 | 7,50 EUR

KADUX  
EL, triple, QPAR51

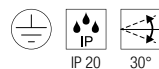
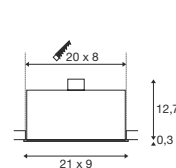

220-240V ~50/60Hz  
Material: alumínio/aço

- Molas
- Espessura do material da superfície a instalar: máx. 30 mm



Casquilho: 3xGU10

Versão	Art. n.º	EUR
● Preto	115530	83,00
○ Branco	115531	83,00



LED GU10 51 mm | 5W | 38°  
2700-6500K | 350lm | CEE=G  
5kWh/1000h



Art. N.º: 1005079 | 7,50 EUR



115550

67

**KADUX**  
EL, single, QPAR111

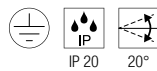
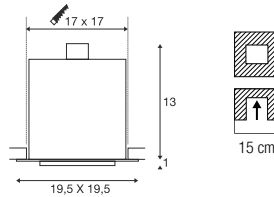

220-240V ~50/60Hz  
Material: alumínio/aço

- Molas
- Espessura do material da superfície a instalar: máx. 25 mm.



Casquilho: 1xGU10

Versão	Art. n.º	EUR
● Preto	115540	107,00
○ Branco	115541	107,00



QPAR111 | 8W | 38°  
2700K | 680lm | CEE=F  
8kWh/1000h



Art. N.º: 1005274 | 29,90 EUR

**KADUX**  
EL, double, QPAR111

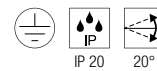
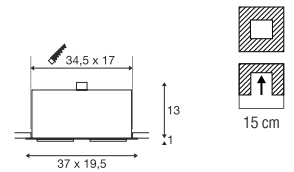

220-240V ~50/60Hz  
Material: alumínio/aço

- Molas
- Espessura do material da superfície a instalar: máx. 25 mm.



Casquilho: 2xGU10

Versão	Art. n.º	EUR
● Preto	115550	164,00
○ Branco	115551	164,00



LED GU10 | 12,5W | 10°  
3000K | 950lm | CEE=F  
13kWh/1000h



Art. N.º: 1005278 | 55,00 EUR



115531

66

# NUMINOS® XS DL

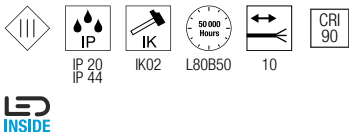
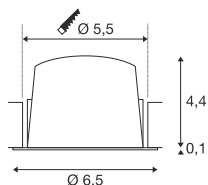

200mA  
Consumo de energia: 7W  
Material: alumínio/policarbonato (PC)

- Espessura do material da superfície a instalar: máx. 25 mm.
- Conector de tensão reduzida
- Driver não incluído

Versão	EUR
Todas as versões XS	69,00

**Nota:**  
A luminária também inclui um conjunto de lamelas que podem ser substituídas (pelas molas).

Encontra o driver, os difusores e anéis redutores adequados nas páginas 98-101.

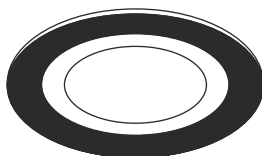

● Preto

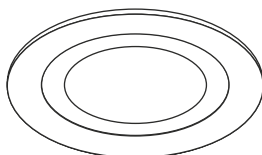

○ Branco



● Preto



○ Branco

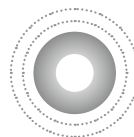

● Cromado



● Preto





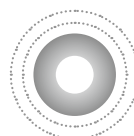





○ Branco



● Cromado



			UGR	Art. N.º	
2700K	640lm	20°	16	<b>1005499</b>	
	620lm	40°	22	<b>1005502</b>	
	640lm	55°	25	<b>1005505</b>	
3000K	700lm	20°	16	<b>1005517</b>	
	670lm	40°	22	<b>1005520</b>	
	690lm	55°	25	<b>1005523</b>	
4000K	720lm	20°	16	<b>1005535</b>	
	700lm	40°	22	<b>1005538</b>	
	710lm	55°	25	<b>1005541</b>	
2700K	670lm	20°	16	<b>1005500</b>	
	650lm	40°	22	<b>1005503</b>	
	670lm	55°	25	<b>1005506</b>	
3000K	730lm	20°	16	<b>1005518</b>	
	700lm	40°	22	<b>1005521</b>	
	720lm	55°	25	<b>1005524</b>	
4000K	750lm	20°	16	<b>1005536</b>	
	730lm	40°	22	<b>1005539</b>	
	740lm	55°	25	<b>1005542</b>	
2700K	670lm	20°	16	<b>1005501</b>	
	650lm	40°	22	<b>1005504</b>	
	670lm	55°	25	<b>1005507</b>	
3000K	730lm	20°	16	<b>1005519</b>	
	700lm	40°	22	<b>1005522</b>	
	720lm	55°	25	<b>1005525</b>	
4000K	750lm	20°	16	<b>1005537</b>	
	730lm	40°	22	<b>1005540</b>	
	740lm	55°	25	<b>1005543</b>	
2700K	640lm	20°	16	<b>1005508</b>	
	620lm	40°	22	<b>1005511</b>	
	640lm	55°	25	<b>1005514</b>	
3000K	700lm	20°	16	<b>1005526</b>	
	670lm	40°	22	<b>1005529</b>	
	690lm	55°	25	<b>1005532</b>	
4000K	720lm	20°	16	<b>1005544</b>	
	700lm	40°	22	<b>1005547</b>	
	710lm	55°	25	<b>1005550</b>	
2700K	670lm	20°	16	<b>1005509</b>	
	650lm	40°	22	<b>1005512</b>	
	670lm	55°	25	<b>1005515</b>	
3000K	730lm	20°	16	<b>1005527</b>	
	700lm	40°	22	<b>1005530</b>	
	720lm	55°	25	<b>1005533</b>	
4000K	750lm	20°	16	<b>1005545</b>	
	730lm	40°	22	<b>1005548</b>	
	740lm	55°	25	<b>1005551</b>	
2700K	670lm	20°	16	<b>1005510</b>	
	650lm	40°	22	<b>1005513</b>	
	670lm	55°	25	<b>1005516</b>	
3000K	730lm	20°	16	<b>1005528</b>	
	700lm	40°	22	<b>1005531</b>	
	720lm	55°	25	<b>1005534</b>	
4000K	750lm	20°	16	<b>1005546</b>	
	730lm	40°	22	<b>1005549</b>	
	740lm	55°	25	<b>1005552</b>	

# NUMINOS® S DL

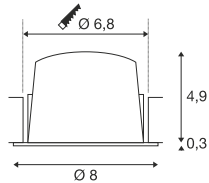

**LED**  
**INSIDE**

250mA  
 Consumo de energia: 8,6W  
 Material: alumínio/policarbonato (PC)

- Espessura do material da superfície a instalar: máx. 25 mm.
- Conector de tensão reduzida
- Driver não incluído

Versão	EUR
Todas as versões S	73,00

**Nota:**  
 A luminária também inclui um conjunto de lamelas que podem ser substituídas (pelas molas).

Encontra o driver, os difusores e anéis redutores adequados nas páginas 98-101.

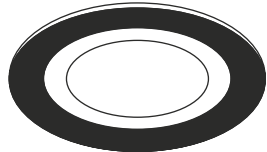

● Preto

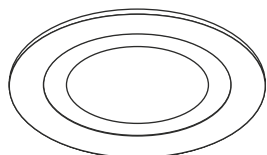

○ Branco



● Preto



○ Branco

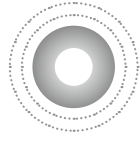

● Cromado



● Preto





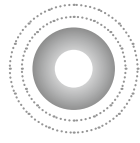





○ Branco



● Cromado



			UGR	Art. N.º	
2700K	670lm	20°	19	<b>1003769</b>	
	670lm	40°	18.5	<b>1003772</b>	
	670lm	55°	22	<b>1003775</b>	
3000K	690lm	20°	19	<b>1003793</b>	
	690lm	40°	19	<b>1003796</b>	
	690lm	55°	22	<b>1003799</b>	
4000K	730lm	20°	19	<b>1003817</b>	
	730lm	40°	19	<b>1003820</b>	
	730lm	55°	22	<b>1003823</b>	
2700K	720lm	20°	18.5	<b>1003770</b>	
	720lm	40°	19	<b>1003773</b>	
	720lm	55°	22	<b>1003776</b>	
3000K	730lm	20°	19	<b>1003794</b>	
	730lm	40°	19	<b>1003797</b>	
	730lm	55°	22	<b>1003800</b>	
4000K	790lm	20°	19	<b>1003818</b>	
	790lm	40°	19	<b>1003821</b>	
	790lm	55°	22	<b>1003824</b>	
2700K	690lm	20°	19	<b>1003771</b>	
	690lm	40°	19	<b>1003774</b>	
	690lm	55°	22	<b>1003777</b>	
3000K	700lm	20°	19	<b>1003795</b>	
	700lm	40°	19	<b>1003798</b>	
	700lm	55°	19	<b>1003801</b>	
4000K	750lm	20°	19	<b>1003819</b>	
	750lm	40°	19	<b>1003822</b>	
	750lm	55°	22	<b>1003825</b>	
2700K	670lm	20°	19	<b>1003781</b>	
	670lm	40°	19	<b>1003784</b>	
	670lm	55°	22	<b>1003787</b>	
3000K	690lm	20°	19	<b>1003805</b>	
	690lm	40°	19	<b>1003808</b>	
	690lm	55°	22	<b>1003811</b>	
4000K	730lm	20°	19	<b>1003829</b>	
	730lm	40°	19	<b>1003832</b>	
	730lm	55°	22	<b>1003835</b>	
2700K	720lm	20°	18.5	<b>1003782</b>	
	720lm	40°	19	<b>1003785</b>	
	720lm	55°	22	<b>1003788</b>	
3000K	730lm	20°	19	<b>1003806</b>	
	730lm	40°	19	<b>1003809</b>	
	730lm	55°	22	<b>1003812</b>	
4000K	790lm	20°	19	<b>1003830</b>	
	790lm	40°	19	<b>1003833</b>	
	790lm	55°	22	<b>1003836</b>	
2700K	690lm	20°	19	<b>1003783</b>	
	690lm	40°	19	<b>1003786</b>	
	690lm	55°	22	<b>1003789</b>	
3000K	700lm	20°	19	<b>1003807</b>	
	700lm	40°	19	<b>1003810</b>	
	700lm	55°	22	<b>1003813</b>	
4000K	750lm	20°	19	<b>1003831</b>	
	750lm	40°	19	<b>1003834</b>	
	750lm	55°	22	<b>1003837</b>	

# NUMINOS® M DL

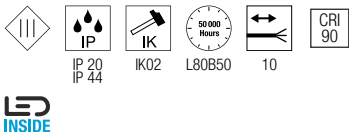
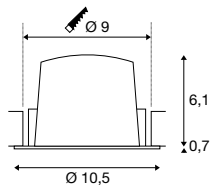

500mA  
Consumo de energia: 17,6W  
Material: alumínio/policarbonato (PC)

- Espessura do material da superfície a instalar: máx. 25 mm.
- Conector de tensão reduzida
- Driver não incluído

Versão	EUR
Todas as versões M	87,00

**Nota:**  
A luminária também inclui um conjunto de lamelas que podem ser substituídas (pelas molas).

Encontra o driver, os difusores e anéis redutores adequados nas páginas 98-101.

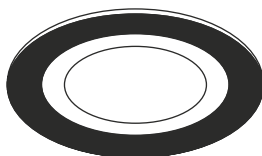

● Preto

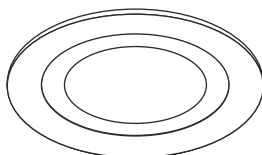

○ Branco



● Preto



○ Branco

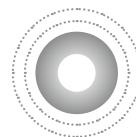

● Cromado



● Preto











○ Branco



● Cromado





			UGR	Art. N.º	
2700K	1460lm	20°	19	<b>1003841</b>	
	1460lm	40°	22	<b>1003844</b>	
	1460lm	55°	22	<b>1003847</b>	
3000K	1500lm	20°	19	<b>1003865</b>	
	1500lm	40°	22	<b>1003868</b>	
	1500lm	55°	22	<b>1003871</b>	
4000K	1600lm	20°	19	<b>1003889</b>	
	1600lm	40°	22	<b>1003892</b>	
	1600lm	55°	22	<b>1003895</b>	
2700K	1600lm	20°	22	<b>1003842</b>	
	1600lm	40°	19.4	<b>1003845</b>	
	1600lm	55°	22	<b>1003848</b>	
3000K	1600lm	20°	22	<b>1003866</b>	
	1600lm	40°	22	<b>1003869</b>	
	1600lm	55°	22	<b>1003872</b>	
4000K	1750lm	20°	22	<b>1003890</b>	
	1750lm	40°	22	<b>1003893</b>	
	1750lm	55°	22	<b>1003896</b>	
2700K	1550lm	20°	19	<b>1003843</b>	
	1550lm	40°	19	<b>1003846</b>	
	1550lm	55°	19	<b>1003849</b>	
3000K	1550lm	20°	19	<b>1003867</b>	
	1550lm	40°	19	<b>1003870</b>	
	1550lm	55°	19	<b>1003873</b>	
4000K	1660lm	20°	19	<b>1003891</b>	
	1660lm	40°	19	<b>1003894</b>	
	1660lm	55°	19	<b>1003897</b>	
2700K	1460lm	20°	19	<b>1003853</b>	
	1460lm	40°	22	<b>1003856</b>	
	1460lm	55°	22	<b>1003859</b>	
3000K	1500lm	20°	19	<b>1003877</b>	
	1500lm	40°	22	<b>1003880</b>	
	1500lm	55°	22	<b>1003883</b>	
4000K	1600lm	20°	19	<b>1003901</b>	
	1600lm	40°	22	<b>1003904</b>	
	1600lm	55°	22	<b>1003907</b>	
2700K	1600lm	20°	22	<b>1003854</b>	
	1600lm	40°	19	<b>1003857</b>	
	1600lm	55°	22	<b>1003860</b>	
3000K	1600lm	20°	22	<b>1003878</b>	
	1600lm	40°	22	<b>1003881</b>	
	1600lm	55°	22	<b>1003884</b>	
4000K	1750lm	20°	22	<b>1003902</b>	
	1750lm	40°	22	<b>1003905</b>	
	1750lm	55°	22	<b>1003908</b>	
2700K	1550lm	20°	19	<b>1003855</b>	
	1550lm	40°	19	<b>1003858</b>	
	1550lm	55°	19	<b>1003861</b>	
3000K	1550lm	20°	19	<b>1003879</b>	
	1550lm	40°	19	<b>1003882</b>	
	1550lm	55°	19	<b>1003885</b>	
4000K	1660lm	20°	19	<b>1003903</b>	
	1660lm	40°	19	<b>1003906</b>	
	1660lm	55°	19	<b>1003909</b>	

# NUMINOS® L DL

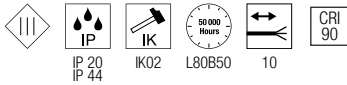
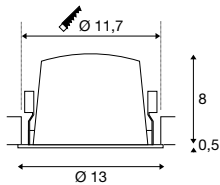

700mA  
Consumo de energia: 25,4W  
Material: alumínio/policarbonato (PC)

- Espessura do material da superfície a instalar: máx. 25 mm.
- Conector de tensão reduzida
- Driver não incluído

Versão	EUR
Todas as versões L	106,00

**Nota:**  
A luminária também inclui um conjunto de lamelas que podem ser substituídas (pelas molas).

Encontra o driver, os difusores e anéis redutores adequados nas páginas 98-101.

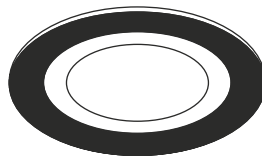

● Preto

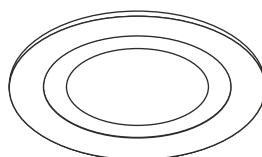

○ Branco



● Preto



○ Branco

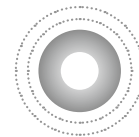

● Cromado



● Preto





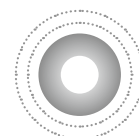





○ Branco



● Cromado



			UGR	Art. N.º	
2700K	2150lm	20°	22	<b>1003913</b>	
	2150lm	40°	22	<b>1003916</b>	
	2150lm	55°	22	<b>1003919</b>	
3000K	2150lm	20°	22	<b>1003937</b>	
	2150lm	40°	22	<b>1003940</b>	
	2150lm	55°	25	<b>1003943</b>	
4000K	2350lm	20°	22	<b>1003961</b>	
	2350lm	40°	22	<b>1003964</b>	
	2350lm	55°	25	<b>1003967</b>	
2700K	2250lm	20°	19	<b>1003914</b>	
	2250lm	40°	19	<b>1003917</b>	
	2250lm	55°	22	<b>1003920</b>	
3000K	2300lm	20°	19	<b>1003938</b>	
	2300lm	40°	19	<b>1003941</b>	
	2300lm	55°	20	<b>1003944</b>	
4000K	2450lm	20°	19	<b>1003962</b>	
	2450lm	40°	19	<b>1003965</b>	
	2450lm	55°	22	<b>1003968</b>	
2700K	2150lm	20°	19	<b>1003915</b>	
	2150lm	40°	19	<b>1003918</b>	
	2150lm	55°	19	<b>1003921</b>	
3000K	2200lm	20°	19	<b>1003939</b>	
	2200lm	40°	19	<b>1003942</b>	
	2200lm	55°	19	<b>1003945</b>	
4000K	2350lm	20°	19	<b>1003963</b>	
	2350lm	40°	19	<b>1003966</b>	
	2350lm	55°	19	<b>1003969</b>	
2700K	2150lm	20°	22	<b>1003925</b>	
	2150lm	40°	22	<b>1003928</b>	
	2150lm	55°	22	<b>1003931</b>	
3000K	2150lm	20°	22	<b>1003949</b>	
	2150lm	40°	22	<b>1003952</b>	
	2150lm	55°	25	<b>1003955</b>	
4000K	2350lm	20°	22	<b>1003973</b>	
	2350lm	40°	22	<b>1003976</b>	
	2350lm	55°	25	<b>1003979</b>	
2700K	2250lm	20°	19	<b>1003926</b>	
	2250lm	40°	19	<b>1003929</b>	
	2250lm	55°	22	<b>1003932</b>	
3000K	2300lm	20°	19	<b>1003950</b>	
	2300lm	40°	19	<b>1003953</b>	
	2300lm	55°	22	<b>1003956</b>	
4000K	2450lm	20°	19	<b>1003974</b>	
	2450lm	40°	19	<b>1003977</b>	
	2450lm	55°	22	<b>1003980</b>	
2700K	2150lm	20°	19	<b>1003927</b>	
	2150lm	40°	19	<b>1003930</b>	
	2150lm	55°	19	<b>1003933</b>	
3000K	2200lm	20°	19	<b>1003951</b>	
	2200lm	40°	19	<b>1003954</b>	
	2200lm	55°	19	<b>1003957</b>	
4000K	2350lm	20°	19	<b>1003975</b>	
	2350lm	40°	19	<b>1003978</b>	
	2350lm	55°	19	<b>1003981</b>	

NUMINOS® XL  
DL

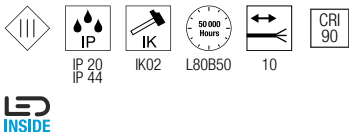
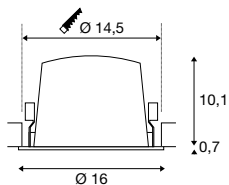

1050mA  
Consumo de energia: 37,4W  
Material: alumínio/policarbonato (PC)

- Espessura do material da superfície a instalar: máx. 25 mm.
- Conector de tensão reduzida
- Driver não incluído

Versão	EUR
Todas as versões XL	132,00

**Nota:**  
A luminária também inclui um conjunto de lamelas que podem ser substituídas (pelas molas).

Encontra o driver, os difusores e anéis redutores adequados nas páginas 98-101.

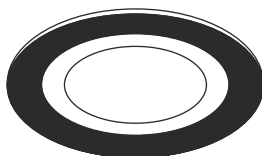

● Preto

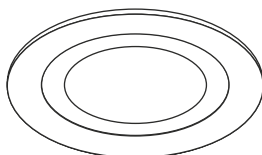

○ Branco



● Preto



○ Branco



● Cromado



● Preto





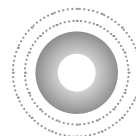





○ Branco



● Cromado



			UGR	Art. N.º	
2700K	3300lm	20°	22	<b>1003985</b>	
	3300lm	40°	22	<b>1003988</b>	
	3300lm	55°	22	<b>1003991</b>	
3000K	3300lm	20°	22	<b>1004009</b>	
	3300lm	40°	22	<b>1004012</b>	
	3300lm	55°	22	<b>1004015</b>	
4000K	3600lm	20°	22	<b>1004033</b>	
	3600lm	40°	22	<b>1004036</b>	
	3600lm	55°	25	<b>1004039</b>	
2700K	3500lm	20°	19	<b>1003986</b>	
	3500lm	40°	19	<b>1003989</b>	
	3500lm	55°	19	<b>1003992</b>	
3000K	3550lm	20°	19	<b>1004010</b>	
	3550lm	40°	19	<b>1004013</b>	
	3550lm	55°	19	<b>1004016</b>	
4000K	3800lm	20°	19	<b>1004034</b>	
	3800lm	40°	19	<b>1004037</b>	
	3800lm	55°	19	<b>1004040</b>	
2700K	3400lm	20°	19	<b>1003987</b>	
	3400lm	40°	19	<b>1003990</b>	
	3400lm	55°	19	<b>1003993</b>	
3000K	3500lm	20°	19	<b>1004011</b>	
	3500lm	40°	19	<b>1004014</b>	
	3500lm	55°	19	<b>1004017</b>	
4000K	3750lm	20°	19	<b>1004035</b>	
	3750lm	40°	19	<b>1004038</b>	
	3750lm	55°	19	<b>1004041</b>	
2700K	3300lm	20°	22	<b>1003997</b>	
	3300lm	40°	22	<b>1004000</b>	
	3300lm	55°	22	<b>1004003</b>	
3000K	3300lm	20°	22	<b>1004021</b>	
	3300lm	40°	22	<b>1004024</b>	
	3300lm	55°	22	<b>1004027</b>	
4000K	3600lm	20°	22	<b>1004045</b>	
	3600lm	40°	22	<b>1004048</b>	
	3600lm	55°	25	<b>1004051</b>	
2700K	3500lm	20°	19	<b>1003998</b>	
	3500lm	40°	19	<b>1004001</b>	
	3500lm	55°	19	<b>1004004</b>	
3000K	3550lm	20°	19	<b>1004022</b>	
	3550lm	40°	19	<b>1004025</b>	
	3550lm	55°	19	<b>1004028</b>	
4000K	3800lm	20°	19	<b>1004046</b>	
	3800lm	40°	19	<b>1004049</b>	
	3800lm	55°	19	<b>1004052</b>	
2700K	3400lm	20°	19	<b>1003999</b>	
	3400lm	40°	19	<b>1004002</b>	
	3400lm	55°	19	<b>1004005</b>	
3000K	3500lm	20°	19	<b>1004023</b>	
	3500lm	40°	19	<b>1004026</b>	
	3500lm	55°	19	<b>1004029</b>	
4000K	3750lm	20°	19	<b>1004047</b>	
	3750lm	40°	19	<b>1004050</b>	
	3750lm	55°	19	<b>1004053</b>	

# NUMINOS® MOVE XS DL

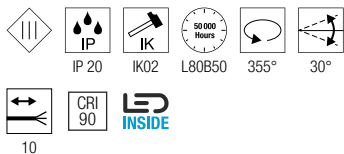
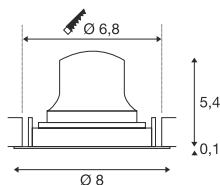

200mA  
Consumo de energia: 7W  
Material: alumínio/policarbonato (PC)

- Espessura do material da superfície a instalar: máx. 25 mm.
- Conector de tensão reduzida
- Driver não incluído

Versão	EUR
Todas as versões XS	84,00

**Nota:**  
A luminária também inclui um conjunto de lamelas que podem ser substituídas (pelas molas).

Encontra o driver, os difusores e anéis redutores adequados nas páginas 98-101.

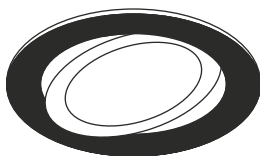

● Preto

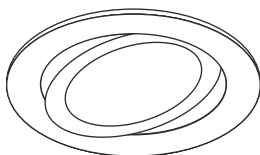

○ Branco



● Preto



○ Branco

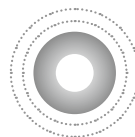

● Cromado



● Preto





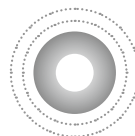





○ Branco



● Cromado



			UGR	Art. N.º	
2700K	640lm	20°	16	<b>1005553</b>	
	620lm	40°	22	<b>1005556</b>	
	640lm	55°	25	<b>1005559</b>	
3000K	700lm	20°	16	<b>1005571</b>	
	670lm	40°	22	<b>1005574</b>	
	690lm	55°	25	<b>1005577</b>	
4000K	720lm	20°	16	<b>1005589</b>	
	700lm	40°	22	<b>1005592</b>	
	710lm	55°	25	<b>1005595</b>	
2700K	670lm	20°	16	<b>1005554</b>	
	650lm	40°	22	<b>1005557</b>	
	670lm	55°	25	<b>1005560</b>	
3000K	730lm	20°	16	<b>1005572</b>	
	700lm	40°	22	<b>1005575</b>	
	720lm	55°	25	<b>1005578</b>	
4000K	750lm	20°	16	<b>1005590</b>	
	730lm	40°	22	<b>1005593</b>	
	740lm	55°	25	<b>1005596</b>	
2700K	670lm	20°	16	<b>1005555</b>	
	650lm	40°	22	<b>1005558</b>	
	670lm	55°	25	<b>1005561</b>	
3000K	730lm	20°	16	<b>1005573</b>	
	700lm	40°	22	<b>1005576</b>	
	720lm	55°	25	<b>1005579</b>	
4000K	750lm	20°	16	<b>1005591</b>	
	730lm	40°	22	<b>1005594</b>	
	740lm	55°	25	<b>1005597</b>	
2700K	640lm	20°	16	<b>1005562</b>	
	620lm	40°	22	<b>1005565</b>	
	640lm	55°	25	<b>1005568</b>	
3000K	700lm	20°	16	<b>1005580</b>	
	670lm	40°	22	<b>1005583</b>	
	690lm	55°	25	<b>1005586</b>	
4000K	720lm	20°	16	<b>1005598</b>	
	700lm	40°	22	<b>1005603</b>	
	710lm	55°	25	<b>1005606</b>	
2700K	670lm	20°	16	<b>1005563</b>	
	650lm	40°	22	<b>1005566</b>	
	670lm	55°	25	<b>1005569</b>	
3000K	730lm	20°	16	<b>1005581</b>	
	700lm	40°	22	<b>1005584</b>	
	720lm	55°	25	<b>1005587</b>	
4000K	750lm	20°	16	<b>1005599</b>	
	730lm	40°	22	<b>1005604</b>	
	740lm	55°	25	<b>1005607</b>	
2700K	670lm	20°	16	<b>1005564</b>	
	650lm	40°	22	<b>1005567</b>	
	670lm	55°	25	<b>1005570</b>	
3000K	730lm	20°	16	<b>1005582</b>	
	700lm	40°	22	<b>1005585</b>	
	720lm	55°	25	<b>1005588</b>	
4000K	750lm	20°	16	<b>1005600</b>	
	730lm	40°	22	<b>1005605</b>	
	740lm	55°	25	<b>1005608</b>	

# NUMINOS® MOVE S DL

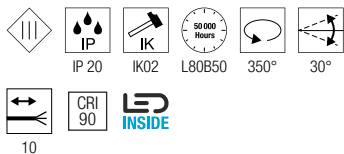
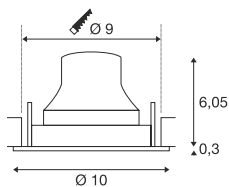

250mA  
Consumo de energia: 8,6W  
Material: alumínio/policarbonato (PC)

- Espessura do material da superfície a instalar: máx. 25 mm.
- Conector de tensão reduzida
- Driver não incluído

Versão	EUR
Todas as versões S	92,00

**Nota:**  
A luminária também inclui um conjunto de lamelas que podem ser substituídas (pelas molas).

Encontra o driver, os difusores e anéis redutores adequados nas páginas 98-101.

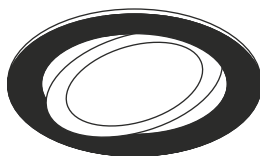

● Preto

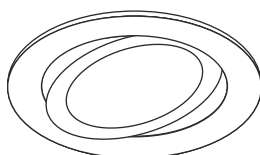

○ Branco



● Preto



○ Branco

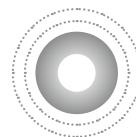

● Cromado



● Preto





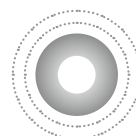





○ Branco



● Cromado





			UGR	Art. N.º	
2700K	670lm	20°	19	<b>1005319</b>	
	670lm	40°	19	<b>1005322</b>	
	670lm	55°	22	<b>1005325</b>	
3000K	690lm	20°	19	<b>1005337</b>	
	690lm	40°	19	<b>1005340</b>	
	690lm	55°	22	<b>1005343</b>	
4000K	730lm	20°	19	<b>1005355</b>	
	730lm	40°	19	<b>1005358</b>	
	730lm	55°	22	<b>1005361</b>	
2700K	720lm	20°	19	<b>1005320</b>	
	720lm	40°	19	<b>1005323</b>	
	720lm	55°	22	<b>1005326</b>	
3000K	730lm	20°	19	<b>1005338</b>	
	730lm	40°	19	<b>1005341</b>	
	730lm	55°	22	<b>1005344</b>	
4000K	790lm	20°	19	<b>1005356</b>	
	790lm	40°	19	<b>1005359</b>	
	790lm	55°	22	<b>1005362</b>	
2700K	690lm	20°	19	<b>1005321</b>	
	690lm	40°	19	<b>1005324</b>	
	690lm	55°	22	<b>1005327</b>	
3000K	700lm	20°	19	<b>1005339</b>	
	700lm	40°	19	<b>1005342</b>	
	700lm	55°	22	<b>1005345</b>	
4000K	750lm	20°	19	<b>1005357</b>	
	750lm	40°	19	<b>1005360</b>	
	750lm	55°	22	<b>1005363</b>	
2700K	670lm	20°	19	<b>1005328</b>	
	670lm	40°	19	<b>1005331</b>	
	670lm	55°	22	<b>1005334</b>	
3000K	690lm	20°	19	<b>1005346</b>	
	690lm	40°	19	<b>1005349</b>	
	690lm	55°	22	<b>1005352</b>	
4000K	730lm	20°	19	<b>1005364</b>	
	730lm	40°	19	<b>1005367</b>	
	730lm	55°	22	<b>1005370</b>	
2700K	720lm	20°	19	<b>1005329</b>	
	720lm	40°	19	<b>1005332</b>	
	720lm	55°	22	<b>1005335</b>	
3000K	730lm	20°	19	<b>1005347</b>	
	730lm	40°	19	<b>1005350</b>	
	730lm	55°	22	<b>1005353</b>	
4000K	790lm	20°	19	<b>1005365</b>	
	790lm	40°	19	<b>1005368</b>	
	790lm	55°	22	<b>1005371</b>	
2700K	690lm	20°	19	<b>1005330</b>	
	690lm	40°	19	<b>1005333</b>	
	690lm	55°	22	<b>1005336</b>	
3000K	700lm	20°	19	<b>1005348</b>	
	700lm	40°	19	<b>1005351</b>	
	700lm	55°	22	<b>1005354</b>	
4000K	750lm	20°	19	<b>1005366</b>	
	750lm	40°	19	<b>1005369</b>	
	750lm	55°	22	<b>1005372</b>	

NUMINOS® MOVE M  
DL

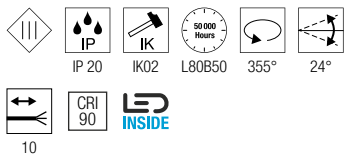
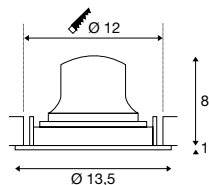

500mA  
Consumo de energia: 17,6W  
Material: alumínio/policarbonato (PC)

- Espessura do material da superfície a instalar: máx. 25 mm.
- Conector de tensão reduzida
- Driver não incluído

Versão	EUR
Todas as versões M	102,00

**Nota:**  
Encontra o driver, os difusores e anéis redutores adequados nas páginas 98-101.

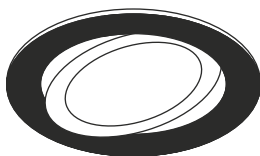

● Preto

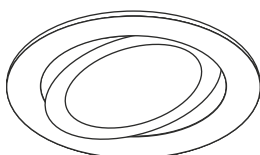

○ Branco



● Preto



○ Branco

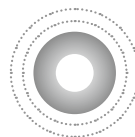

● Cromado



● Preto





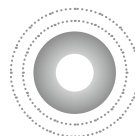



○ Branco



● Cromado



			UGR	Art. N.º	
2700K	1460lm	20°	19	<b>1003553</b>	
	1460lm	40°	22	<b>1003556</b>	
	1460lm	55°	22	<b>1003559</b>	
3000K	1500lm	20°	19	<b>1003577</b>	
	1500lm	40°	22	<b>1003580</b>	
	1500lm	55°	22	<b>1003583</b>	
4000K	1600lm	20°	19	<b>1003601</b>	
	1600lm	40°	22	<b>1003604</b>	
	1600lm	55°	22	<b>1003607</b>	
2700K	1600lm	20°	22	<b>1003554</b>	
	1600lm	40°	19	<b>1003557</b>	
	1600lm	55°	22	<b>1003560</b>	
3000K	1600lm	20°	22	<b>1003578</b>	
	1600lm	40°	22	<b>1003581</b>	
4000K	1600lm	55°	22	<b>1003584</b>	
	1750lm	20°	22	<b>1003602</b>	
	1750lm	40°	22	<b>1003605</b>	
4000K	1750lm	55°	22	<b>1003608</b>	
	1550lm	20°	19	<b>1003555</b>	
	1550lm	40°	19	<b>1003558</b>	
2700K	1550lm	55°	19	<b>1003561</b>	
	1550lm	20°	19	<b>1003579</b>	
	1550lm	40°	19	<b>1003582</b>	
3000K	1550lm	55°	19	<b>1003585</b>	
	1660lm	20°	19	<b>1003603</b>	
4000K	1660lm	40°	19	<b>1003606</b>	
	1660lm	55°	19	<b>1003609</b>	
	2700K	1460lm	20°	19	<b>1003565</b>
1460lm		40°	22	<b>1003568</b>	
1460lm		55°	22	<b>1003571</b>	
3000K	1500lm	20°	19	<b>1003589</b>	
	1500lm	40°	22	<b>1003592</b>	
	1500lm	55°	22	<b>1003595</b>	
4000K	1600lm	20°	19	<b>1003613</b>	
	1600lm	40°	22	<b>1003616</b>	
	1600lm	55°	22	<b>1003619</b>	
2700K	1600lm	20°	22	<b>1003566</b>	
	1600lm	40°	22	<b>1003569</b>	
	1600lm	55°	22	<b>1003572</b>	
3000K	1600lm	20°	22	<b>1003590</b>	
	1600lm	40°	22	<b>1003593</b>	
	1600lm	55°	22	<b>1003596</b>	
4000K	1750lm	20°	22	<b>1003614</b>	
	1750lm	40°	22	<b>1003617</b>	
	1750lm	55°	22	<b>1003620</b>	
2700K	1550lm	20°	19	<b>1003567</b>	
	1550lm	40°	19	<b>1003570</b>	
	1550lm	55°	19	<b>1003573</b>	
3000K	1550lm	20°	19	<b>1003591</b>	
	1550lm	40°	19	<b>1003594</b>	
4000K	1550lm	55°	19	<b>1003597</b>	
	1660lm	20°	19	<b>1003615</b>	
	1660lm	40°	19	<b>1003618</b>	
	1660lm	55°	19	<b>1003621</b>	

# NUMINOS® MOVE L DL

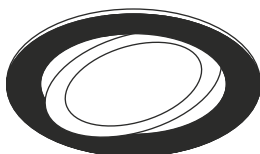

● Preto

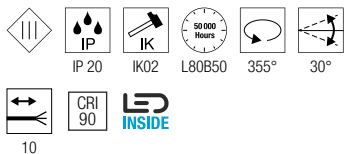
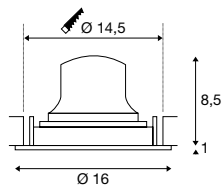

700mA  
Consumo de energia: 25,4W  
Material: alumínio/policarbonato (PC)

- Espessura do material da superfície a instalar: máx. 25 mm.
- Conector de tensão reduzida
- Driver não incluído

Versão	EUR
Todas as versões L	122,00

**Nota:**  
Encontra o driver, os difusores e anéis redutores adequados nas páginas 98-101.



● Preto



○ Branco

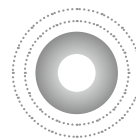

● Cromado



● Preto

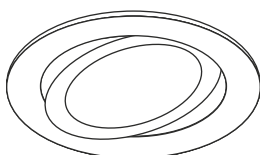

○ Branco





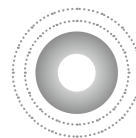





○ Branco



● Cromado



			UGR	Art. N.º	
2700K	2150lm	20°	22	<b>1003625</b>	
	2150lm	40°	22	<b>1003628</b>	
	2150lm	55°	22	<b>1003631</b>	
3000K	2150lm	20°	22	<b>1003649</b>	
	2150lm	40°	22	<b>1003652</b>	
	2150lm	55°	25	<b>1003655</b>	
4000K	2350lm	20°	22	<b>1003673</b>	
	2350lm	40°	22	<b>1003676</b>	
	2350lm	55°	25	<b>1003679</b>	
2700K	2250lm	20°	19	<b>1003626</b>	
	2250lm	40°	19	<b>1003629</b>	
	2250lm	55°	22	<b>1003632</b>	
3000K	2300lm	20°	19	<b>1003650</b>	
	2300lm	40°	19	<b>1003653</b>	
	2300lm	55°	22	<b>1003656</b>	
4000K	2450lm	20°	19	<b>1003674</b>	
	2450lm	40°	19	<b>1003677</b>	
	2450lm	55°	22	<b>1003680</b>	
2700K	2150lm	20°	19	<b>1003627</b>	
	2150lm	40°	19	<b>1003630</b>	
	2150lm	55°	19	<b>1003633</b>	
3000K	2200lm	20°	19	<b>1003651</b>	
	2200lm	40°	19	<b>1003654</b>	
	2200lm	55°	19	<b>1003657</b>	
4000K	2350lm	20°	19	<b>1003675</b>	
	2350lm	40°	19	<b>1003678</b>	
	2350lm	55°	19	<b>1003681</b>	
2700K	2150lm	20°	22	<b>1003637</b>	
	2150lm	40°	22	<b>1003640</b>	
	2150lm	55°	22	<b>1003643</b>	
3000K	2150lm	20°	22	<b>1003661</b>	
	2150lm	40°	22	<b>1003664</b>	
	2150lm	55°	25	<b>1003667</b>	
4000K	2350lm	20°	22	<b>1003685</b>	
	2350lm	40°	22	<b>1003688</b>	
	2350lm	55°	25	<b>1003691</b>	
2700K	2250lm	20°	19	<b>1003638</b>	
	2250lm	40°	19	<b>1003641</b>	
	2250lm	55°	22	<b>1003644</b>	
3000K	2300lm	20°	19	<b>1003662</b>	
	2300lm	40°	19	<b>1003665</b>	
	2300lm	55°	22	<b>1003668</b>	
4000K	2450lm	20°	19	<b>1003686</b>	
	2450lm	40°	19	<b>1003689</b>	
	2450lm	55°	22	<b>1003692</b>	
2700K	2150lm	20°	19	<b>1003639</b>	
	2150lm	40°	19	<b>1003642</b>	
	2150lm	55°	19	<b>1003645</b>	
3000K	2200lm	20°	19	<b>1003663</b>	
	2200lm	40°	19	<b>1003666</b>	
	2200lm	55°	19	<b>1003669</b>	
4000K	2350lm	20°	19	<b>1003687</b>	
	2350lm	40°	19	<b>1003690</b>	
	2350lm	55°	19	<b>1003693</b>	

NUMINOS® MOVE XL  
DL

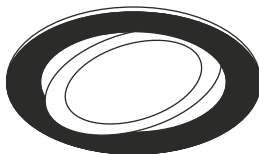

● Preto

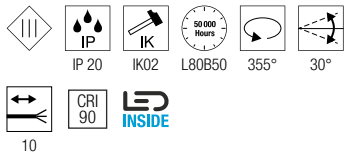
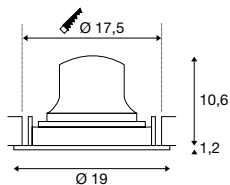

1050mA  
Consumo de energia: 37,4W  
Material: alumínio/policarbonato (PC)

- Espessura do material da superfície a instalar: máx. 25 mm.
- Conector de tensão reduzida
- Driver não incluído

Versão	EUR
Todas as versões XL	152,00

**Nota:**  
Encontra o driver, os difusores e anéis redutores adequados nas páginas 98-101.



● Preto



○ Branco



● Cromado



● Preto













○ Branco



● Cromado



					Art. N.º	
2700K		3300lm	20°	22	<b>1003697</b>	
		3300lm	40°	22	<b>1003700</b>	
		3300lm	55°	22	<b>1003703</b>	
3000K		3300lm	20°	22	<b>1003721</b>	
		3300lm	40°	22	<b>1003724</b>	
		3300lm	55°	22	<b>1003727</b>	
4000K		3600lm	20°	22	<b>1003745</b>	
		3600lm	40°	22	<b>1003748</b>	
		3600lm	55°	25	<b>1003751</b>	
2700K		3500lm	20°	19	<b>1003698</b>	
		3500lm	40°	19	<b>1003701</b>	
		3500lm	55°	19	<b>1003704</b>	
3000K		3550lm	20°	19	<b>1003722</b>	
		3550lm	40°	19	<b>1003725</b>	
		3550lm	55°	19	<b>1003728</b>	
4000K		3800lm	20°	19	<b>1003746</b>	
		3800lm	40°	19	<b>1003749</b>	
		3800lm	55°	19	<b>1003752</b>	
2700K		3400lm	20°	19	<b>1003699</b>	
		3400lm	40°	19	<b>1003702</b>	
		3400lm	55°	19	<b>1003705</b>	
3000K		3500lm	20°	19	<b>1003723</b>	
		3500lm	40°	19	<b>1003726</b>	
		3500lm	55°	19	<b>1003729</b>	
4000K		3750lm	20°	19	<b>1003747</b>	
		3750lm	40°	19	<b>1003750</b>	
		3750lm	55°	19	<b>1003753</b>	
2700K		3300lm	20°	22	<b>1003709</b>	
		3300lm	40°	22	<b>1003712</b>	
		3300lm	55°	22	<b>1003715</b>	
3000K		3300lm	20°	22	<b>1003733</b>	
		3300lm	40°	22	<b>1003736</b>	
		3300lm	55°	22	<b>1003739</b>	
4000K		3600lm	20°	22	<b>1003757</b>	
		3600lm	40°	22	<b>1003760</b>	
		3600lm	55°	25	<b>1003763</b>	
2700K		3500lm	20°	19	<b>1003710</b>	
		3500lm	40°	19	<b>1003713</b>	
		3500lm	55°	19	<b>1003716</b>	
3000K		3550lm	20°	19	<b>1003734</b>	
		3550lm	40°	19	<b>1003737</b>	
		3550lm	55°	19	<b>1003740</b>	
4000K		3800lm	20°	19	<b>1003758</b>	
		3800lm	40°	19	<b>1003761</b>	
		3800lm	55°	19	<b>1003764</b>	
2700K		3400lm	20°	19	<b>1003711</b>	
		3400lm	40°	19	<b>1003714</b>	
		3400lm	55°	19	<b>1003717</b>	
3000K		3500lm	20°	19	<b>1003735</b>	
		3500lm	40°	19	<b>1003738</b>	
		3500lm	55°	19	<b>1003741</b>	
4000K		3750lm	20°	19	<b>1003759</b>	
		3750lm	40°	19	<b>1003762</b>	
		3750lm	55°	19	<b>1003765</b>	

# NUMINOS® GIMBLE XS DL



● Preto

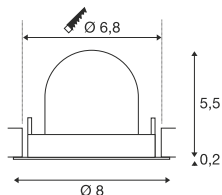

200mA  
Consumo de energia: 7W  
Material: alumínio/policarbonato (PC)

- Espessura do material da superfície a instalar: máx. 25 mm.
- Conector de tensão reduzida
- Driver não incluído

Versão	EUR
Todas as versões XS	92,00

**Nota:**  
A luminária também inclui um conjunto de lamelas que podem ser substituídas (pelas molas).

Encontra o driver, os difusores e anéis redutores adequados nas páginas 98-101.



● Preto



○ Branco

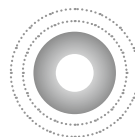

● Cromado



● Preto

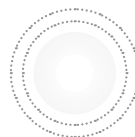



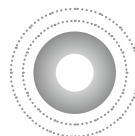





○ Branco



● Cromado





			UGR	Art. N.º		
2700K	640lm	20°	16	<b>1005813</b>		
	620lm	40°	22	<b>1005816</b>		
	640lm	55°	25	<b>1005819</b>		
3000K	700lm	20°	16	<b>1005831</b>		
	670lm	40°	22	<b>1005834</b>		
	690lm	55°	25	<b>1005837</b>		
4000K	720lm	20°	16	<b>1005849</b>		
	700lm	40°	22	<b>1005852</b>		
	710lm	55°	25	<b>1005855</b>		
2700K	670lm	20°	16	<b>1005814</b>		
	650lm	40°	22	<b>1005817</b>		
	670lm	55°	25	<b>1005820</b>		
3000K	730lm	20°	16	<b>1005832</b>		
	700lm	40°	22	<b>1005835</b>		
	720lm	55°	25	<b>1005838</b>		
4000K	750lm	20°	16	<b>1005850</b>		
	730lm	40°	22	<b>1005853</b>		
	740lm	55°	25	<b>1005856</b>		
2700K	670lm	20°	16	<b>1005815</b>		
	650lm	40°	22	<b>1005818</b>		
	670lm	55°	25	<b>1005821</b>		
3000K	730lm	20°	16	<b>1005833</b>		
	700lm	40°	22	<b>1005836</b>		
	720lm	55°	25	<b>1005839</b>		
4000K	750lm	20°	16	<b>1005851</b>		
	730lm	40°	22	<b>1005854</b>		
	740lm	55°	25	<b>1005857</b>		
2700K	640lm	20°	16	<b>1005822</b>		
	620lm	40°	22	<b>1005825</b>		
	640lm	55°	25	<b>1005828</b>		
3000K	700lm	20°	16	<b>1005840</b>		
	670lm	40°	22	<b>1005843</b>		
	690lm	55°	25	<b>1005846</b>		
4000K	720lm	20°	16	<b>1005858</b>		
	700lm	40°	22	<b>1005861</b>		
	710lm	55°	25	<b>1005864</b>		
2700K	670lm	20°	16	<b>1005823</b>		
	650lm	40°	22	<b>1005826</b>		
	670lm	55°	25	<b>1005829</b>		
3000K	730lm	20°	16	<b>1005841</b>		
	700lm	40°	22	<b>1005844</b>		
	720lm	55°	25	<b>1005847</b>		
4000K	750lm	20°	16	<b>1005859</b>		
	730lm	40°	22	<b>1005862</b>		
	740lm	55°	25	<b>1005865</b>		
2700K	670lm	20°	16	<b>1005824</b>		
	650lm	40°	22	<b>1005827</b>		
	670lm	55°	25	<b>1005830</b>		
3000K	730lm	20°	16	<b>1005842</b>		
	700lm	40°	22	<b>1005845</b>		
	720lm	55°	25	<b>1005848</b>		
4000K	750lm	20°	16	<b>1005860</b>		
	730lm	40°	22	<b>1005863</b>		
	740lm	55°	25	<b>1005866</b>		

# NUMINOS® GIMBLE S DL



● Preto

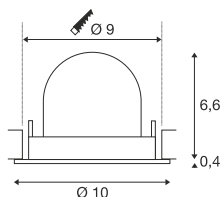

250mA  
Consumo de energia: 8,6W  
Material: alumínio/policarbonato (PC)

- Espessura do material da superfície a instalar: máx. 25 mm.
- Conector de tensão reduzida
- Driver não incluído

Versão	EUR
Todas as versões S	102,00

**Nota:**  
A luminária também inclui um conjunto de lamelas que podem ser substituídas (pelas molas).

Encontra o driver, os difusores e anéis redutores adequados nas páginas 98-101.



● Preto



○ Branco

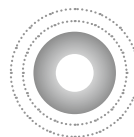

● Cromado



● Preto





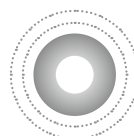





○ Branco



● Cromado



			UGR	Art. N.º	
2700K	670lm	20°	19	<b>1005867</b>	
	670lm	40°	19	<b>1005870</b>	
	670lm	55°	22	<b>1005873</b>	
3000K	690lm	20°	19	<b>1005885</b>	
	690lm	40°	19	<b>1005888</b>	
	690lm	55°	22	<b>1005891</b>	
4000K	730lm	20°	19	<b>1005903</b>	
	730lm	40°	19	<b>1005906</b>	
	730lm	55°	22	<b>1005909</b>	
2700K	720lm	20°	19	<b>1005868</b>	
	720lm	40°	19	<b>1005871</b>	
	720lm	55°	22	<b>1005874</b>	
3000K	730lm	20°	19	<b>1005886</b>	
	730lm	40°	19	<b>1005889</b>	
	730lm	55°	22	<b>1005892</b>	
4000K	790lm	20°	19	<b>1005904</b>	
	790lm	40°	19	<b>1005907</b>	
	790lm	55°	22	<b>1005910</b>	
2700K	690lm	20°	19	<b>1005869</b>	
	690lm	40°	19	<b>1005872</b>	
	690lm	55°	22	<b>1005875</b>	
3000K	700lm	20°	19	<b>1005887</b>	
	700lm	40°	19	<b>1005890</b>	
	700lm	55°	22	<b>1005893</b>	
4000K	750lm	20°	19	<b>1005905</b>	
	750lm	40°	19	<b>1005908</b>	
	750lm	55°	22	<b>1005911</b>	
2700K	670lm	20°	19	<b>1005876</b>	
	670lm	40°	19	<b>1005879</b>	
	670lm	55°	22	<b>1005882</b>	
3000K	690lm	20°	19	<b>1005894</b>	
	690lm	40°	19	<b>1005897</b>	
	690lm	55°	22	<b>1005900</b>	
4000K	730lm	20°	19	<b>1005912</b>	
	730lm	40°	19	<b>1005915</b>	
	730lm	55°	22	<b>1005918</b>	
2700K	720lm	20°	19	<b>1005877</b>	
	720lm	40°	19	<b>1005880</b>	
	720lm	55°	22	<b>1005883</b>	
3000K	730lm	20°	19	<b>1005895</b>	
	730lm	40°	19	<b>1005898</b>	
	730lm	55°	22	<b>1005901</b>	
4000K	790lm	20°	19	<b>1005913</b>	
	790lm	40°	19	<b>1005916</b>	
	790lm	55°	22	<b>1005919</b>	
2700K	690lm	20°	19	<b>1005878</b>	
	690lm	40°	19	<b>1005881</b>	
	690lm	55°	22	<b>1005884</b>	
3000K	700lm	20°	19	<b>1005896</b>	
	700lm	40°	19	<b>1005899</b>	
	700lm	55°	22	<b>1005902</b>	
4000K	750lm	20°	19	<b>1005914</b>	
	750lm	40°	19	<b>1005917</b>	
	750lm	55°	22	<b>1005920</b>	

# NUMINOS® GIMBLE M DL



● Preto

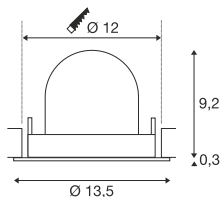

500mA

Consumo de energia: 17,5W

Material: alumínio/policarbonato (PC)

- Espessura do material da superfície a instalar: máx. 25mm.
- Conector de tensão reduzida
- Driver não incluído

Versão	EUR
Todas as versões M	112,00

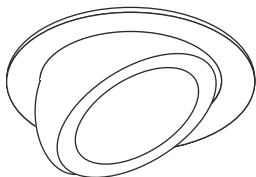

○ Branco



● Preto



○ Branco

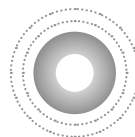

● Cromado



● Preto





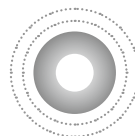





○ Branco



● Cromado

**Nota:**  
Encontra o driver, os difusores e anéis redutores adequados nas páginas 98-101.



			UGR	Art. N.º	
2700K	1460lm	20°	22	<b>1005921</b>	
	1460lm	40°	22	<b>1005924</b>	
	1460lm	55°	22	<b>1005927</b>	
3000K	1500lm	20°	22	<b>1005939</b>	
	1500lm	40°	22	<b>1005942</b>	
	1500lm	55°	22	<b>1005945</b>	
4000K	1600lm	20°	22	<b>1005957</b>	
	1600lm	40°	22	<b>1005960</b>	
	1600lm	55°	22	<b>1005963</b>	
2700K	1600lm	20°	22	<b>1005922</b>	
	1600lm	40°	22	<b>1005925</b>	
	1600lm	55°	22	<b>1005928</b>	
3000K	1600lm	20°	22	<b>1005940</b>	
	1600lm	40°	22	<b>1005943</b>	
	1600lm	55°	22	<b>1005946</b>	
4000K	1750lm	20°	22	<b>1005958</b>	
	1750lm	40°	22	<b>1005961</b>	
	1750lm	55°	22	<b>1005964</b>	
2700K	1550lm	20°	22	<b>1005923</b>	
	1550lm	40°	22	<b>1005926</b>	
	1550lm	55°	22	<b>1005929</b>	
3000K	1550lm	20°	22	<b>1005941</b>	
	1550lm	40°	22	<b>1005944</b>	
	1550lm	55°	22	<b>1005947</b>	
4000K	1660lm	20°	22	<b>1005959</b>	
	1660lm	40°	22	<b>1005962</b>	
	1660lm	55°	22	<b>1005965</b>	
2700K	1460lm	20°	22	<b>1005930</b>	
	1460lm	40°	22	<b>1005933</b>	
	1460lm	55°	22	<b>1005936</b>	
3000K	1500lm	20°	22	<b>1005948</b>	
	1500lm	40°	22	<b>1005951</b>	
	1500lm	55°	22	<b>1005954</b>	
4000K	1600lm	20°	22	<b>1005966</b>	
	1600lm	40°	22	<b>1005969</b>	
	1600lm	55°	22	<b>1005972</b>	
2700K	1600lm	20°	22	<b>1005931</b>	
	1600lm	40°	22	<b>1005934</b>	
	1600lm	55°	22	<b>1005937</b>	
3000K	1600lm	20°	22	<b>1005949</b>	
	1600lm	40°	22	<b>1005952</b>	
	1600lm	55°	22	<b>1005955</b>	
4000K	1750lm	20°	22	<b>1005967</b>	
	1750lm	40°	22	<b>1005970</b>	
	1750lm	55°	22	<b>1005973</b>	
2700K	1550lm	20°	22	<b>1005932</b>	
	1550lm	40°	22	<b>1005935</b>	
	1550lm	55°	22	<b>1005938</b>	
3000K	1550lm	20°	22	<b>1005950</b>	
	1550lm	40°	22	<b>1005953</b>	
	1550lm	55°	22	<b>1005956</b>	
4000K	1660lm	20°	22	<b>1005968</b>	
	1660lm	40°	22	<b>1005971</b>	
	1660lm	55°	22	<b>1005974</b>	

NUMINOS® GIMBLE L  
DL



● Preto

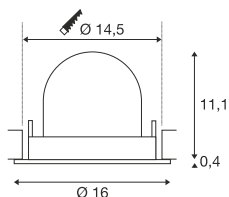

700mA  
Consumo de energia: 25,4W  
Material: alumínio/policarbonato (PC)

- Espessura do material da superfície a instalar: máx. 25 mm.
- Conector de tensão reduzida
- Driver não incluído

Versão	EUR
Todas as versões L	132,00

**Nota:**  
Encontra o driver, os difusores e anéis redutores adequados nas páginas 98-101.



● Preto



○ Branco

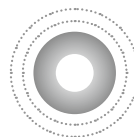

● Cromado



● Preto



○ Branco

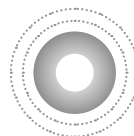



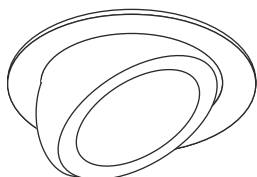





● Cromado



○ Branco



			UGR	Art. N.º	
2700K	2150lm	20°	22	<b>1005975</b>	
	2150lm	40°	22	<b>1005978</b>	
	2150lm	55°	22	<b>1005981</b>	
3000K	2150lm	20°	22	<b>1005993</b>	
	2150lm	40°	22	<b>1005996</b>	
	2150lm	55°	22	<b>1005999</b>	
4000K	2350lm	20°	22	<b>1006011</b>	
	2350lm	40°	22	<b>1006014</b>	
	2350lm	55°	22	<b>1006017</b>	
2700K	2250lm	20°	22	<b>1005976</b>	
	2250lm	40°	22	<b>1005979</b>	
	2250lm	55°	22	<b>1005982</b>	
3000K	2300lm	20°	22	<b>1005994</b>	
	2300lm	40°	22	<b>1005997</b>	
	2300lm	55°	22	<b>1006000</b>	
4000K	2450lm	20°	22	<b>1006012</b>	
	2450lm	40°	22	<b>1006015</b>	
	2450lm	55°	22	<b>1006018</b>	
2700K	2150lm	20°	22	<b>1005977</b>	
	2150lm	40°	22	<b>1005980</b>	
	2150lm	55°	22	<b>1005983</b>	
3000K	2200lm	20°	22	<b>1005995</b>	
	2200lm	40°	22	<b>1005998</b>	
	2200lm	55°	22	<b>1006001</b>	
4000K	2350lm	20°	22	<b>1006013</b>	
	2350lm	40°	22	<b>1006016</b>	
	2350lm	55°	22	<b>1006019</b>	
2700K	2150lm	20°	22	<b>1005984</b>	
	2150lm	40°	22	<b>1005987</b>	
	2150lm	55°	22	<b>1005990</b>	
3000K	2150lm	20°	22	<b>1006002</b>	
	2150lm	40°	22	<b>1006005</b>	
	2150lm	55°	22	<b>1006008</b>	
4000K	2350lm	20°	22	<b>1006020</b>	
	2350lm	40°	22	<b>1006023</b>	
	2350lm	55°	22	<b>1006026</b>	
2700K	2250lm	20°	22	<b>1005985</b>	
	2250lm	40°	22	<b>1005988</b>	
	2250lm	55°	22	<b>1005991</b>	
3000K	2300lm	20°	22	<b>1006003</b>	
	2300lm	40°	22	<b>1006006</b>	
	2300lm	55°	22	<b>1006009</b>	
4000K	2450lm	20°	22	<b>1006021</b>	
	2450lm	40°	22	<b>1006024</b>	
	2450lm	55°	22	<b>1006027</b>	
2700K	2150lm	20°	22	<b>1005986</b>	
	2150lm	40°	22	<b>1005989</b>	
	2150lm	55°	22	<b>1005992</b>	
3000K	2200lm	20°	22	<b>1006004</b>	
	2200lm	40°	22	<b>1006007</b>	
	2200lm	55°	22	<b>1006010</b>	
4000K	2350lm	20°	22	<b>1006022</b>	
	2350lm	40°	22	<b>1006025</b>	
	2350lm	55°	22	<b>1006028</b>	

NUMINOS® GIMBLE XL  
DL



● Preto

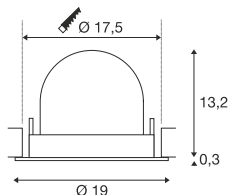

1050mA  
Consumo de energia: 37,4W  
Material: alumínio/policarbonato (PC)

- Espessura do material da superfície a instalar: máx. 25 mm.
- Conector de tensão reduzida
- Driver não incluído

Versão	EUR
Todas as versões XL	155,00



● Preto



○ Branco



● Cromado



● Preto

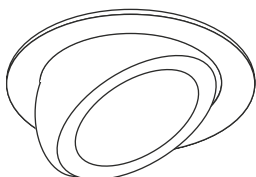

○ Branco



○ Branco

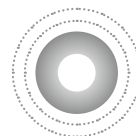









● Cromado

**Nota:**  
Encontra o driver, os difusores e anéis redutores adequados nas páginas 98-101.















			UGR	Art. N.º	
2700K	3300lm	20°	22	<b>1006029</b>	
	3300lm	40°	22	<b>1006032</b>	
	3300lm	55°	22	<b>1006035</b>	
3000K	3300lm	20°	22	<b>1006047</b>	
	3300lm	40°	22	<b>1006050</b>	
	3300lm	55°	22	<b>1006053</b>	
4000K	3600lm	20°	22	<b>1006065</b>	
	3600lm	40°	22	<b>1006068</b>	
	3600lm	55°	22	<b>1006071</b>	
2700K	3500lm	20°	22	<b>1006030</b>	
	3500lm	40°	22	<b>1006033</b>	
	3500lm	55°	22	<b>1006036</b>	
3000K	3550lm	20°	22	<b>1006048</b>	
	3550lm	40°	22	<b>1006051</b>	
	3550lm	55°	22	<b>1006054</b>	
4000K	3800lm	20°	22	<b>1006066</b>	
	3800lm	40°	22	<b>1006069</b>	
	3800lm	55°	22	<b>1006072</b>	
2700K	3400lm	20°	22	<b>1006031</b>	
	3400lm	40°	22	<b>1006034</b>	
	3400lm	55°	22	<b>1006037</b>	
3000K	3500lm	20°	22	<b>1006049</b>	
	3500lm	40°	22	<b>1006052</b>	
	3500lm	55°	22	<b>1006055</b>	
4000K	3750lm	20°	22	<b>1006067</b>	
	3750lm	40°	22	<b>1006070</b>	
	3750lm	55°	22	<b>1006073</b>	
2700K	3300lm	20°	22	<b>1006038</b>	
	3300lm	40°	22	<b>1006041</b>	
	3300lm	55°	22	<b>1006044</b>	
3000K	3300lm	20°	22	<b>1006056</b>	
	3300lm	40°	22	<b>1006059</b>	
	3300lm	55°	22	<b>1006062</b>	
4000K	3600lm	20°	22	<b>1006074</b>	
	3600lm	40°	22	<b>1006077</b>	
	3600lm	55°	22	<b>1006080</b>	
2700K	3500lm	20°	22	<b>1006039</b>	
	3500lm	40°	22	<b>1006042</b>	
	3500lm	55°	22	<b>1006045</b>	
3000K	3550lm	20°	22	<b>1006057</b>	
	3550lm	40°	22	<b>1006060</b>	
	3550lm	55°	22	<b>1006063</b>	
4000K	3800lm	20°	22	<b>1006075</b>	
	3800lm	40°	22	<b>1006078</b>	
	3800lm	55°	22	<b>1006081</b>	
2700K	3400lm	20°	22	<b>1006040</b>	
	3400lm	40°	22	<b>1006043</b>	
	3400lm	55°	22	<b>1006046</b>	
3000K	3500lm	20°	22	<b>1006058</b>	
	3500lm	40°	22	<b>1006061</b>	
	3500lm	55°	22	<b>1006064</b>	
4000K	3750lm	20°	22	<b>1006076</b>	
	3750lm	40°	22	<b>1006079</b>	
	3750lm	55°	22	<b>1006082</b>	

## ACESSÓRIOS

Atribuição de drivers e módulos

						
LED driver 10W   200mA	LED driver 10W   200mA regulável	LED driver 13,5W   200mA regulável via DALI	LED driver 12W   200mA DALI para módulo RF	Módulo RF Zigbee	Módulo RF Casambi	
<b>XS</b>						
						
200mA						
<b>Material</b>	Policarbonato (PC)			Policarbonato (PC)		
<b>Cor</b>	Branco			Branco		
<b>Tensão primário</b>	200-240V ~50/60Hz			3.3V		
<b>Tensão secundário</b>	29-42V DC	30-42V DC	15-54V DC	10-40V DC	-	
<b>Corrente de saída</b>	200mA			-		
<b>Número de saídas sec.</b>	1			-		
<b>Potência de</b>	5.8W	6W	3.8W	1.5W	-	
<b>Potência até</b>	8.4W		13.5W	12W	-	
<b>Temp. ambiente mín.</b>	-20°C			-40°C		
<b>Temp. ambiente máx.</b>	50°C			45°C		
<b>Proteção térmica</b>	110°C			-		
<b>Classe de proteção IP</b>	IP 20			-		
<b>Regulável</b>	-	PHASE C	DALI	DALI para RF	Zigbee	Casambi
<b>Comprimento</b>	6.5 cm	8.5 cm	18 cm	14.18 cm	4.3 cm	
<b>Largura</b>	3.9 cm	4.1 cm	4.5 cm	4.38 cm	3.1 cm	
<b>Altura</b>	2 cm	2.2 cm	2.7 cm	3 cm	1.2 cm	
<b>Art. N.º</b>	<b>1005610</b>	<b>1005609</b>	<b>1005611</b>	<b>1006457</b>	<b>1006199</b>	<b>1006454</b>
<b>EUR</b>	<b>26,00</b>	<b>35,75</b>	<b>96,00</b>	<b>90,00</b>	<b>38,00</b>	<b>129,00</b>

## Difusores

				
Difusor elíptico	Difusor prismático	Difusor fosco	Difusor Alveolar	
<b>XS</b>				
<b>Art. N.º</b>	<b>1005612</b>	<b>1005613</b>	<b>1005614</b>	<b>1005615</b>
<b>EUR</b>	<b>4,50</b>	<b>5,30</b>	<b>5,30</b>	<b>8,35</b>



LED driver 10W   250mA	LED driver 10W   250mA regulável	LED driver 20W   250mA regulável via DALI	LED driver 12W   250mA DALI para módulo RF	Módulo RF Zigbee	Módulo RF Casambi
<b>S</b>					
250mA		250/350/500/700mA	250mA		
Material				Policarbonato (PC)	
Cor				Branco	
Tensão primário				220-240V ~50/60Hz	
Tensão secundário		26-40V DC	6-60V DC	10-40V DC	
Corrente de saída				250mA	
Número de saídas sec.				1	
Potência de		6.5W	1.5W		
Potência até		10W	20W	12W	
Temp. ambiente mín.				-20°C	
Temp. ambiente máx.		45°C	50°C	45°C	
Proteção térmica				110°C	
Classe de proteção IP				IP 20	
Regulável	-	PHASE C	DALI	DALI para RF	Zigbee Casambi
Comprimento	6.5 cm	6.5 cm	15 cm	14.18 cm	4.3 cm
Largura	3.9 cm	3.9 cm	5.2 cm	4.38 cm	3.1 cm
Altura	2 cm	2 cm	2.8 cm	3 cm	1.2 cm
Art. N.º	1004058	1004055	1004067	1006458	1006199 1006454
EUR	26,00	40,75	82,00	90,00	38,00 129,00

Difusor elíptico	Difusor prismático	Difusor fosco	Difusor Alveolar

**S**





Art. N.º	1004786	1004787	1004788	1004789
EUR	4,50	5,30	5,30	8,35

## ACESSÓRIOS



Atribuição de controladores e módulos

						
	LED driver 30W   500mA	LED driver 30W   500mA regulável	LED driver 40W   500mA DALI regulável	LED driver 42W   500mA DALI para módulo RF	Módulo RF Zigbee	Módulo RF Casambi
	<b>M</b>					
						
	500/600/700mA	500mA	250/350/500/700mA	500mA		
<b>Material</b>	Policarbonato (PC)				Policarbonato (PC)	
<b>Cor</b>	Branco				Branco	
<b>Tensão primário</b>	220-240V ~50/60Hz				3.3V	
<b>Tensão secundário</b>	30-42V DC	25-42V DC	6 - 58V DC	10-42V DC		
<b>Corrente de saída</b>	500mA					
<b>Número de saídas sec.</b>	1					
<b>Potência de</b>	21W	12.5W	1.5W	5W		
<b>Potência até</b>	29.5W	21W	40.6W	42W		
<b>Temp. ambiente mín.</b>	-20°C		-25°C	-20°C	-40°C	
<b>Temp. ambiente máx.</b>	50°C			45°C	45°C	
<b>Proteção térmica</b>	110°C					
<b>Classe de proteção IP</b>	IP 20					
<b>Regulável</b>	-	PHASE C	DALI	DALI para RF	Zigbee	Casambi
<b>Comprimento</b>	14.7 cm	11.5 cm	12.3 cm	12.3 cm	4.3 cm	
<b>Largura</b>	4.3 cm	4.1 cm	7.9 cm	7.9 cm	3.1 cm	
<b>Altura</b>	3 cm	2.5 cm	2.4 cm	3 cm	1.2 cm	
<b>Art. N.º</b>	<b>1004064</b>	<b>1004054</b>	<b>1004069</b>	<b>1006459</b>	<b>1006199</b>	<b>1006454</b>
<b>EUR</b>	<b>30,75</b>	<b>59,00</b>	<b>82,00</b>	<b>105,00</b>	<b>38,00</b>	<b>129,00</b>

## Difusores

				
	Difusor elíptico	Difusor prismático	Difusor fosco	Difusor Alveolar
	<b>M</b>			
<b>Art. N.º</b>	<b>1004790</b>	<b>1004791</b>	<b>1004792</b>	<b>1004793</b>
<b>EUR</b>	<b>4,50</b>	<b>5,80</b>	<b>5,80</b>	<b>12,60</b>

						
LED driver 30W   700mA	LED driver 30W   700mA regulável	LED driver 40W   700mA DALI regulável	LED driver 42W   700mA DALI para módulo RF	Módulo RF Zigbee	Módulo RF Casambi	
						
						
500/600/700mA		700mA				
<b>Material</b>	Policarbonato (PC)			Policarbonato (PC)		
<b>Cor</b>	Branco			Branco		
<b>Tensão prim.</b>	220-240V ~50/60Hz			3.3V		
<b>Tensão sec.</b>	30-42V DC	25-42V DC	6-58V DC	10-42V DC	-	
<b>Corrente de saída</b>	700mA		250/350/500/700mA	700mA	-	
<b>Número de saídas sec.</b>	1					
<b>Potência de</b>	21W	17.5W	1.5W	5W	-	
<b>Potência até</b>	29.5W	29.4W	40.6W	42W	-	
<b>Temp. ambiente mín.</b>	-20°C		-25°C	-20°C	-40°C	
<b>Temp. ambiente máx.</b>	50°C			45°C	45°C	
<b>Proteção térmica</b>	110°C					
<b>Classe de proteção IP</b>	IP 20					
<b>Regulável</b>	-	PHASE C	DALI	DALI para RF	Zigbee	Casambi
<b>Comprimento</b>	14.7 cm	14.5 cm	12.3 cm	12.3 cm	4.3 cm	
<b>Largura</b>	4.3 cm	4 cm	7.9 cm	7.9 cm	3.1 cm	
<b>Altura</b>	3 cm	3 cm	2.4 cm	3 cm	1.2 cm	
<b>Art. N.º</b>	1004062	1004065	1004070	1006460	1006199	1006454
<b>EUR</b>	32,00	59,00	82,00	105,00	38,00	129,00

			
Difusor elíptico	Difusor prismático	Difusor fosco	Difusor Alveolar



<b>Art. N.º</b>	1004794	1004795	1004796	1004797
<b>EUR</b>	5,80	6,45	6,45	16,40

## ACESSÓRIOS

Atribuição de controladores e módulos

	LED driver 40W   1050mA	LED driver 40W   1000mA regulável	LED driver 50W   1050mA DALI regulável	LED driver 40W   1050mA DALI para módulo RF	Módulo RF Zigbee	Módulo RF Casambi
	<b>XL</b>					
	800/900/1050mA	1000mA	1050mA	1050mA		
<b>Material</b>	Policarbonato (PC)				Policarbonato (PC)	
<b>Cor</b>	Branco				Branco	
<b>Tensão primário</b>	220-240V ~50/60Hz				3.3V	
<b>Tensão secundário</b>	25-42V DC	25-40V DC	6-58V DC	10-42V DC		
<b>Corrente de saída</b>	1050mA	1000mA	1050mA			
<b>Número de saídas sec.</b>	1					
<b>Potência de</b>	20W	26.3W	4.2W	5W		
<b>Potência até</b>	44W	42W	50W	42W		
<b>Temp. ambiente mín.</b>	-20°C		-25°C	-20°C	-40°C	
<b>Temp. ambiente máx.</b>	50°C	45°C	50°C	45°C	45°C	
<b>Proteção térmica</b>	110°C					
<b>Classe de proteção IP</b>	IP 20					
<b>Regulável</b>	-	PHASE C	DALI	DALI para RF	Zigbee	Casambi
<b>Comprimento</b>	14.7 cm	14.5 cm	12.3 cm	12.3 cm	4.3 cm	
<b>Largura</b>	4.3 cm	4 cm	7.9 cm	7.9 cm	3.1 cm	
<b>Altura</b>	3 cm	3 cm	2.4 cm	3 cm	1.2 cm	
<b>Art. N.º</b>	<b>1004059</b>	<b>1004066</b>	<b>1004071</b>	<b>1006461</b>	<b>1006199</b>	<b>1006454</b>
<b>EUR</b>	<b>34,00</b>	<b>63,00</b>	<b>82,00</b>	<b>105,00</b>	<b>38,00</b>	<b>129,00</b>

## Difusores

Difusor elíptico	Difusor prismático	Difusor fosco	Difusor Alveolar

**XL**

<b>Art. N.º</b>	<b>1004798</b>	<b>1004799</b>	<b>1004800</b>	<b>1004801</b>
<b>EUR</b>	<b>6,45</b>	<b>7,10</b>	<b>7,10</b>	<b>21,50</b>

## Anel redutor redondo

<b>Material</b>	Aço	Aço	Aço	Aço	Aço
<b>Ø exterior</b>	16 cm	16 cm	24 cm	24 cm	24 cm
<b>Altura</b>	5,3 cm	5,3 cm	5,3 cm	5,3 cm	5,3 cm
<b>Ø interior</b>	7 cm	10 cm	12 cm	15 cm	18 cm
<b>Recorte do teto</b>	8,5 - 13 cm	12 - 15 cm	14 - 18 cm	17 - 20 cm	20 - 22 cm
<b>Espessura do material</b>	3 cm	3 cm	3 cm	3 cm	3 cm
<b>Art. N.º preto</b>	<b>1006135</b>	<b>1006139</b>	<b>1006143</b>	<b>1006147</b>	<b>1006151</b>
<b>Art. N.º branco</b>	<b>1006136</b>	<b>1006140</b>	<b>1006144</b>	<b>1006148</b>	<b>1006152</b>
<b>EUR</b>	<b>18,00</b>	<b>15,50</b>	<b>19,20</b>	<b>18,00</b>	<b>16,70</b>

## Anel redutor quadrado

<b>Material</b>	Aço	Aço	Aço	Aço	Aço
<b>Comprimento</b>	16 cm	16 cm	24 cm	24 cm	24 cm
<b>Largura</b>	16 cm	16 cm	24 cm	24 cm	24 cm
<b>Altura</b>	5,3 cm	5,3 cm	5,3 cm	5,3 cm	5,3 cm
<b>Ø interior</b>	7 cm	10 cm	12 cm	15 cm	18 cm
<b>Recorte do teto</b>	8,5 - 13 cm	12 - 15 cm	14 - 18 cm	17 - 20 cm	20 - 22 cm
<b>Espessura do material</b>	3 cm	3 cm	3 cm	3 cm	3 cm
<b>Art. N.º preto</b>	<b>1006137</b>	<b>1006141</b>	<b>1006145</b>	<b>1006149</b>	<b>1006153</b>
<b>Art. N.º branco</b>	<b>1006138</b>	<b>1006142</b>	<b>1006146</b>	<b>1006150</b>	<b>1006154</b>
<b>EUR</b>	<b>18,00</b>	<b>15,50</b>	<b>19,20</b>	<b>18,00</b>	<b>16,70</b>

NEW TRIA® 68  
DL, PHASE



1



● Preto



○ Branco

2



● Preto



○ Branco

1

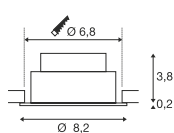

2

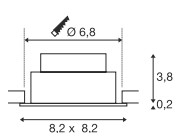

220-240V ~50/60Hz | 200mA  
Potência do sistema: 8,3W  
Material: alumínio

- Espessura do material da superfície a instalar: máx. 20 mm







Art. N.º

EUR

30°	IP 20	2700K	705lm	38°	<b>1007386</b>	<b>54,00</b>	
		2700K	705lm	60°	<b>1007388</b>	<b>54,00</b>	
		3000K	750lm	38°	<b>1007390</b>	<b>54,00</b>	
		3000K	750lm	60°	<b>1007392</b>	<b>54,00</b>	
30°	IP 20	2700K	705lm	38°	<b>1007385</b>	<b>54,00</b>	
		2700K	705lm	60°	<b>1007387</b>	<b>54,00</b>	
		3000K	750lm	38°	<b>1007389</b>	<b>54,00</b>	
		3000K	750lm	60°	<b>1007391</b>	<b>54,00</b>	
30°	IP 20	2700K	705lm	38°	<b>1007394</b>	<b>54,00</b>	
		2700K	705lm	60°	<b>1007396</b>	<b>54,00</b>	
		3000K	750lm	38°	<b>1007398</b>	<b>54,00</b>	
		3000K	750lm	60°	<b>1007400</b>	<b>54,00</b>	
30°	IP 20	2700K	705lm	38°	<b>1007393</b>	<b>54,00</b>	
		2700K	705lm	60°	<b>1007395</b>	<b>54,00</b>	
		3000K	750lm	38°	<b>1007397</b>	<b>54,00</b>	
		3000K	750lm	60°	<b>1007399</b>	<b>54,00</b>	

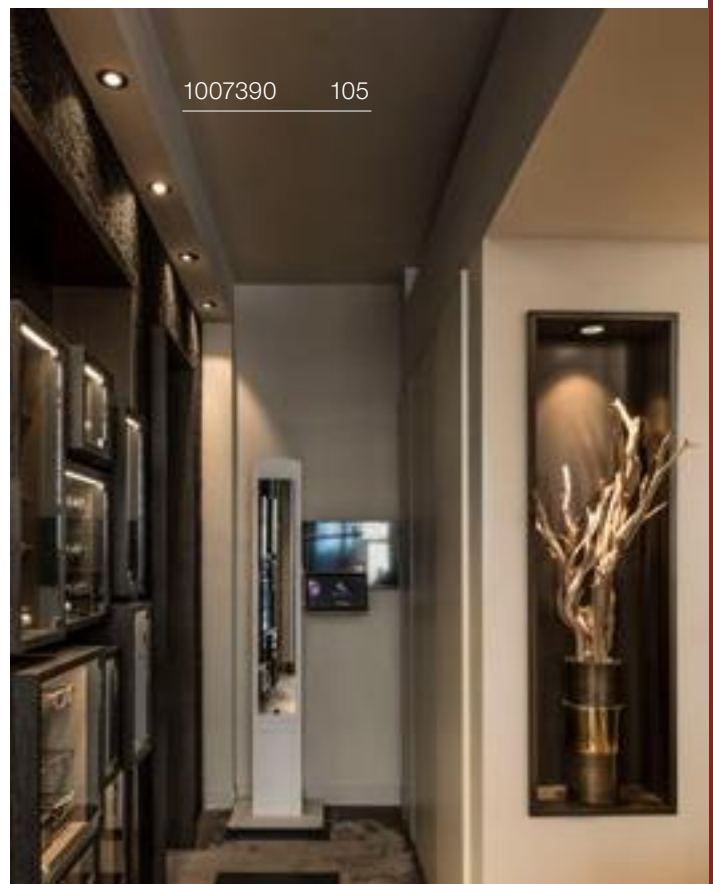

## NEW TRIA® 68 DL, PHASE

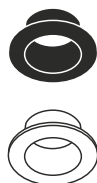
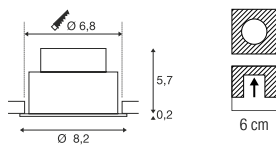

● Preto

○ Branco



220-240V ~50/60Hz | 200mA  
Potência do sistema: 8,3W  
Material: alumínio

- Espessura do material da superfície a instalar: máx. 20 mm

## NEW TRIA® 75 DL, Redondo, PHASE

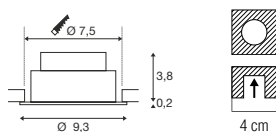

● Preto

○ Branco





220-240V ~50/60Hz | 200mA  
Potência do sistema: 8,3W  
Material: alumínio

- Espessura do material da superfície a instalar: máx. 20 mm



Art. N.º

EUR



-	IP 20 IP 65*	2700K	460lm	38°	<b>1007406</b>	<b>69,00</b>	
		3000K	500lm	38°	<b>1007408</b>	<b>69,00</b>	
-	IP 20 IP 65*	2700K	530lm	38°	<b>1007405</b>	<b>69,00</b>	
		3000K	570lm	38°	<b>1007407</b>	<b>69,00</b>	

\*IP65 no lado do compartimento



Art. N.º

EUR

30°	IP 20	2700K	705lm	38°	<b>1007402</b>	<b>64,00</b>	
		3000K	750lm	38°	<b>1007404</b>	<b>64,00</b>	
30°	IP 20	2700K	705lm	38°	<b>1007401</b>	<b>64,00</b>	
		3000K	750lm	38°	<b>1007403</b>	<b>64,00</b>	



NEW TRIA® 68  
DL, DTW, PHASE



1



● Preto



○ Branco

2



● Preto



○ Branco

1

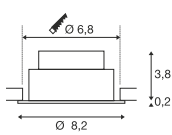

2

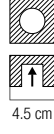
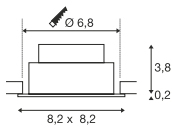

220-240V ~50/60Hz | 250mA  
Potência do sistema: 11W  
Material: alumínio

- Espessura do material da superfície a instalar: máx. 20 mm





Art. N.º

EUR

30°	IP 20	1800K - 3000K	70lm - 700lm	38°	<b>1007424</b>	<b>69,00</b>		
				60°	<b>1007426</b>	<b>69,00</b>		
30°	IP 20	1800K - 3000K	70lm - 700lm	38°	<b>1007423</b>	<b>69,00</b>		
				60°	<b>1007425</b>	<b>69,00</b>		
30°	IP 20	1800K - 3000K	70lm - 700lm	38°	<b>1007428</b>	<b>69,00</b>		
				60°	<b>1007430</b>	<b>69,00</b>		
30°	IP 20	1800K - 3000K	70lm - 700lm	38°	<b>1007427</b>	<b>69,00</b>		
				60°	<b>1007429</b>	<b>69,00</b>		

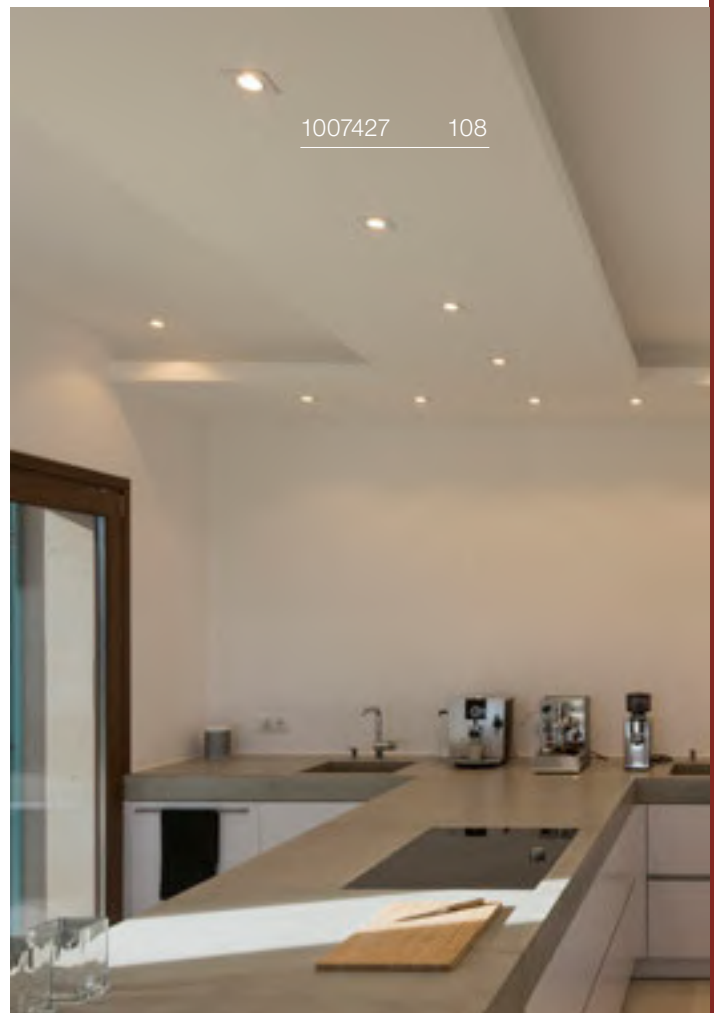

# NEW TRIA® UNIVERSAL 68 DL, PHASE



1

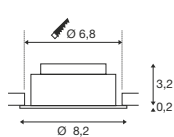

2

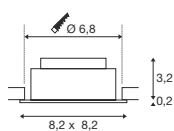

3

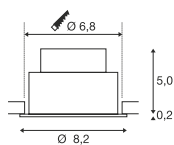

220-240V ~50/60Hz | 100-180mA  
Potência do sistema: 8,6W  
Material: alumínio

- Espessura do material da superfície a instalar: máx. 20 mm

1



● Preto

2



○ Branco



● Preto



○ Branco

3













● Preto



○ Branco





						Art. N.º	EUR	
30°	IP 20	2500K 3000K 4000K	540lm 600lm 600lm	38°	<b>1007434</b>	<b>89,00</b>		
				60°	<b>1007436</b>	<b>89,00</b>		
30°	IP 20	2500K 3000K 4000K	540lm 600lm 600lm	38°	<b>1007433</b>	<b>89,00</b>		
				60°	<b>1007435</b>	<b>89,00</b>		
30°	IP 20	2500K 3000K 4000K	540lm 600lm 600lm	38°	<b>1007438</b>	<b>89,00</b>		
				60°	<b>1007440</b>	<b>89,00</b>		
30°	IP 20	2500K 3000K 4000K	540lm 600lm 600lm	38°	<b>1007437</b>	<b>89,00</b>		
				60°	<b>1007439</b>	<b>89,00</b>		
-	IP 20 IP 65*	2500K 3000K 4000K	370lm 410lm 410lm	38°	<b>1007442</b>	<b>99,00</b>		
-	IP 20 IP 65*	2500K 3000K 4000K	370lm 410lm 410lm	38°	<b>1007441</b>	<b>99,00</b>		

\*IP65 no lado do compartimento

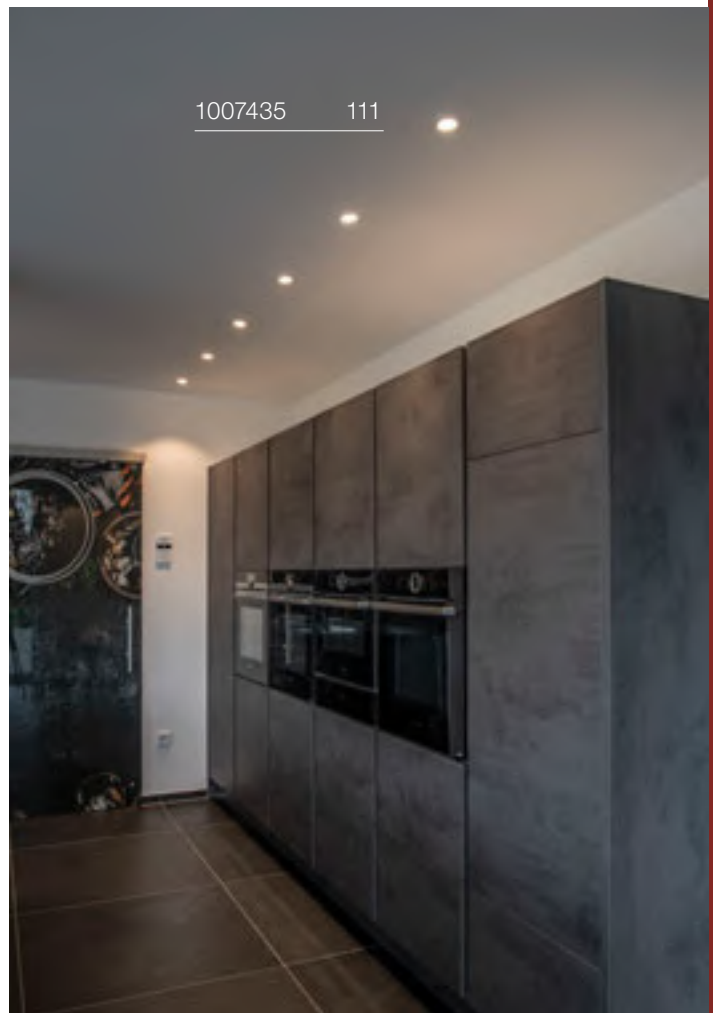

NEW TRIA® 68  
DL, QPAR51



1



2



● Preto

○ Branco

● Alumínio

● Preto

○ Branco

● Alumínio

1

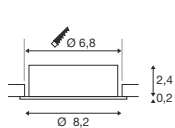

2

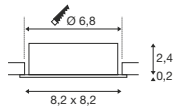

220-240V ~50/60Hz  
Material: alumínio

- Espessura do material da superfície a instalar: máx. 20 mm



LED GU10 51 mm | 6W | 36°  
2200-2700K | 360lm | CEE=G  
6kWh/1000h



Art. N.º: 1005273 | 9,99 EUR







Art. N.º

EUR

30°

IP 20

Casquilho: 1xGU10

-

1007369

19,90



30°

IP 20

Casquilho: 1xGU10

-

1007368

19,90



30°

IP 20

Casquilho: 1xGU10

-

1007370

25,90



30°

IP 20

Casquilho: 1xGU10

-

1007372

19,90



30°

IP 20

Casquilho: 1xGU10

-

1007371

19,90



30°

IP 20

Casquilho: 1xGU10

-

1007373

25,90



1007369 113



NEW TRIA® 75 / XL  
DL, QPAR51



1

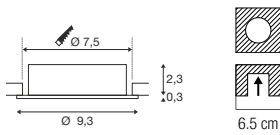

2

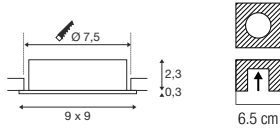

XL

3

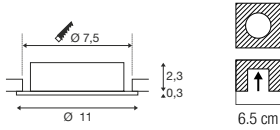

4

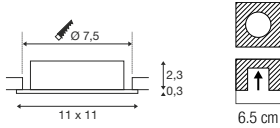

1



● Preto



○ Branco



● Alumínio

2



● Preto



○ Branco



● Alumínio

3



● Preto, XL



○ Branco, XL



● Alumínio, XL

4



● Preto, XL



○ Branco, XL



● Alumínio, XL



220-240V ~50/60Hz  
Material: alumínio

- Espessura do material da superfície a instalar: máx. 20 mm



LED GU10 51 mm | 6W | 36°  
2200-2700K | 360lm | CEE=G  
6kWh/1000h













Art. N.º: 1005273 | 9,99 EUR

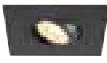

Art. N.º

EUR

30°	IP 20	Casquilho: 1xGU10	-	1007375	25,90	
30°	IP 20	Casquilho: 1xGU10	-	1007374	25,90	
30°	IP 20	Casquilho: 1xGU10	-	1007376	29,90	
30°	IP 20	Casquilho: 1xGU10	-	1007378	25,90	
30°	IP 20	Casquilho: 1xGU10	-	1007377	25,90	
30°	IP 20	Casquilho: 1xGU10	-	1007379	29,90	
30°	IP20	Casquilho: 1xGU10	-	1007625	30,90	
30°	IP20	Casquilho: 1xGU10	-	1007624	30,90	
30°	IP20	Casquilho: 1xGU10	-	1007626	34,90	
30°	IP20	Casquilho: 1xGU10	-	1007628	30,90	
30°	IP20	Casquilho: 1xGU10	-	1007627	30,90	
30°	IP20	Casquilho: 1xGU10	-	1007629	34,90	



NEW TRIA®  
155 DL, double, QPAR51



1008510 116

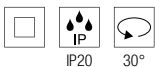
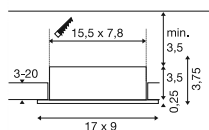

220-240V ~50/60Hz  
Material: alumínio

- Espessura do material da superfície a instalar: máx. 20 mm



Casquilho: 2xGU10

Versão	Art. n.º	EUR
● Preto	1008510	45,00
○ Branco	1008509	45,00



LED GU10 51 mm | 6W | 38°  
2700K | 450lm | CEE=F  
6kWh/1000h



Art. N.º: 1005077 | 7,50 EUR





1008512 117

**NEW TRIA®**  
155 DL, double

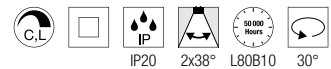
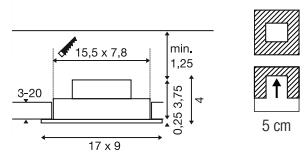

220-240V ~50/60Hz | 350mA  
Potência do sistema: 13,6W  
Material: alumínio

- Espessura do material da superfície a instalar: máx. 20 mm



Down

610lm | 2700K

Versão	Art. n.º	EUR
● Preto 610lm   2700K	<b>1008512</b>	<b>109,00</b>
● Preto 640lm   3000K	<b>1008514</b>	<b>109,00</b>
○ Branco 610lm   2700K	<b>1008511</b>	<b>109,00</b>
○ Branco 640lm   3000K	<b>1008513</b>	<b>109,00</b>

COMBINE OUTROS ARTIGOS  
DAS PÁGINAS SEGUINTE



Casquilho GU10 ou módulo LED



Aro de acabamento nas cores  
preto, branco, rosa dourado,  
alumínio



## GU10 LED CONNECTION BOX

com casquilho, máx. 10 W

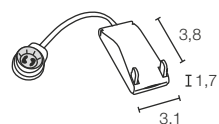

220-240V ~50/60Hz  
Material: plástico



Casquilho: 1xGU10

Versão	Art. n.º	EUR
● Preto	1007283	6,00

**NEW TRIA®**  
DL, Módulo LEDI, PHASE

**NEW TRIA®**  
DL, Módulo LED, DTW, PHASE

**NEW TRIA® UNIVERSAL**  
DL, Módulo LED, PHASE

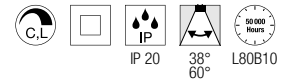
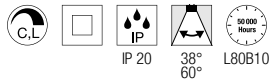
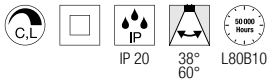
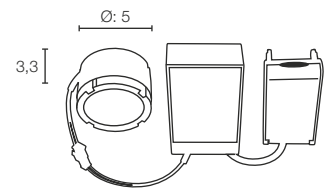
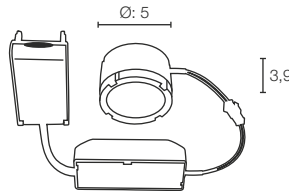
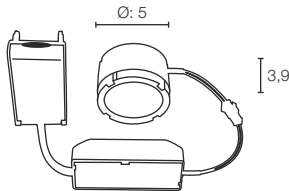
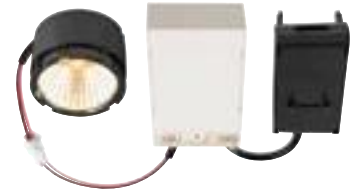

220-240V ~50/60 Hz | 200mA  
Potência do sistema: 8,63W  
Material: alumínio

220-240V ~50/60Hz | 250mA  
Potência do sistema: 11W  
Material: alumínio

220-240V ~50/60Hz | 100-180mA  
Potência do sistema: 8,6W  
Material: alumínio



Down 705 | 2700K  
750 | 3000K

Down 70lm | 1800K - 700lm | 3000K

540lm | 2500K | 600lm | 3000K | 600lm | 4000K

Versão	Art. n.º	EUR
● Preto 2700K   38°	1007381	45,00
● Preto 2700K   60°	1007382	45,00
● Preto 3000K   38°	1007383	45,00
● Preto 3000K   60°	1007384	45,00

Versão	Art. n.º	EUR
● Preto 38°	1007421	56,00
● Preto 60°	1007422	56,00

Versão	Art. n.º	EUR
● Preto 38°	1007431	76,00
● Preto 60°	1007432	76,00

1007381 + 1007334 119 + 120

## NEW TRIA® 68

Aro, redondo, GU10/módulo LED



A: 2,6 cm  
Ø: 8,2 cm  
Material: alumínio

- Diâmetro de encastramento: 68 mm
- Espessura do material da superfície a instalar: máx. 20 mm

Versão	Art. n.º	EUR
● Preto	1007332	14,90
○ Branco	1007333	14,90
● Alumínio	1007335	19,90
● ouro vermelho	1007334	24,90

## NEW TRIA® 68

Aro, quadrado, GU10/módulo LED



C: 8,2 cm  
L: 8,2 cm  
A: 2,6 cm  
Material: alumínio

- Diâmetro de encastramento: 68 mm
- Espessura do material da superfície a instalar: máx. 20 mm

Versão	Art. n.º	EUR
● Preto	1007329	14,90
○ Branco	1007328	14,90
● Alumínio	1007330	19,90
● ouro vermelho	1007331	24,90





**NEW TRIA® 68**  
Anel, redondo, GU10/módulo LED



A: 4,4 cm  
Ø: 8,2 cm  
Material: alumínio

- Diâmetro de encastramento: 68 mm
- Espessura do material da superfície a instalar: máx. 20 mm

Versão	Art. n.º	EUR
● Preto	<b>1007451</b>	<b>15,90</b>
○ Branco	<b>1007453</b>	<b>15,90</b>

**NEW TRIA® 68**  
Anel, redondo, GU10/módulo LED



A: 3,55 cm  
Ø: 8,3 cm  
Material: alumínio/vidro

- Diâmetro de encastramento: 68 mm
- Espessura do material da superfície a instalar: máx. 20 mm

Versão	Art. n.º	EUR
● Preto	<b>1007336</b>	<b>35,90</b>
○ Branco	<b>1007337</b>	<b>35,90</b>

**NEW TRIA® 68**  
Anel, quadrado, GU10/módulo LED



C: 8,3 cm  
L: 8,3 cm  
A: 3,55 cm  
Material: alumínio/vidro

- Diâmetro de encastramento: 68 mm
- Espessura do material da superfície a instalar: máx. 20 mm

Versão	Art. n.º	EUR
● Preto	<b>1007338</b>	<b>35,90</b>
○ Branco	<b>1007339</b>	<b>35,90</b>

**NEW TRIA® 68**  
Aro, redondo, GU10/módulo LED



A: 3,4 cm  
Ø: 8,2 cm  
Material: alumínio

- Diâmetro de encastramento: 68 mm
- Espessura do material da superfície a instalar: máx. 20 mm

Versão	Art. n.º	EUR
● Preto	<b>1007345</b>	<b>24,90</b>
○ Branco	<b>1007346</b>	<b>24,90</b>

**NEW TRIA® 68**  
Aro, quadrado, GU10/módulo LED



C: 8,2 cm  
L: 8,2 cm  
A: 3,4 cm  
Material: alumínio

- Diâmetro de encastramento: 68 mm
- Espessura do material da superfície a instalar: máx. 20 mm

Versão	Art. n.º	EUR
● Preto	<b>1007347</b>	<b>24,90</b>
○ Branco	<b>1007348</b>	<b>24,90</b>

**NEW TRIA® 75**  
Aro, redondo, GU10/módulo LED



A: 2,6 cm  
Ø: 9,3 cm  
Material: alumínio

- Diâmetro de encastramento: 75 mm
- Espessura do material da superfície a instalar: máx. 20 mm

Versão	Art. n.º	EUR
● Preto	1007343	19,90
○ Branco	1007342	19,90
● Alumínio	1007351	23,90
● ouro vermelho	1007344	28,90

**NEW TRIA® 75**  
Aro, quadrado, GU10/módulo LED

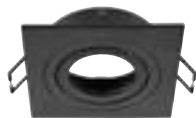

C: 9 cm  
L: 9 cm  
A: 2,6 cm  
Material: alumínio

- Diâmetro de encastramento: 75 mm
- Espessura do material da superfície a instalar: máx. 20 mm

Versão	Art. n.º	EUR
● Preto	1007340	19,90
○ Branco	1007349	19,90
● Alumínio	1007350	23,90
● ouro vermelho	1007341	28,90

**NEW TRIA® 75**  
Aro, redondo, GU10/módulo LED



A: 4,9 cm  
Ø: 8,2 cm  
Material: alumínio

- Diâmetro de encastramento: 75 mm
- Espessura do material da superfície a instalar: máx. 20 mm

Versão	Art. n.º	EUR
● Preto	1007449	18,90
○ Branco	1007450	18,90

**NEW TRIA® 75**  
Aro, redondo, GU10/módulo LED



A: 4,3 cm  
Ø: 8,2 cm  
Material: alumínio

- Diâmetro de encastramento: 75 mm
- Espessura do material da superfície a instalar: máx. 20 mm

Versão	Art. n.º	EUR
● Preto	1007488	14,90
○ Branco	1007489	14,90



**NEW TRIA® 75 XL**  
Aro, redondo, GU10/módulo LED



A: 2,6 cm  
Ø: 11 cm  
Material: alumínio

- Diâmetro de encastramento: 75 mm
- Espessura do material da superfície a instalar: máx. 20 mm

Versão	Art. n.º	EUR
● Preto	<b>1007631</b>	<b>24,90</b>
○ Branco	<b>1007630</b>	<b>24,90</b>
● Alumínio	<b>1007632</b>	<b>28,90</b>
● ouro vermelho	<b>1007633</b>	<b>33,90</b>

**NEW TRIA® 75 XL**  
Aro, redondo, GU10/módulo LED

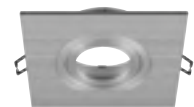

C: 11 cm  
L: 11 cm  
A: 2,6 cm  
Material: alumínio

- Diâmetro de encastramento: 75 mm
- Espessura do material da superfície a instalar: máx. 20 mm

Versão	Art. n.º	EUR
● Preto	<b>1007635</b>	<b>24,90</b>
○ Branco	<b>1007634</b>	<b>24,90</b>
● Alumínio	<b>1007636</b>	<b>28,90</b>
● ouro vermelho	<b>1007637</b>	<b>33,90</b>

1007283 + 1007342 118 + 122



## CRIE O SEU DOWNLIGHT NEW TRIA 95



Módulo LED



Anéis de montagem nas cores  
preto, branco, rosa dourado,  
alumínio



1007412 + 1007446 127





**NEW TRIA®**  
DL, Módulo LED, PHASE

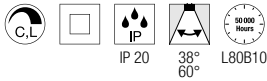
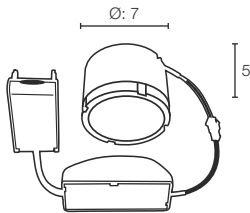

Material: alumínio

- Espessura do material da superfície a instalar: máx. 20 mm



Down 1130 | 2700K  
1200 | 3000K

Versão	Art. n.º	EUR
● Preto 1130lm   2700K   38°	<b>1007409</b>	<b>95,00</b>
● Preto 1200lm   3000K   38°	<b>1007410</b>	<b>95,00</b>
● Preto 1130lm   2700K   60°	<b>1007411</b>	<b>95,00</b>
● Preto 1200lm   3000K   60°	<b>1007412</b>	<b>95,00</b>

**NEW TRIA® 95**  
Aro, redondo, módulo LED



A: 2,6 cm  
Ø: 11 cm  
Material: alumínio

- Diâmetro de encastramento: 95 mm
- Espessura do material da superfície a instalar: máx. 20 mm

Versão	Art. n.º	EUR
● Preto	<b>1007444</b>	<b>29,90</b>
○ Branco	<b>1007443</b>	<b>29,90</b>
● Alumínio	<b>1007445</b>	<b>34,90</b>
● ouro vermelho	<b>1007447</b>	<b>39,90</b>

**NEW TRIA® 95**  
Aro, redondo, módulo LED



A: 5,5 cm  
Ø: 10,3 cm  
Material: alumínio

- Diâmetro de encastramento: 95 mm
- Espessura do material da superfície a instalar: máx. 20 mm

Versão	Art. n.º	EUR
● Preto	<b>1007452</b>	<b>29,90</b>
○ Branco	<b>1007454</b>	<b>29,90</b>

**NEW TRIA® 95**  
Aro, quadrado, módulo LED



C: 11 cm  
L: 11 cm  
A: 2,6 cm  
Material: alumínio

- Diâmetro de encastramento: 95 mm
- Espessura do material da superfície a instalar: máx. 20 mm

Versão	Art. n.º	EUR
● Preto	<b>1007446</b>	<b>29,90</b>
○ Branco	<b>1007448</b>	<b>29,90</b>





**NEW TRIA®**  
DL, double Módulo LED, PHASE

**NEW TRIA® 155**  
Ring, double, square  
GU10/módulo LED



C: 17 cm L: 9 cm A: 3,75 cm  
Material: alumínio

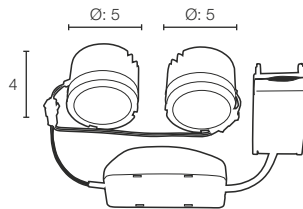

Versão	Art. n.º	EUR
● Preto	1008007	37,00
○ Branco	1008008	37,00
● Alumínio	1008009	37,00

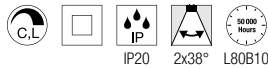

220-240V ~50/60Hz | 350mA  
Potência do sistema: 13,6W  
Material: alumínio



Down 610lm | 2700K

Versão	Art. n.º	EUR
● Preto 1220lm   2700K	1008005	75,00
● Preto 1280lm   3000K	1008006	75,00

# CONFIGURE O SEU NEW TRIA®

---

Para uma maior flexibilidade, o NEW TRIA oferece a possibilidade de configurar conjuntos individuais a partir do sistema modular, para além dos conjuntos existentes. Apenas tem de escolher as opções adequadas e beneficie de uma instalação rápida.

## SELECIONE O ARO DE EMBELEZAMENTO PREFERIDO...

- 1 Diâmetro de encastramento 68, 75 ou 95 mm
- 2 orientável, rotativo e orientável, IP65
- 3 Cor  
*preto, branco, dourado rosa ou alumínio*
- 4 redondo ou quadrado

## SELECIONE O MÓDULO FAVORITO ADEQUADO ...

- 5 Temperatura de cor  
*2700K ou 3000K, 1800 - 3000K ou CCT 2500 / 3000 / 4000K*
- 6 Ângulo de abertura  
*38° / 60°*

JÁ ESTÁ!



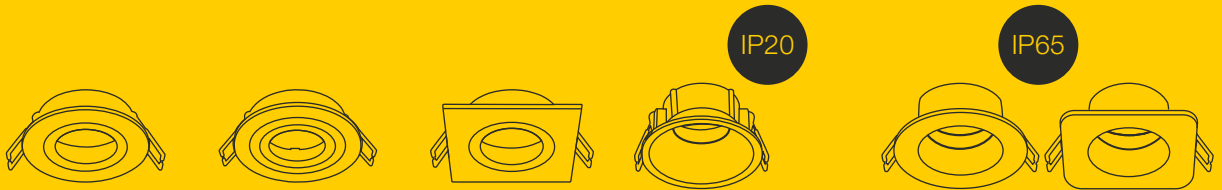

Aro embelezador



Disponível na versão orientável, rotativa e orientável ou na versão IP65 com diâmetro de encastramento de 68, 75 e 95 mm



Disponível nas cores preto, branco, dourado rosa ou alumínio



Disponível na forma redonda ou quadrada

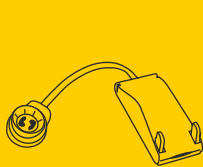

GU10

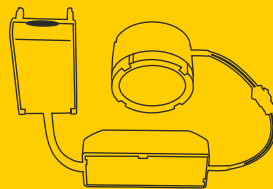

MÓDULO LED

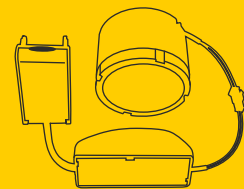

MÓDULO LED



**NEW TRIA® 68**

**NEW TRIA® 75**



**NEW TRIA® 95**



Temperatura de cor  
2700 / 3000K, DTW 1800 - 3000K ou multi CCT



Temperatura de cor  
2700 / 3000K



Ângulo de abertura  
38° / 60°



Ângulo de abertura  
38° / 60°

NEW TRIA® 45  
DL, Redondo

113976 130

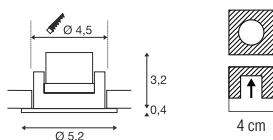

220-240V ~50/60Hz | 700mA  
Potência do sistema: 3,4W  
Material: alumínio/alumínio

- Molas
- Espessura do material da superfície a instalar: máx. 20 mm  
IP 44 (área a iluminar)



Down 190lm | 3000K

Versão	Art. n.º	EUR
● Preto	113970	53,00
○ Branco	113971	53,00
● Alumínio	113976	60,00

113550 131

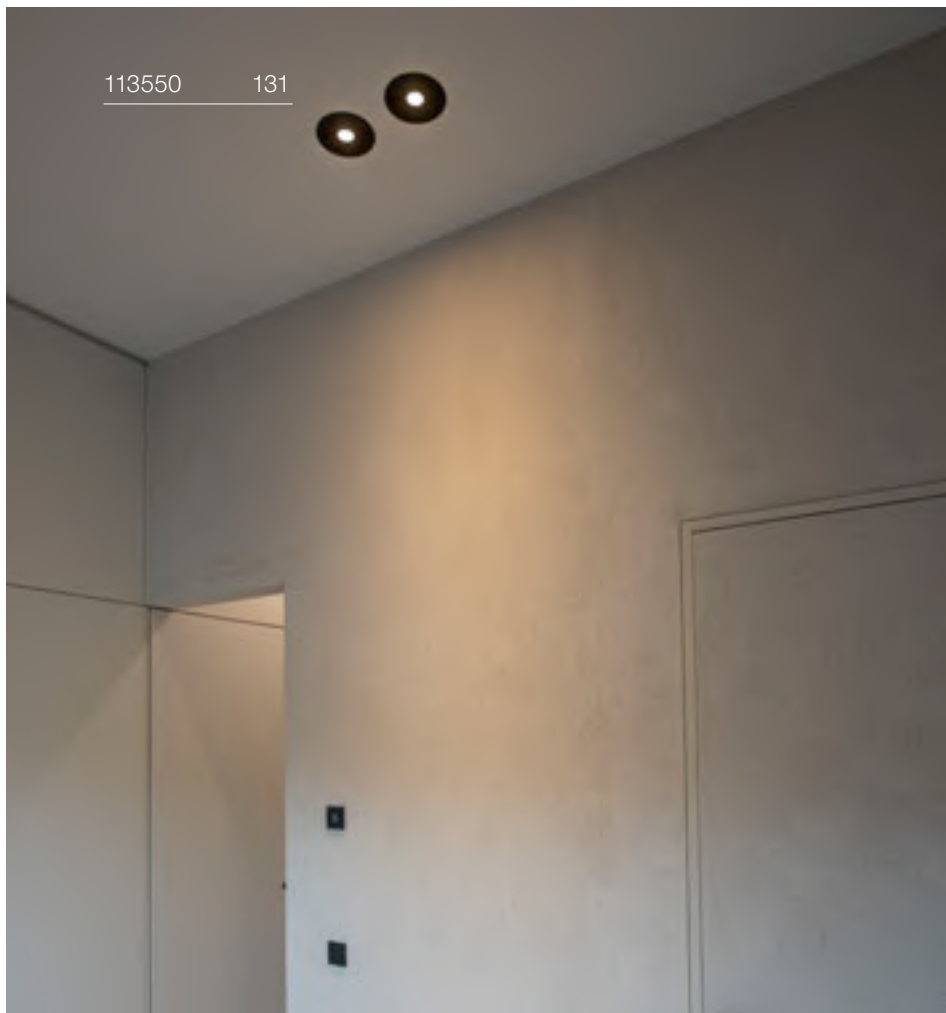



**NEW TRIA® 150**  
DL, Redondo, QPAR111

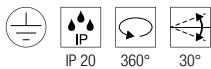
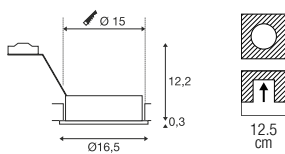

220-240V ~50/60Hz  
Material: alumínio

- Lamelas
- Espessura do material da superfície a instalar: máx. 30 mm



Casquilho: 1xGU10

Versão	Art. n.º	EUR
● Preto	<b>113550</b>	<b>52,00</b>
○ Branco	<b>113540</b>	<b>52,00</b>



QPAR111 | 8W | 38°  
2700K | 680lm | CEE=F  
8kWh/1000h



Art. N.º: 1005274 | 29,90 EUR

**NEW TRIA® 150**  
DL, Quadrado, QPAR111

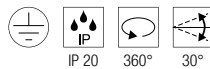
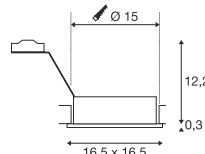

220-240V ~50/60Hz  
Material: alumínio

- Lamelas
- Espessura do material da superfície a instalar: máx. 30 mm



Casquilho: 1xGU10

Versão	Art. n.º	EUR
● Preto	<b>113830</b>	<b>52,00</b>
○ Branco	<b>113541</b>	<b>52,00</b>



QPAR111 mm | 7,3W | 40°  
2700K | 500lm | CEE=G  
8kWh/1000h



Art. N.º: 1005294 | 24,50 EUR

**NEW TRIA® 300**  
DL, Double, QPAR111

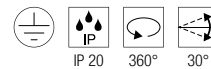
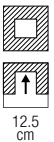
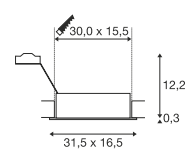

220-240V ~50/60Hz  
Material: alumínio

- Molas
- Espessura do material da superfície a instalar: máx. 30 mm



Casquilho: 2xGU10

Versão	Art. n.º	EUR
● Preto	<b>113840</b>	<b>104,00</b>
○ Branco	<b>113841</b>	<b>104,00</b>
● Alumínio	<b>111382</b>	<b>115,00</b>



QPAR111 | 12,5W | 30°  
2700K | 950lm | CEE=F  
13kWh/1000h



Art. N.º: 1005276 | 49,50 EUR

MEDO® 30  
RL, frame

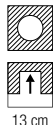
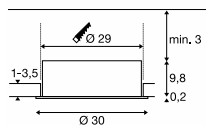

MEDO® 40  
RL, frame

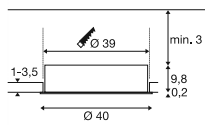

1008631 132

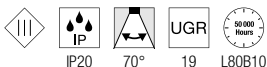

250mA  
Potência do sistema: 8W  
Material: alumínio

- Espessura do material da superfície a instalar: máx. 45 mm

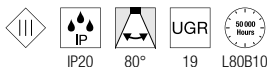

500mA  
Potência do sistema: 16W  
Material: alumínio

- Espessura do material da superfície a instalar: máx. 45 mm



Down 1150lm | 3000K | 1150lm | 4000K

Versão	Art. n.º	EUR
<input type="radio"/> Branco	<b>1008629</b>	<b>159,00</b>



Down 2200lm | 3000K | 2300lm | 4000K

Versão	Art. n.º	EUR
<input type="radio"/> Branco	<b>1008631</b>	<b>199,00</b>



Artigo	Art. n.º	EUR
Driver LED driver 10 W 180-270 mA PHASE	<b>1008660</b>	<b>32,00</b>
Driver LED driver 15W 100-700 mA DALI	<b>1008666</b>	<b>71,00</b>
Driver alívio de tensão Standard	<b>1008672</b>	<b>0,85</b>
Possibilidade repicagem	<b>1008673</b>	<b>2,30</b>



Artigo	Art. n.º	EUR
Driver LED driver 20 W 350-500 mA PHASE	<b>1008663</b>	<b>47,00</b>
Driver LED driver 23W   100-700 mA DALI	<b>1008667</b>	<b>77,00</b>
Driver alívio de tensão Standard	<b>1008672</b>	<b>0,85</b>
Possibilidade repicagem	<b>1008673</b>	<b>2,30</b>



### MEDO® 60 RL, frame

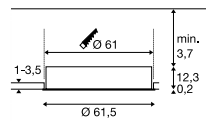

### MEDO® 90 RL, frame

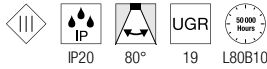
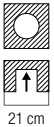
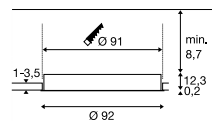

1000mA  
Potência do sistema: 16,5W  
Material: alumínio

- Espessura do material da superfície a instalar: máx. 45 mm



Down 4600lm | 3000K | 4700lm | 4000K

Versão	Art. n.º	EUR
○ Branco	<b>1008633</b>	<b>449,00</b>



Artigo	Art. n.º	EUR
Driver LED driver 40W   700-1050 mA PHASE	<b>1008665</b>	<b>57,00</b>
Driver LED driver 53W   650-1400 mA DALI	<b>1008669</b>	<b>92,00</b>
Driver alívio de tensão Standard	<b>1008674</b>	<b>0,85</b>

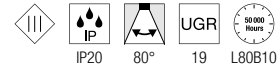

2 x 1000mA  
Potência do sistema: 33W  
Material: alumínio

- Espessura do material da superfície a instalar: máx. 45 mm



Down 8800lm | 3000K | 9100lm | 4000K

Versão	Art. n.º	EUR
○ Branco	<b>1008635</b>	<b>899,00</b>



Artigo	Art. n.º	EUR
Driver LED driver 40W   700-1050 mA PHASE	<b>1008665</b>	<b>57,00</b>
Driver LED driver 53W   650-1400 mA DALI	<b>1008669</b>	<b>92,00</b>
Driver alívio de tensão Standard	<b>1008674</b>	<b>0,85</b>

MEDO® 30  
RL, frameless

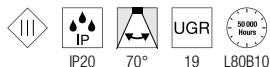
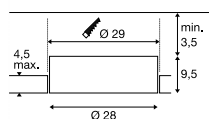

250mA  
Potência do sistema: 8W  
Material: alumínio

- Espessura do material da superfície a instalar: máx. 35 mm



Down 1150lm | 3000K | 1150lm | 4000K

Versão	Art. n.º	EUR
<input type="radio"/> Branco	<b>1008630</b>	<b>159,00</b>



Artigo	Art. n.º	EUR
Driver LED driver 10 W 180-270 mA PHASE	<b>1008660</b>	<b>32,00</b>
Driver LED driver 15W 100-700 mA DALI	<b>1008666</b>	<b>71,00</b>
Driver alívio de tensão Standard	<b>1008672</b>	<b>0,85</b>
Possibilidade repicagem	<b>1008673</b>	<b>2,30</b>

MEDO® 40  
RL, frameless

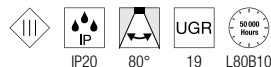
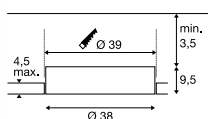

500mA  
Potência do sistema: 16W  
Material: alumínio

- Espessura do material da superfície a instalar: máx. 35 mm



Down 2200lm | 3000K | 2300lm | 4000K

Versão	Art. n.º	EUR
<input type="radio"/> Branco	<b>1008632</b>	<b>199,00</b>



Artigo	Art. n.º	EUR
Driver LED driver 20 W 350-500 mA PHASE	<b>1008663</b>	<b>47,00</b>
Driver LED driver 23W   100-700 mA DALI	<b>1008667</b>	<b>77,00</b>
Driver alívio de tensão Standard	<b>1008672</b>	<b>0,85</b>
Possibilidade repicagem	<b>1008673</b>	<b>2,30</b>

1008636 135



### MEDO® 60 RL, frameless

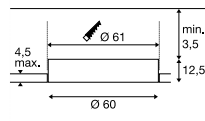

### MEDO® 90 RL, frameless

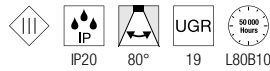
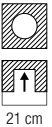
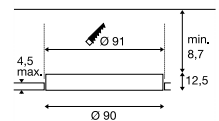

1000mA  
Potência do sistema: 16,5W  
Material: alumínio

- Espessura do material da superfície a instalar: máx. 35 mm



Down 4600lm | 3000K | 4700lm | 4000K

Versão	Art. n.º	EUR
○ Branco	1008634	449,00



Artigo	Art. n.º	EUR
Driver LED driver 40W   700-1050 mA PHASE	1008665	57,00
Driver LED driver 53W   650-1400 mA DALI	1008669	92,00
Driver alívio de tensão Standard	1008674	0,85

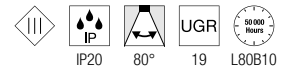

2 x 1000mA  
Potência do sistema: 33W  
Material: alumínio

- Espessura do material da superfície a instalar: máx. 35 mm



Down 8800lm | 3000K | 9100lm | 4000K

Versão	Art. n.º	EUR
○ Branco	1008636	899,00



Artigo	Art. n.º	EUR
Driver LED driver 40W   700-1050 mA PHASE	1008665	57,00
Driver LED driver 53W   650-1400 mA DALI	1008669	92,00
Driver alívio de tensão Standard	1008674	0,85



# HORN MINI EL

113141 137

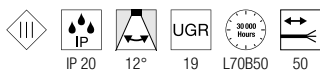
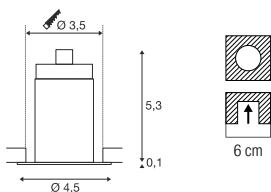

350mA  
Consumo de energia: 1W  
Material: alumínio/policarbonato (PC)

- Molas
- Espessura do material da superfície a instalar: máx. 30 mm
- Com ficha elétrica AMP
- Com refletor dourado, a cor da luz é diferente



Down 70lm | 2900K 3000K

Versão	Art. n.º	EUR
● Preto 3000K	1000915	40,25
● Preto/Dourado 2900K	1000917	43,75
○ Branco 3000K	1000914	40,25



Artigo	Art. n.º	EUR
LED driver 4W   350 mA ○ Branco	1008656 ●	19,00



1000914 218





**HORN**  
DL, single, QPAR51

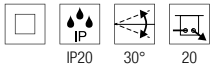
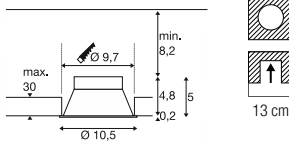

220-240V ~50/60Hz  
Material: alumínio

- Molas
- Espessura do material da superfície a instalar: máx. 30 mm



Casquilho: 1xGU10

Versão	Art. n.º	EUR
● Preto	<b>113140</b>	<b>52,00</b>
○ Branco	<b>113141</b>	<b>52,00</b>



LED GU10 51 mm | 6W | 38°  
2700K | 450lm | CEE=F  
6kWh/1000h



Art. N.º: 1005077 | 7,50 EUR

**HORN**  
DL, double, QPAR51

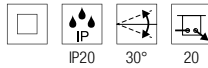
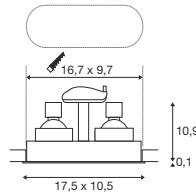

220-240V ~50/60Hz  
Material: alumínio

- Molas
- Espessura do material da superfície a instalar: máx. 30 mm



Casquilho: 2xGU10

Versão	Art. n.º	EUR
● Preto	<b>1006121</b>	<b>75,00</b>
○ Branco	<b>1006122</b>	<b>75,00</b>



LED GU10 51 mm | 5W | 38°  
2700-6500K | 350lm | CEE=G  
5kWh/1000h



Art. N.º: 1005079 | 7,50 EUR

**HORN**  
DL, single, assimétrico, QPAR51

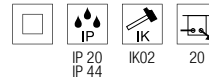
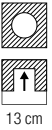
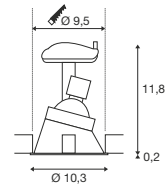

220-240V ~50/60Hz  
Material: alumínio

- Molas
- Espessura do material da superfície a instalar: máx. 30 mm



Casquilho: 1xGU10

Versão	Art. n.º	EUR
● Preto	<b>113150</b>	<b>57,00</b>
○ Branco	<b>113151</b>	<b>57,00</b>



LED GU10 51 mm | 6W | 36°  
2200-2700K | 360lm | CEE=G



Art. N.º: 1005273 | 9,99 EUR

**HORN**  
DL, single, QPAR51

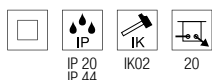
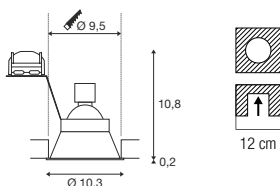

220-240V ~50/60Hz  
Material: alumínio

- Molas
- Espessura do material da superfície a instalar: máx. 25 mm.



Casquilho: 1xGU10

Versão	Art. n.º	EUR
● Preto	113160	35,00
○ Branco	113161	35,00



LED GU10 51 mm | 6W | 38°  
2700K | 450lm | CEE=F  
6kWh/1000h



Art. N.º: 1005077 | 7,50 EUR

**HORN**  
EL, single, QPAR51

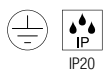
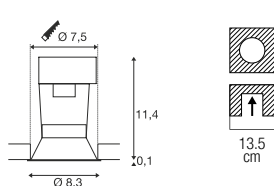

220-240V ~50/60Hz  
Material: aço

- Molas
- Espessura do material da superfície a instalar: máx. 45 mm



Casquilho: 1xGU10 Máx. Ø: 5,1 cm | C: 5,4 cm

Versão	Art. n.º	EUR
● Preto	112910	27,50
○ Branco	112911	27,50



LED GU10 51 mm | 6W | 38°  
2700K | 450lm | CEE=F  
6kWh/1000h



Art. N.º: 1005076 | 7,50 EUR

**HORN**  
DL, GU10, "blower door" testado

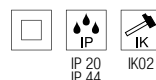
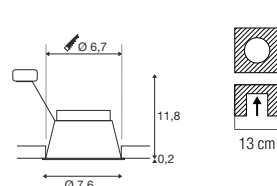

220-240V ~50/60Hz  
Material: alumínio

- O downlight cumpre os requisitos da norma RT2012.
- Espessura do material da superfície a instalar: máx. 30 mm



Casquilho: 1xGU10

Versão	Art. n.º	EUR
● Preto	1005435	26,50
○ Branco	1005436	26,50



LED GU10 51 mm | 6W | 36°  
2200-2700K | 360lm | CEE=G  
6kWh/1000h



Art. N.º: 1005273 | 9,99 EUR



112911 220

### HORN-T EL, QPAR111

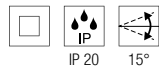
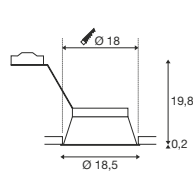

220-240V ~50/60Hz  
Material: aço

- Molas
- Espessura do material da superfície a instalar: máx. 30 mm



Casquilho: 1xGU10

Versão	Art. n.º	EUR
● Preto	113170	69,00
○ Branco	113171	69,00



QPAR111 | 12,5W | 10°  
3000K | 950lm | CEE=F  
13kWh/1000h



Art. N.º: 1005278 | 55,00 EUR

### HORN MAGNA EL

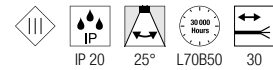
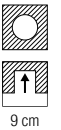
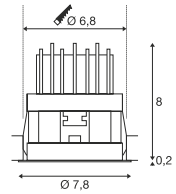

500mA  
Consumo de energia: 9W  
Material: alumínio/policarbonato (PC)

- Com refletor dourado, a cor da luz é diferente
- Molas
- Espessura do material da superfície a instalar: máx. 25 mm.
- Extremidade do cabo aberta



Down 445lm | 3000K  
550lm  
570lm

Versão	Art. n.º	EUR
● Preto	1002592	75,00
● Preto/Dourado	1002594	78,00
○ Branco	1002591	75,00



Artigo	Art. n.º	EUR
LED driver 20W   350mA/500mA   PHASE		
○ Branco	1007227	40,00
LED driver 25W   150-700mA   DALI		
○ Branco	1007229	70,00
Difusor alveolar		
● Preto	1002596	4,00



1002592 221





## SENSER 12 EL, Redondo

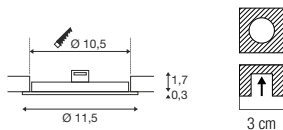

200mA  
Consumo de energia: 6,5W  
Material: alumínio

- Molas
- Espessura do material da superfície a instalar: máx. 15 mm



Down 450lm | 3000K  
470lm | 4000K

Versão	Art. n.º	EUR
○ Branco 450lm   3000K   6,5W	<b>1003008</b>	<b>29,50</b>
○ Branco 470lm   4000K   6W	<b>1004694</b>	<b>29,50</b>



Artigo	Art. n.º	EUR
LED driver 25W   150-700mA   DALI ○ Branco	<b>1007229</b>	<b>70,00</b>

## SENSER 18 EL, Redondo

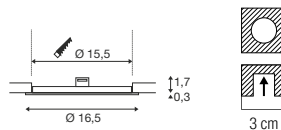

350mA  
Consumo de energia: 10W  
Material: alumínio

- Molas
- Espessura do material da superfície a instalar: máx. 15 mm



Down 890lm | 3000K  
990lm | 4000K

Versão	Art. n.º	EUR
○ Branco 890lm   3000K   10W	<b>1003009</b>	<b>34,00</b>
○ Branco 990lm   4000K   12W	<b>1004695</b>	<b>34,00</b>



Artigo	Art. n.º	EUR
LED driver 20W   350 mA incl. alívio tensão ○ Branco	<b>1007225</b>	<b>30,00</b>
LED driver 20W   350mA   regulável ○ Branco	<b>1007228</b>	<b>40,00</b>
LED driver 25W   150-700mA   DALI ○ Branco	<b>1007229</b>	<b>70,00</b>

## SENSER 24 EL, Redondo

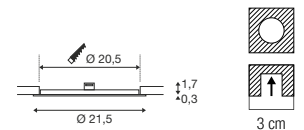

500mA  
Consumo de energia: 13W  
Material: alumínio

- Molas
- Espessura do material da superfície a instalar: máx. 15 mm



Down 1140lm | 3000K  
1300lm | 4000K

Versão	Art. n.º	EUR
○ Branco 1140lm   3000K	<b>1003010</b>	<b>45,25</b>
○ Branco 1300lm   4000K	<b>1004696</b>	<b>45,25</b>



Artigo	Art. n.º	EUR
LED driver 20W   350mA/500mA   PHASE ○ Branco	<b>1007227</b>	<b>40,00</b>
LED driver 25W   150-700mA   DALI ○ Branco	<b>1007229</b>	<b>70,00</b>





## SENSER 12 EL, quadrado

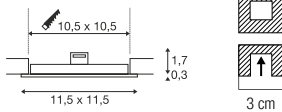

200mA  
Consumo de energia: 6,5W  
Material: alumínio

- Molas
- Espessura do material da superfície a instalar: máx. 15 mm



Down 420lm | 3000K  
440lm | 4000K

Versão	Art. n.º	EUR
○ Branco 3000K	<b>1003011</b>	<b>29,50</b>
○ Branco 4000K	<b>1004697</b>	<b>29,50</b>

Artigo	Art. n.º	EUR
LED driver 25W   150-700mA   DALI ○ Branco	<b>1007229</b>	<b>70,00</b>

## SENSER 18 EL, quadrado

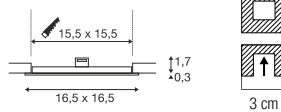

350mA  
Consumo de energia: 10W  
Material: alumínio

- Molas
- Espessura do material da superfície a instalar: máx. 15 mm



Down 780lm | 3000K  
880lm | 4000K

Versão	Art. n.º	EUR
○ Branco 780lm   3000K   10W	<b>1003012</b>	<b>34,00</b>
○ Branco 880lm   4000K   12W	<b>1004698</b>	<b>34,00</b>

Artigo	Art. n.º	EUR
LED driver 20W   350mA incl. alívio tensão ○ Branco	<b>1007225</b>	<b>30,00</b>
LED driver 20W   350mA   regulável ○ Branco	<b>1007228</b>	<b>40,00</b>
LED driver 25W   150-700mA   DALI ○ Branco	<b>1007229</b>	<b>70,00</b>

## SENSER 24 EL, quadrado

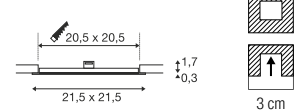

500mA  
Consumo de energia: 13W  
Material: alumínio

- Molas
- Espessura do material da superfície a instalar: máx. 15 mm



Down 1140lm | 3000K  
1240lm | 4000K

Versão	Art. n.º	EUR
○ Branco 1140lm   3000K	<b>1003013</b>	<b>45,25</b>
○ Branco 1240lm   4000K	<b>1004699</b>	<b>45,25</b>

Artigo	Art. n.º	EUR
LED driver 20W   350mA/500mA   PHASE ○ Branco	<b>1007227</b>	<b>40,00</b>
LED driver 25W   150-700mA   DALI ○ Branco	<b>1007229</b>	<b>70,00</b>

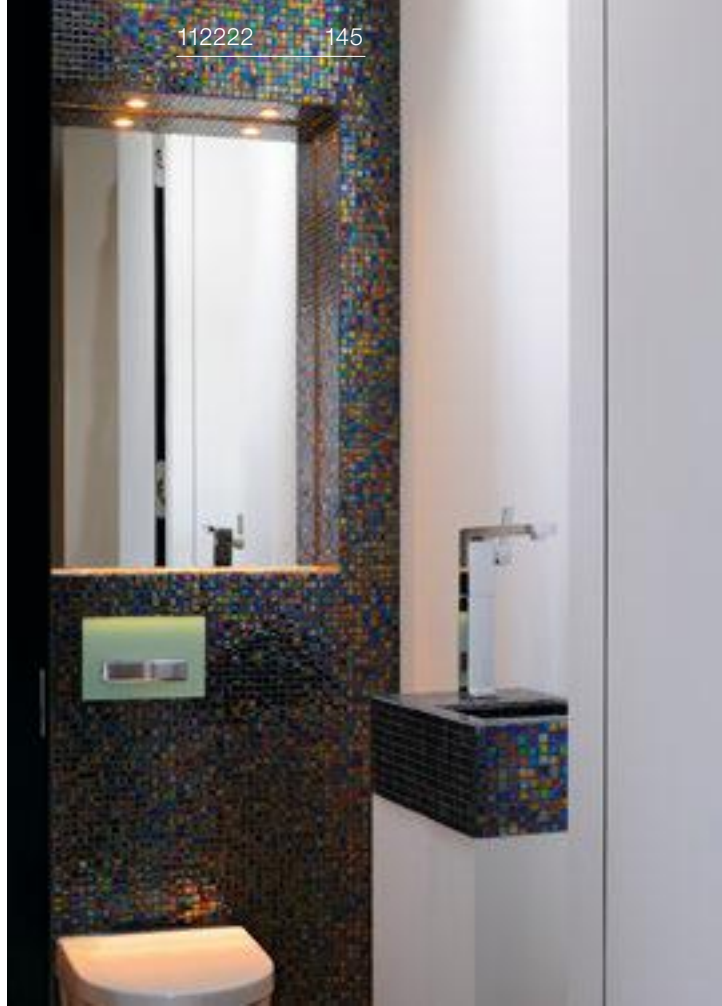





VERLUX  
EL, quadrado, PHASE

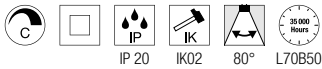
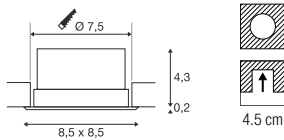

220-240V ~50/60Hz | 500mA  
Potência do sistema: 11W  
Material: alumínio/plástico

- Molas
- Espessura do material da superfície a instalar: máx. 20 mm



Down 940lm | 3000K

Versão	Art. n.º	EUR
○ Branco	112682	90,00

VERLUX  
EL, quadrado, PHASE

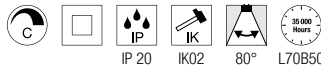
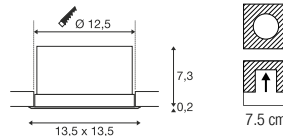

220-240V ~50/60Hz | 500mA  
Potência do sistema: 22W  
Material: alumínio/plástico

- Molas
- Espessura do material da superfície a instalar: máx. 25 mm.



Down 1800lm | 3000K

Versão	Art. n.º	EUR
○ Branco	112692	133,00

DL 126  
EL

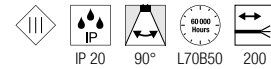
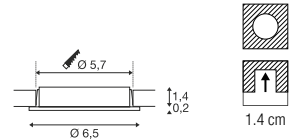

12 VDC  
Consumo de energia: 2,8W  
Material: alumínio/plástico

- Lamelas



Down 170lm | 3000K

Versão	Art. n.º	EUR
○ Branco	112221	36,25
● Cromado	112222	42,25
● Cinzento	112225	36,25



Artigo	Art. n.º	EUR
Fonte de alimentação LED 12 V   24 W, redonda		
○ Branco	1008651	27,00

PIKA  
DL, redondo, QPAR51, fixo

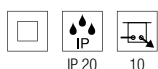
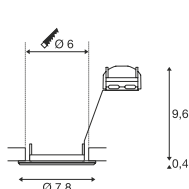

220-240V ~50/60Hz  
Material: alumínio

- Molas
- Espessura do material da superfície a instalar: máx. 13 mm



Casquilho: 1xGU10

Versão	Art. n.º	EUR
○ Branco	1000714	12,70
● Latão	1000716	18,20
● Cromado	1000715	18,20
● Cinzento	1000717	12,70

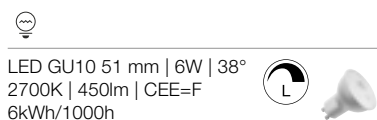

Art. N.º: 1005075 | 7,50 EUR

PIKA  
DL, redondo, QPAR51, orientável

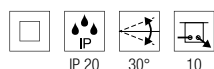
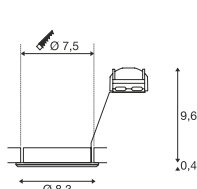

220-240V ~50/60Hz  
Material: alumínio

- Molas
- Espessura do material da superfície a instalar: máx. 15 mm



Casquilho: 1xGU10

Versão	Art. n.º	EUR
○ Branco	1000718	18,20
● Latão	1000720	20,50
● Cromado	1000719	20,50
● Cinzento	1000721	18,20

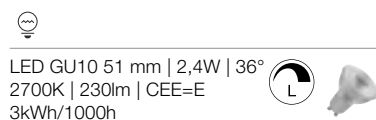

Art. N.º: 1007230 | 5,50 EUR

1000719 146

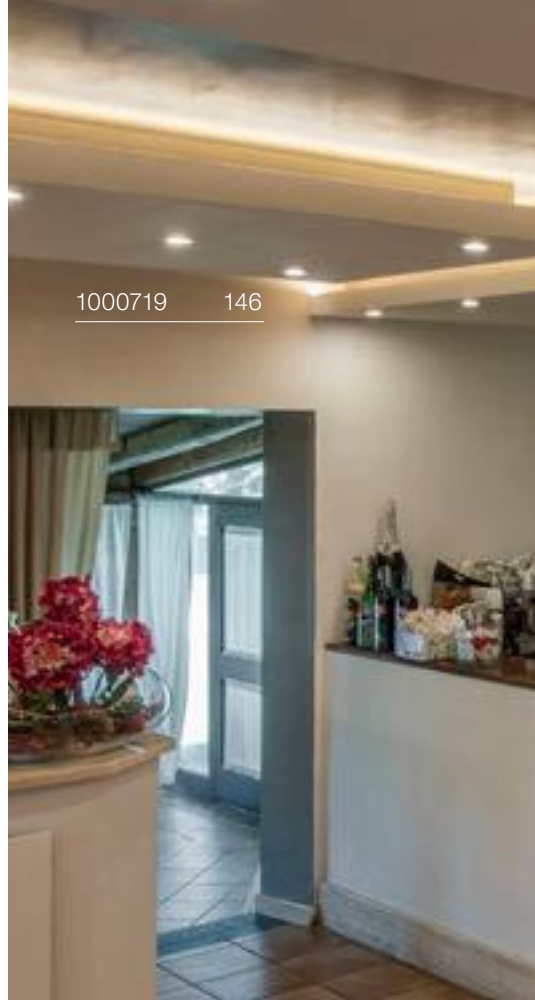



OCULUS  
CL, Move, PHASE

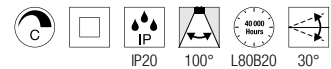
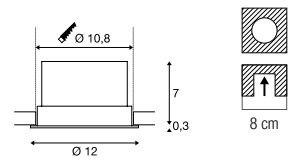

220-240V ~50/60Hz | 250mA  
Potência do sistema: 11W

- Molas
- Incluída lente fosca adicional
- Espessura do material da superfície a instalar: máx. 20 mm



Down 36lm | 2000K - 780lm | 3000K

Versão	Art. n.º	EUR
● Preto	1004668	209,00
○ Branco	1004669	209,00



1004669 147

OCCULDAS 14  
EL, Indireto, PHASE

OCCULDAS 23  
EL, Indireto, PHASE

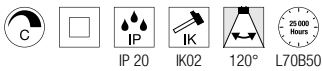
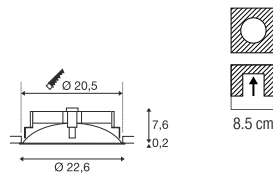
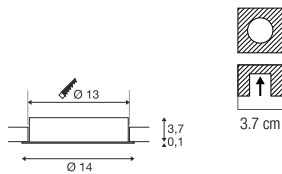

220-240V ~50/60Hz | 350mA  
Potência do sistema: 15W  
Material: alumínio/aço

220-240V ~50/60Hz | 700mA  
Potência do sistema: 23W  
Material: alumínio/aço

- Molas
- Espessura do material da superfície a instalar: máx. 20 mm

- Molas
- Espessura do material da superfície a instalar: máx. 30 mm



Down 810lm | 3000K

Down 1500lm | 3000K

Versão	Art. n.º	EUR
○ Branco	117331	167,00

Versão	Art. n.º	EUR
○ Branco	117311	308,00

117311 148



161271 149





**CONTONE®**  
DL, Redondo, orientável, PHASE

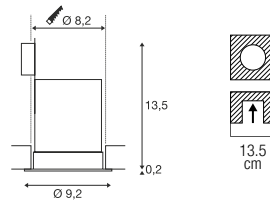

**CONTONE®**  
DL, Redondo, fixo, PHASE

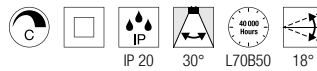
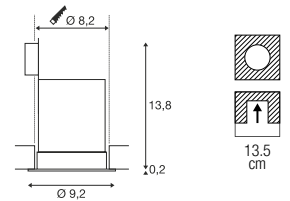

220-240V ~50/60Hz | 350mA  
Potência do sistema: 15W  
Material: alumínio

- Molas
- Espessura do material da superfície a instalar: máx. 25 mm.



Down 1000lm | 2000-3000K -

Versão	Art. n.º	EUR
○ Branco	161271	103,00

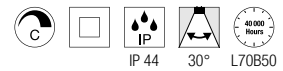

220-240V ~50/60Hz | 350mA  
Potência do sistema: 15W  
Material: alumínio

- Molas
- Espessura do material da superfície a instalar: máx. 25 mm.



Down 1000lm | 2000-3000K -

Versão	Art. n.º	EUR
○ Branco	161291	103,00

# KARPO 30 EL

148071 151

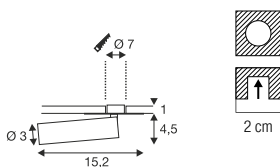

2 cm



500mA  
Potência do sistema: 7,5W  
Material: alumínio/aço

- Espessura do material da superfície a instalar: máx. 12 mm. / Ao ligar várias luminárias, deve-se prestar atenção à ligação em série!
- Molas
- Com ficha elétrica AMP
- Espessura do material da superfície a instalar: máx. 12 mm



Down 450lm | 470lm | 3000K

Versão	Art. n.º	EUR
● Preto 3000K	152380	125,00
○ Branco 4000K	152381	125,00



Artigo	Art. n.º	EUR
LED driver 20W   350mA/500mA   PHASE		
○ Branco	1007227	40,00
LED driver 25W   150-700mA   DALI		
○ Branco	1007229	70,00



152381 150



PLASTRA  
RL, Redondo, QPAR51

PLASTRA  
RL, quadrado, QPAR51

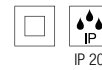
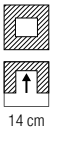
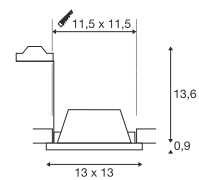
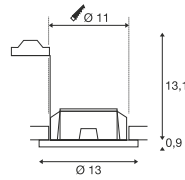

220-240V ~50/60Hz  
Material: gesso/aço

220-240V ~50/60Hz  
Material: gesso/aço

- Molas
- Espessura do material da superfície a instalar: máx. 25 mm.

- Molas
- Espessura do material da superfície a instalar: máx. 30 mm



Casquilho: 1xGU10

Casquilho: 1xGU10

Versão	Art. n.º	EUR
○ Branco	148070	42,25

Versão	Art. n.º	EUR
○ Branco	148071	42,25



LED GU10 51 mm | 6W | 36°  
2200-2700K | 360lm | CEE=G  
6kWh/1000h



Art. N.º: 1005273 | 9,99 EUR



LED GU10 51 mm | 6W | 38°  
2700K | 450lm | CEE=F  
6kWh/1000h



Art. N.º: 1005076 | 7,50 EUR

DEKLED  
EL

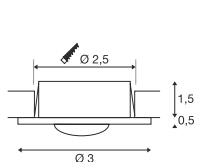

VARU  
EL, QPAR51

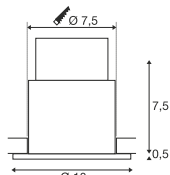

1001931 152

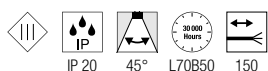

350mA  
Potência do sistema: 1W  
Material: alumínio/policarbonato (PC)

- Espessura do material da superfície a instalar: máx. 15 mm



Down 60lm | 3000K

Versão	Art. n.º	EUR
● Cinzento	112242	31,25

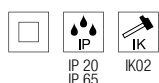

220-240V ~50/60Hz  
Material: alumínio/vidro

- Molas
- Espessura do material da superfície a instalar: máx. 15 mm



Casquilho: 1xGU10 Máx. Ø: 5,1 cm

Versão	Art. n.º	EUR
● Preto	1001930	41,00
○ Branco	1001931	41,00

1001931 152



Artigo	Art. n.º	EUR
LED driver 350mA/6W regulável		
○ Branco	1008698	26,00



LED GU10 51 mm | 6W | 38°  
2700K | 450lm | CEE=F  
6kWh/1000h



Art. N.º: 1005077 | 7,50 EUR





1001165 153



**DOLIX OUT**  
EL, Redondo, QPAR51

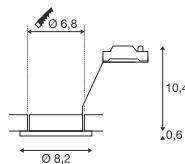

**DOLIX OUT**  
EL, quadrado, QPAR51

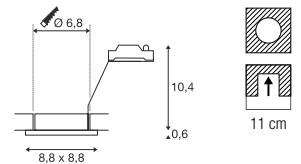

1001172 153

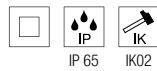

220-240V ~50/60Hz  
Material: alumínio/vidro

- Molas
- Espessura do material da superfície a instalar: máx. 20 mm



Casquilho: 1xGU10

Versão	Art. n.º	EUR
○ Branco	1001165	35,50
● Prateado	1001168	39,50
● Cromado	1001166	39,50
● Cinzento	1001167	35,50



LED GU10 51 mm | 6W | 38°  
2700K | 450lm | CEE=F  
6kWh/1000h

Art. N.º: 1005075 | 7,50 EUR

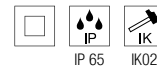

220-240V ~50/60Hz  
Material: alumínio/vidro

- Molas
- Espessura do material da superfície a instalar: máx. 20 mm



Casquilho: 1xGU10

Versão	Art. n.º	EUR
○ Branco	1001169	35,50
● Prateado	1001172	39,50
● Cinzento	1001171	35,50



LED GU10 51 mm | 6W | 38°  
3000K | 470lm | CEE=F  
6kWh/1000h

Art. N.º: 1005078 | 7,50 EUR



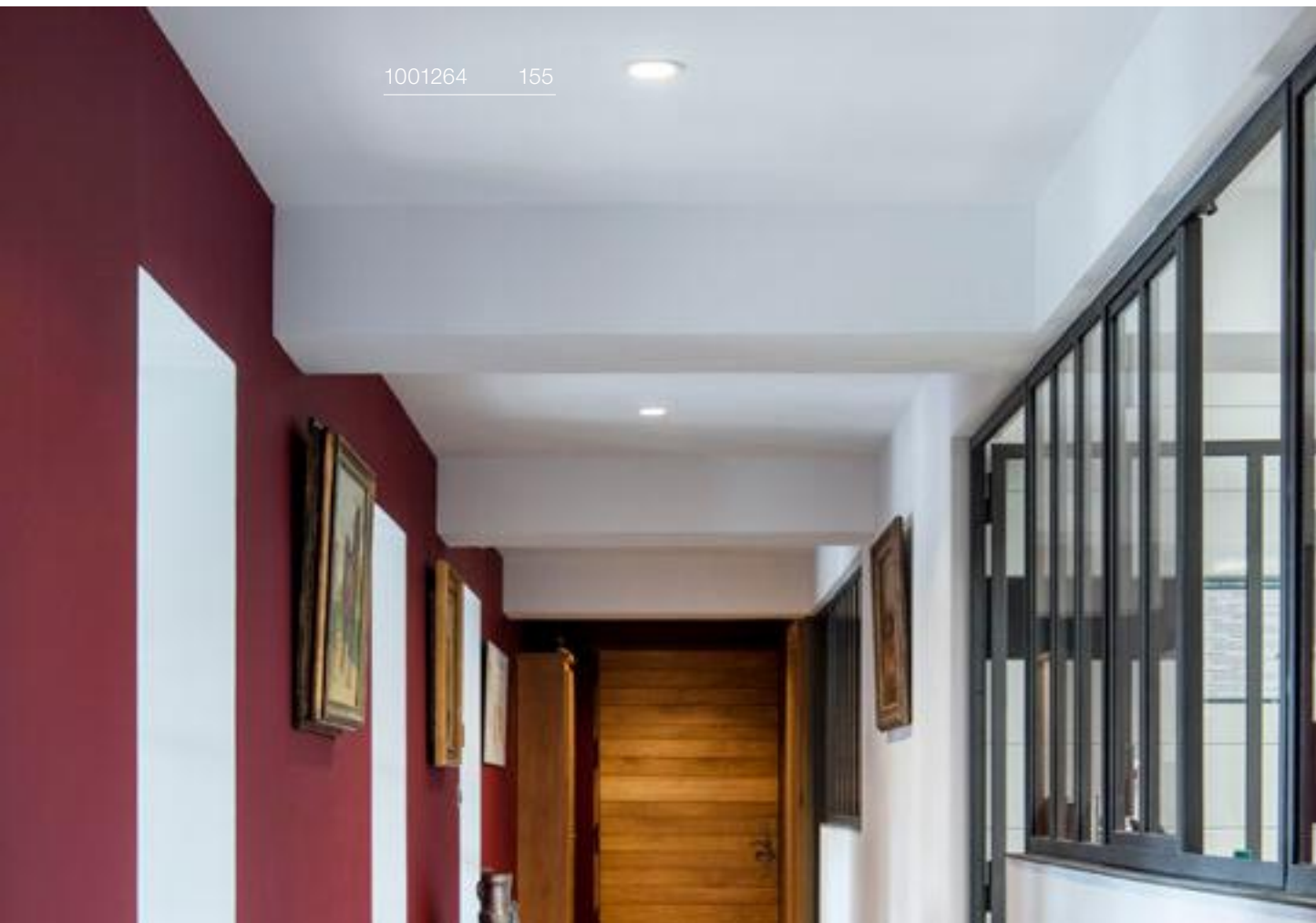



### KAMUELA ECO EL, Redondo, PHASE

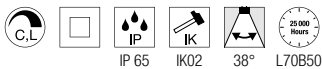
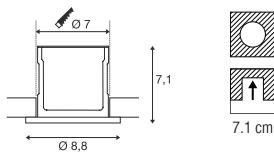

220-240V ~50Hz  
Potência do sistema: 6W  
Material: alumínio/plástico

- Molas
- Espessura do material da superfície a instalar: máx. 40 mm
- Resistente ao fogo durante no mín. 90 minutos, em conformidade com BS 476-21



Down 500lm | 3000K

Versão	Art. n.º	EUR
● Preto	1001015	35,50
○ Branco	1001016	35,50

### KINI EL, PHASE

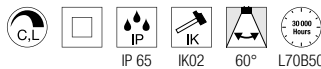
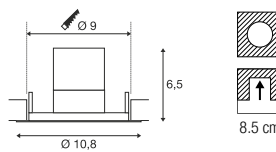

220-240V ~50/60Hz | 260mA  
Potência do sistema: 12W  
Material: alumínio/policarbonato (PC)

- Molas
- Espessura do material da superfície a instalar: máx. 20 mm



Down 850lm | 3000K

Versão	Art. n.º	EUR
○ Branco	1000833	103,00

### AKALO D83 EL

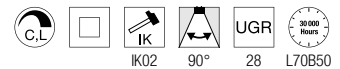
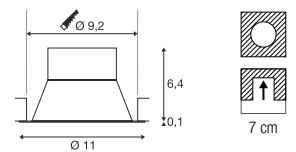

220-240V ~50/60Hz | 120mA  
Potência do sistema: 9W  
Material: alumínio/policarbonato (PC)

- Molas
- Espessura do material da superfície a instalar: máx. 20 mm



800lm | 3000K | 880lm | 4000K | 850lm | 5700K

Versão	Art. n.º	EUR
○ Branco	1001264	40,25

## FRAME BASIC SET RL

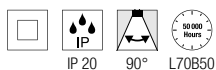
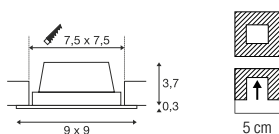

220-240V ~50/60Hz | 350mA  
Potência do sistema: 8,3W  
Material: alumínio/acrílico

- Molas
- Espessura do material da superfície a instalar: máx. 20 mm



Down 600lm | 3000K

Versão	Art. n.º	EUR
● Preto	112720	54,00
○ Branco	112721	54,00

## FRAME BASIC RL, HV

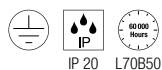
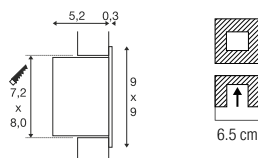

100-240V ~50/60Hz | 350mA  
Potência do sistema: 3W  
Material: alumínio

- Espessura do material da superfície a instalar: máx. 30 mm



Down 170lm | 2700K

Versão	Art. n.º	EUR
○ Branco	1000576	71,00
● Cinzento	1000577	71,00



Artigo	Art. n.º	EUR
Caixa para superfícies rígidas		
● Preto	112781	10,90
Moldura para superfícies ocas		
● Dourado	112780	6,35

## FRAME BASIC RL

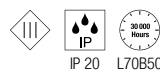
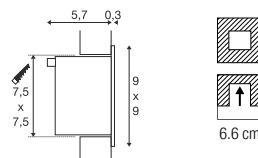

350mA  
Potência do sistema: 1W  
Material: alumínio/vidro

- Ao ligar várias luminárias, deve-se prestar atenção à ligação em série!
- Com ficha elétrica AMP
- Espessura do material da superfície a instalar: máx. 30 mm



Down 40lm | 3000K

Versão	Art. n.º	EUR
○ Branco	113262	40,00
● Cinzento	111262	40,00



Artigo	Art. n.º	EUR
Caixa para superfícies rígidas		
● Preto	112781	10,90
Moldura para superfícies ocas		
● Dourado	112780	6,35
LED driver 4W   350 mA		
○ Branco	1008656	19,00



1000577 156



1000575 157

## FRAME CURVE EL

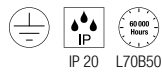
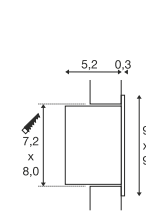

100-240V ~50/60Hz | 350mA  
Potência do sistema: 3W  
Material: alumínio

- Molas
- Espessura do material da superfície a instalar: máx. 30 mm



Down 140lm | 2700K

Versão	Art. n.º	EUR
○ Branco	1000574	77,00
● Cinzento	1000575	77,00



Artigo	Art. n.º	EUR
Caixa para superfícies rígidas		
● Preto	112781	10,90
Moldura para superfícies ocas		
● Dourado	112780	6,35

## FRAME CURVE EL

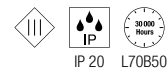
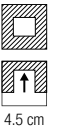
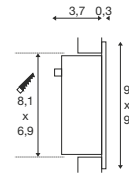

350mA  
Potência do sistema: 1W  
Material: alumínio

- Ao ligar várias luminárias, deve-se prestar atenção à ligação em série!
- Lamelas
- Com ficha elétrica AMP
- Espessura do material da superfície a instalar: máx. 25 mm.



Down 60lm | 3000K

Versão	Art. n.º	EUR
○ Branco	113292	54,00
● Cinzento	111292	54,00



Artigo	Art. n.º	EUR
Caixa para superfícies rígidas		
● Preto	112781	10,90
Moldura para superfícies ocas		
● Dourado	112780	6,35
LED driver 4W   350 mA		
○ Branco	1008656	19,00

1002980 159





## NOTAPO S RL

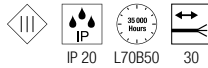
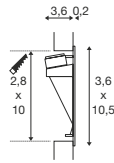

700mA  
Consumo de energia: 2,2W  
Material: alumínio

- Ao ligar várias luminárias, deve-se prestar atenção à ligação em série!
- Lamelas
- Extremidade do cabo aberta



Down 6lm | 3000K

Versão	Art. n.º	EUR
<input type="radio"/> Branco	<b>1002979</b>	<b>60,00</b>



Artigo	Art. n.º	EUR
LED driver 25W   150-700mA   DALI		
<input type="radio"/> Branco	<b>1007229</b>	<b>70,00</b>
NOTAPO   Caixa de montagem para encastrar		
<input checked="" type="radio"/> Preto	<b>1002981</b>	<b>24,25</b>

## NOTAPO L RL

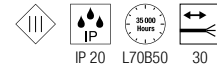
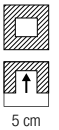
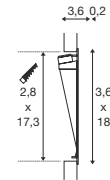

700mA  
Consumo de energia: 2,2W  
Material: alumínio

- Ao ligar várias luminárias, deve-se prestar atenção à ligação em série!
- Lamelas
- Extremidade do cabo aberta



Down 6lm | 3000K

Versão	Art. n.º	EUR
<input type="radio"/> Branco	<b>1002980</b>	<b>82,00</b>



Artigo	Art. n.º	EUR
LED driver 25W   150-700mA   DALI		
<input type="radio"/> Branco	<b>1007229</b>	<b>70,00</b>
NOTAPO   Caixa de montagem para encastrar		
<input checked="" type="radio"/> Preto	<b>1002981</b>	<b>24,25</b>

## DOWNUNDER PUR 80 EL

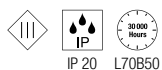
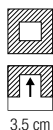
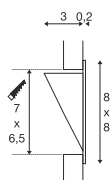

350mA  
Potência do sistema: 3,6W  
Material: alumínio/aço

- Ao ligar várias luminárias, deve-se prestar atenção à ligação em série!
- Lamelas



Down 180lm | 3000K

Versão	Art. n.º	EUR
<input type="radio"/> Branco	<b>151950</b>	<b>60,00</b>



Artigo	Art. n.º	EUR
Caixa de montagem para encastrar		
<input checked="" type="radio"/> Cinzento	<b>151960</b>	<b>9,05</b>
LED driver 4W   350 mA		
<input type="radio"/> Branco	<b>1008656</b>	<b>19,00</b>

## DOWNUNDER PUR 150 EL

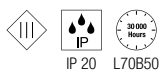
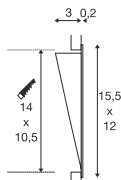

500mA  
Potência do sistema: 5,2W  
Material: alumínio/aço

- Ao ligar várias luminárias, deve-se prestar atenção à ligação em série!
- Lamelas



Down 230lm | 3000K

Versão	Art. n.º	EUR
<input type="radio"/> Branco	<b>151952</b>	<b>86,00</b>



Artigo	Art. n.º	EUR
Caixa de montagem para encastrar		
<input checked="" type="radio"/> Cinzento	<b>151962</b>	<b>12,90</b>
LED driver 20W   350mA/500mA   PHASE		
<input type="radio"/> Branco	<b>1007227</b>	<b>40,00</b>
LED driver 25W   150-700mA   DALI		
<input type="radio"/> Branco	<b>1007229</b>	<b>70,00</b>







## MOBALA EL

## WORO EL

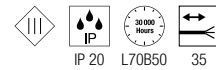
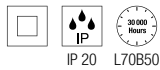
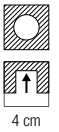
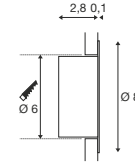
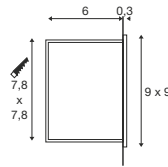

100-240V ~50/60Hz | 24V  
Potência do sistema: 1,3W  
Material: alumínio

350mA  
Potência do sistema: 1,2W  
Material: aço

- Para a montagem é necessário a caixa para superfícies rígidas (1002983) ou a moldura para superfícies ocas (1002984).
- Lamelas

- Ao ligar várias luminárias, deve-se prestar atenção à ligação em série!
- O artigo é adequado para instalação em paredes ocas e caixas de aparelhagem para interruptores/tomadas.
- Lamelas
- Extremidade do cabo aberta



Down 40lm | 3000K

Down 50lm | 3000K

Versão	Art. n.º	EUR
○ Branco	<b>1002982</b>	<b>72,00</b>

Versão	Art. n.º	EUR
○ Branco	<b>1002922</b>	<b>70,00</b>



Artigo	Art. n.º	EUR
MOBALA   Caixa para superfícies rígidas		
● Preto	<b>1002983</b>	<b>13,90</b>
MOBALA   Moldura para superfícies ocas		
● Preto	<b>1002984</b>	<b>13,90</b>

Artigo	Art. n.º	EUR
LED Treiber 4W   350mA		
○ Branco	<b>1008656</b>	<b>19,00</b>

151952 160

PATTA-I  
EL, Redondo, PHASE

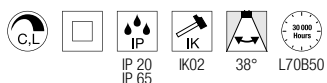
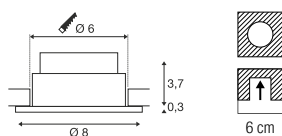

220-240V ~50/60Hz | 350mA  
Potência do sistema: 7,3W  
Material: alumínio/vidro

- Molas. Inclui também um conjunto de lamelas
- Espessura do material da superfície a instalar: máx. 20 mm



Down 440lm | 1800-3000K

Versão	Art. n.º	EUR
● Preto	1002098	86,00
○ Branco	1002099	86,00
● Alumínio	1002100	90,00

PATTA-I  
DL, Quadrado, PHASE

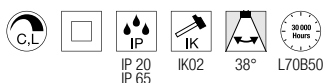
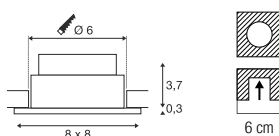

220-240V ~50/60Hz | 350mA  
Potência do sistema: 7,3W  
Material: alumínio/vidro

- Molas. Inclui também um conjunto de lamelas
- Espessura do material da superfície a instalar: máx. 20 mm



Down 440lm | 1800-3000K

Versão	Art. n.º	EUR
● Preto	1002101	86,00
○ Branco	1002102	86,00

1002099 162



1002101 162





1002098 162

PATTA-I  
EL, Redondo, PHASE

PATTA-I  
EL, quadrado, PHASE

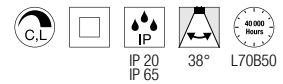
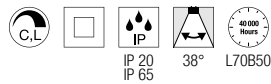
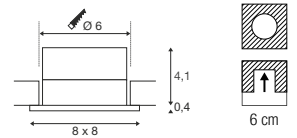
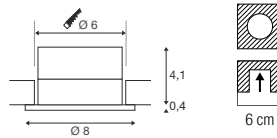

220-240V ~50/60Hz | 500mA  
Potência do sistema: 11W  
Material: alumínio/vidro

220-240V ~50/60Hz | 500mA  
Potência do sistema: 11W  
Material: alumínio/vidro

- Molas
- Espessura do material da superfície a instalar: máx. 25 mm.

- Molas
- Espessura do material da superfície a instalar: máx. 25 mm.

114431 163



Down 910lm | 3000K

Down 910lm | 3000K

Versão	Art. n.º	EUR
● Preto	114420	86,00
○ Branco	114421	86,00
● Alumínio	114426	90,00

Versão	Art. n.º	EUR
● Preto	114430	86,00
○ Branco	114431	86,00
● Alumínio	114436	90,00

# PATTA-F

## EL, Redondo, PHASE

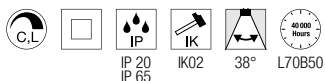
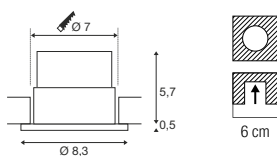

220-240V ~50/60Hz | 500mA

Potência do sistema: 11W

Material: alumínio/vidro

- Molas
- Espessura do material da superfície a instalar: máx. 20 mm



Down 745lm | 860lm | 3000K

Versão	Art. n.º	EUR
● Preto		
745lm	<b>114440</b>	<b>97,00</b>
○ Branco		
860lm	<b>114441</b>	<b>97,00</b>





114450 165

PATTA-F  
EL, quadrado, PHASE

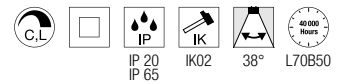
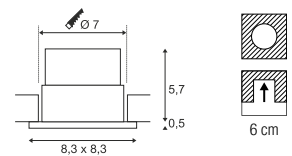





















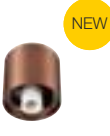

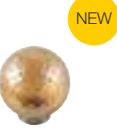









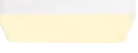
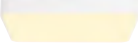







220-240V ~50/60Hz | 500mA  
Potência do sistema: 11W  
Material: alumínio/vidro

- Molas
- Espessura do material da superfície a instalar: máx. 20 mm



Down 745lm | 3000K  
860lm

Versão	Art. n.º	EUR
● Preto		
745lm	<b>114450</b>	<b>97,00</b>
○ Branco		
860lm	<b>114451</b>	<b>97,00</b>

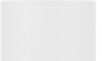
 <b>SCKET</b> SUN 20   168	 <b>SCKET</b> SUN 30   169	 <b>SCKET</b> KAMI   170	 <b>SCKET</b> KAMI   171	 <b>SCKET</b> KAMI   171	 <b>SCKET</b> KAMI   171
 <b>LED</b> ONE 40   173	 <b>LED</b> ONE 60   173	 <b>LED</b> ONE 40   175	 <b>LED</b> ONE 60   175	 <b>SCKET</b> VARYT   177	 <b>VARYT</b> VARYT   177
 <b>VARYT</b> VARYT   177	 <b>VARYT</b> VARYT   177	 <b>VARYT</b> VARYT   177	 <b>LED</b> TRILEDO   181	 <b>LED</b> TRILEDO   181	 <b>LED</b> TRILEDO   181
 <b>LED</b> NUMINOS° S   182	 <b>LED</b> NUMINOS° M   184	 <b>LED</b> NUMINOS° L   186	 <b>LED</b> NUMINOS° XL   188	 <b>LED</b> MEDO°   191	 <b>LED</b> MEDO°   191
 <b>SCKET</b> TRILEDO   193	 <b>SCKET</b> TRILEDO   193	 <b>SCKET</b> TRILEDO   193	 <b>LED</b> OCULUS   195	 <b>LED</b> OCULUS   196	 <b>SCKET</b> ENOLA B   197
 <b>LED</b> ENOLA C   197	 <b>SCKET</b> ASTINA   198	 <b>LED</b> ANELA   199	 <b>SCKET</b> ASTO TUBE   201	 <b>LED</b> OCCULDAS 13   202	 <b>LED</b> OCCULDAS 23   202
 <b>SCKET</b> ALTRA DICE   203	 <b>SCKET</b> ALTRA DICE   203	 <b>SCKET</b> KARDAMOD   205	 <b>SCKET</b> KARDAMOD   205	 <b>SCKET</b> FENDA   206	 <b>FENDA</b> FENDA   207



FENDA | 207



FENDA | 207



**SCKET**  
TENORA | 208



**SCKET**  
SOPRANA | 209



**SCKET**  
PLASTRA | 210



**LED**  
PLASTRA | 211



**SCKET**  
PLASTRA 105 | 211



**SCKET**  
PLASTRA 104 | 211



**LED**  
FERA 25 | 212



**LED**  
FERA 25 | 212



**LED**  
MARONA | 213



**LED**  
Q-LINE® | 215



**LED**  
Q-LINE® | 215



**LED**  
PANEL 60 | 217



**LED**  
PANEL 60 | 217

SUN 20  
CL, E27

NEW

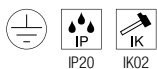
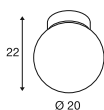

220-240V ~50/60Hz  
Material: vidro/aço



Casquilho: 1xE27 máx. Ø: 4,5 cm | C: 12 cm

versão	Art. n.º	EUR
● Preto	1008125	● 109,00
● Dourado	1008126	● 115,00



LED T38 | 8W | 300°  
4000K | 920lm | CEE=E  
8kWh/1000h



Art. N.º: 1005290 | 10,25 EUR







SUN 30  
CL, E27

NEW

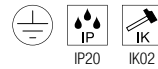
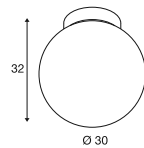

IP20

IK02

220-240V ~50/60Hz  
Material: vidro/aço

**SOCKET  
INSIDE** 60  
W

Casquilho: 1xE27 máx. Ø: 4,5 cm | C: 14 cm

versão	Art. n.º	EUR
● Preto	<b>1008127</b>	● <b>119,00</b>
● Dourado	<b>1008128</b>	● <b>125,00</b>



LED T38 | 8W | 300°  
4000K | 920lm | CEE=E  
8kWh/1000h



Art. N.º: 1005290 | 10,25 EUR

1007732 171



KAMI  
CL, single, QPAR51

NEW

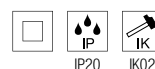
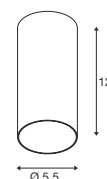

220-240V ~50/60Hz  
Material: alumínio

SOCKET  
INSIDE 10 W

Casquilho: 1xGU10

máx. Ø: 5,1 cm

versão	Art. n.º	EUR
● Preto	1007715	49,00
● Preto/dourado	1007711	49,00
○ Branco	1007714	49,00
● Branco/Preto	1007712	49,00
○ Branco/dourado	1007710	49,00



LED GU10 51 mm | 6W | 38°  
2700K | 450lm | CEE=F  
6kWh/1000h



Art. N.º: 1005076 | 7,50 EUR

1007739 171





**KAMI**  
CL, double, QPAR51

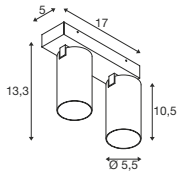

220-240V ~50/60Hz  
Material: alumínio



Casquilho: 2xGU10 máx. Ø: 5,1 cm

versão	Art. n.º	EUR
● Preto	1007727	100,00
● Preto/dourado	1007723	100,00
○ Branco	1007726	100,00
○ Branco/Preto	1007724	100,00
○ Branco/dourado	1007722	100,00



LED GU10 51 mm | 6W | 38°  
2700K | 450lm | CEE=F  
6kWh/1000h



Art. N.º: 1005076 | 7,50 EUR

**KAMI**  
CL, double, long, QPAR51

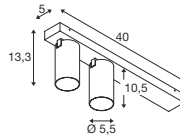

220-240V ~50/60Hz  
Material: alumínio



Casquilho: 2xGU10 máx. Ø: 5,1 cm

versão	Art. n.º	EUR
● Preto	1007733	119,00
● Preto/dourado	1007729	119,00
○ Branco	1007732	119,00
○ Branco/Preto	1007730	119,00
○ Branco/dourado	1007728	119,00



LED GU10 51 mm | 6W | 38°  
2700K | 450lm | CEE=F  
6kWh/1000h



Art. N.º: 1005077 | 7,50 EUR

**KAMI**  
CL, triple, long, QPAR51

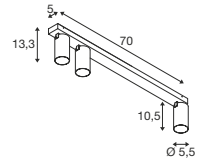

220-240V ~50/60Hz  
Material: alumínio



Casquilho: 3xGU10 máx. Ø: 5,1 cm

versão	Art. n.º	EUR
● Preto	1007739	158,00
● Preto/dourado	1007735	158,00
○ Branco	1007738	158,00
○ Branco/Preto	1007736	158,00
○ Branco/dourado	1007734	158,00



LED QPAR51 | 6W | 38°  
3000K | 450lm | CEE=F  
6kWh/1000h



Art. N.º: 1005079 | 7,50 EUR



1008546 173





ONE 40  
CL, Phase, up/down

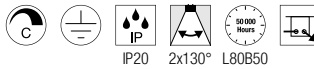
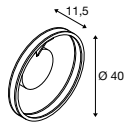

220-240V ~50/60Hz | 350mA  
Potência do sistema: 14W  
Material: alumínio/aço



Up	450lm	2700K	450lm	3000K
Down	450lm		450lm	

versão	Art. n.º	EUR
● Preto	1008547	329,00
○ Branco	1008546	329,00
● Latão	1008545	329,00

ONE 60  
CL, Phase, up/down

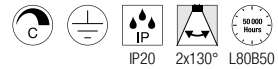
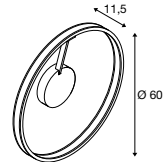

220-240V ~50/60Hz | 600mA  
Potência do sistema: 23W  
Material: alumínio/aço



Up	550lm	2700K	550lm	3000K
Down	750lm		800lm	

versão	Art. n.º	EUR
● Preto	1008550	389,00
○ Branco	1008549	389,00
● Latão	1008548	389,00

1008546 175





ONE 40  
CL, DALI, up/down

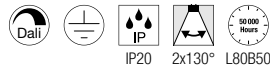
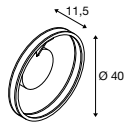

220-240V ~50/60Hz | 350mA  
Potência do sistema: 14W  
Material: alumínio/aço



Up	450lm	2700K	450lm	3000K
Down	450lm		450lm	

versão	Art. n.º	EUR
● Preto	1008553	399,00
○ Branco	1008552	399,00
● Latão	1008551	399,00

ONE 60  
CL, DALI, up/down

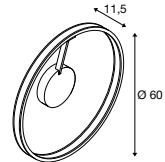

220-240V ~50/60Hz | 600mA  
Potência do sistema: 23W  
Material: alumínio/aço



Up	550lm	2700K	550lm	3000K
Down	750lm		850lm	
	750lm		800lm	

versão	Art. n.º	EUR
● Preto		
550/550lm	1008556	469,00
○ Branco		
750/850lm	1008555	469,00
● Latão		
750/850lm	1008554	469,00

1008101 + 1007859 177







### VARYT CL, E14

MIX  
match

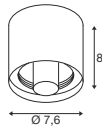

220-240V ~50/60Hz  
Material: alumínio



Casquilho: 1xE14 máx. Ø: 11 cm | C: 3,8 cm

versão	Art. n.º	EUR
● Preto	1008099	99,00
○ Branco	1008100	99,00
● Latão (PVD)	1008102	129,00
● Cromado	1008101	119,00
● Cobre (PVD)	1008103	129,00



C35 | 4,2W | 320°  
2700K | 380lm | CEE=F  
5kWh/1000h



Art. N.º: 1005284 | 6,50 EUR

### VARYT Difusor em vidro p/ PD, WL, CL, TL

MIX  
match



A: 12,8 cm  
Ø: 12 cm  
Material: vidro

versão	Art. n.º	EUR
○ Branco	1008119	59,00

### VARYT Difusor em vidro diamante p/ PD, WL, CL, TL

MIX  
match

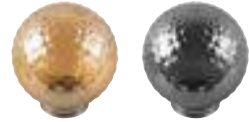

A: 12,7 cm  
Ø: 12 cm  
Material: vidro

versão	Art. n.º	EUR
● Âmbar	1008023	79,00
● Fumado	1007858	79,00

### VARYT Difusor em vidro estriado p/ PD, WL, CL, TL

MIX  
match



A: 13 cm  
Ø: 12 cm  
Material: vidro

### VARYT Difusor em vidro plissado p/ PD, WL, CL, TL

MIX  
match



A: 13,5 cm  
Ø: 11,5 cm  
Material: vidro

versão	Art. n.º	EUR
○ Branco	1007859	69,00

versão	Art. n.º	EUR
○ Branco	1007860	75,00

# MIX & MATCH VARYT

## VARYT PD

Preto		1008114
Branco		1008115
Latão		1008117
Cromado		1008116
Cobre		1008118

## VARYT CL

Preto		1008099
Branco		1008100
Latão		1008102
Cromado		1008101
Cobre		1008103

## VARYT WL

Preto		1008104
Branco		1008105
Latão		1008107
Cromado		1008106
Cobre		1008108

## VARYT TL

Preto		1008109
Branco		1008110
Latão		1008112
Cromado		1008111
Cobre		1008113

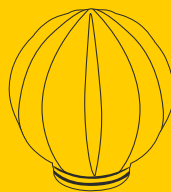
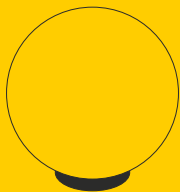
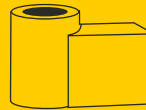
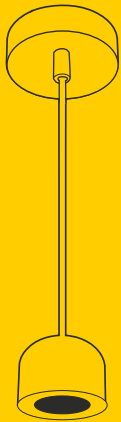

## VARYT ESFERA Ø12

Branco | 1008119

## VARYT ESTRIADO Ø12

Branco | 1007859

## VARYT PLISSADO Ø11,5

Branco | 1007860



Adequado a todas as versões da família VARYT (mesa, parede, teto e suspensa).

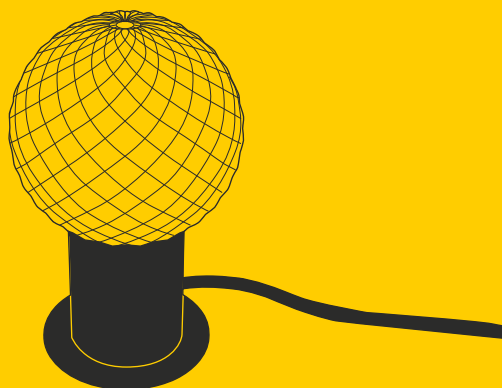
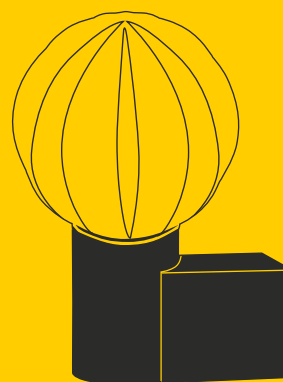
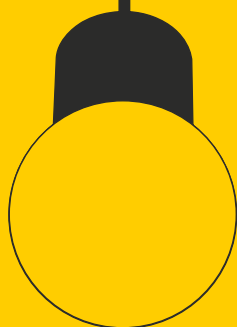

### VARYT DIAMANTE Ø11

Smoked | 1007858  
Âmbar | 1008023

Combine a família SLV Mix & Match totalmente de acordo com o seu gosto. Perfeitamente coordenados, podem ser combinados com a família Varyt. Identifica os artigos SLV Mix & Match pelo símbolo seguinte:



**MIX**  
match

113940 181



113931 181



1002003 181





**TRILEDO**  
CL, double, Quadrado

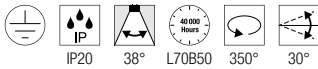
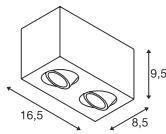

220-240V ~50/60Hz | 350mA  
Potência do sistema: 14W  
Material: alumínio



Down 1300lm | 3000K

versão	Art. n.º	EUR
● Preto	1002003	163,00
○ Branco	1002008	163,00

**TRILEDO**  
CL, single, Redondo

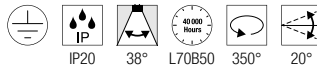
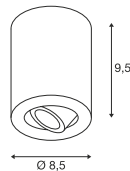

220-240V ~50/60Hz | 350mA  
Potência do sistema: 7,6W  
Material: alumínio/alumínio



Down 640lm | 3000K

versão	Art. n.º	EUR
● Preto	113930	117,00
○ Branco	113931	117,00

**TRILEDO**  
CL, single, Quadrado

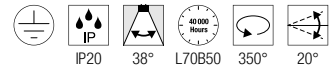
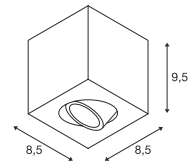

220-240V ~50/60Hz | 350mA  
Potência do sistema: 7,6W  
Material: alumínio/alumínio



Down 640lm | 3000K

versão	Art. n.º	EUR
● Preto	113940	117,00
○ Branco	113941	117,00

# NUMINOS® S CL



● Preto

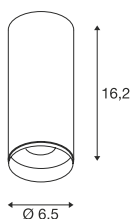

○ Branco



200mA  
220-240V ~50/60Hz  
Potência do sistema: 8,6W  
Material: alumínio/policarbonato (PC)











versão	EUR
Versões S	102,00
Versões S DALI	150,00

**Nota:**  
Anel decorativo também disponível em branco, dourado e cobre



versão	Art. n.º	EUR
Anel decorativo S		
○ Branco	1006167	1,30
Anel decorativo S		
● Dourado	1008144	8,00
Anel decorativo S		
● Cobre	1008140	8,00



				UGR	Art. N.º	
	2700K	930lm	24°	16	<b>1004122</b>	
		944lm	36°	16	<b>1004123</b>	
		960lm	60°	19	<b>1004124</b>	
	3000K	1016lm	24°	13	<b>1004130</b>	
		1037lm	36°	13	<b>1004131</b>	
		1042lm	60°	19	<b>1004132</b>	
	4000K	1074lm	24°	16	<b>1004138</b>	
		1092lm	36°	16	<b>1004139</b>	
		1098lm	60°	19	<b>1004140</b>	
	2700K	930lm	24°	16	<b>1004410</b>	
		944lm	36°	16	<b>1004411</b>	
		960lm	60°	19	<b>1004412</b>	
	3000K	1016lm	24°	13	<b>1004418</b>	
		1037lm	36°	13	<b>1004419</b>	
		1042lm	60°	19	<b>1004420</b>	
	4000K	1074lm	24°	16	<b>1004426</b>	
		1092lm	36°	16	<b>1004427</b>	
		1098lm	60°	19	<b>1004428</b>	
	2700K	930lm	24°	16	<b>1004126</b>	
		944lm	36°	16	<b>1004127</b>	
		960lm	60°	19	<b>1004128</b>	
	3000K	1016lm	24°	13	<b>1004134</b>	
		1037lm	36°	13	<b>1004135</b>	
		1042lm	60°	19	<b>1004136</b>	
	4000K	1074lm	24°	16	<b>1004142</b>	
		1092lm	36°	16	<b>1004143</b>	
		1098lm	60°	19	<b>1004144</b>	
	2700K	930lm	24°	16	<b>1004414</b>	
		944lm	36°	16	<b>1004415</b>	
		960lm	60°	19	<b>1004416</b>	
	3000K	1016lm	24°	13	<b>1004422</b>	
		1037lm	36°	13	<b>1004423</b>	
		1042lm	60°	19	<b>1004424</b>	
	4000K	1074lm	24°	16	<b>1004430</b>	
		1092lm	36°	16	<b>1004431</b>	
		1098lm	60°	19	<b>1004432</b>	

# NUMINOS® M CL



● Preto

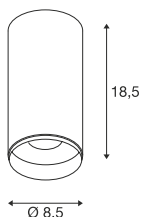

○ Branco



**350mA**  
220-240V ~50/60Hz  
Potência do sistema: 14W  
Material: alumínio/policarbonato (PC)

versão	EUR
Versões M	126,00
Versões M DALI	155,00



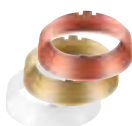







**Nota:**  
Anel decorativo também disponível em branco, dourado e cobre



versão	Art. n.º	EUR
Anel decorativo M		
○ Branco	1006168	2,40
Anel decorativo M		
● Dourado	1008145	9,00
Anel decorativo M		
● Cobre	1008141	9,00





				UGR	Art. N.º	
	2700K	1750lm	24°	16	<b>1004218</b>	
		1744lm	36°	16	<b>1004219</b>	
		1697lm	60°	22	<b>1004220</b>	
	3000K	1804lm	24°	16	<b>1004226</b>	
		1790lm	36°	13	<b>1004227</b>	
		1749lm	60°	22	<b>1004228</b>	
	4000K	1931lm	24°	19	<b>1004234</b>	
		1927lm	36°	16	<b>1004235</b>	
		1872lm	60°	25	<b>1004236</b>	
	2700K	1750lm	24°	16	<b>1004506</b>	
		1744lm	36°	16	<b>1004507</b>	
		1697lm	60°	22	<b>1004508</b>	
	3000K	1804lm	24°	16	<b>1004514</b>	
		1790lm	36°	13	<b>1004515</b>	
		1749lm	60°	22	<b>1004516</b>	
	4000K	1931lm	24°	19	<b>1004522</b>	
		1927lm	36°	16	<b>1004523</b>	
		1872lm	60°	25	<b>1004524</b>	
	2700K	1750lm	24°	16	<b>1004222</b>	
		1744lm	36°	16	<b>1004223</b>	
		1697lm	60°	22	<b>1004224</b>	
	3000K	1804lm	24°	16	<b>1004230</b>	
		1790lm	36°	13	<b>1004231</b>	
		1749lm	60°	22	<b>1004232</b>	
	4000K	1931lm	24°	19	<b>1004238</b>	
		1927lm	36°	16	<b>1004239</b>	
		1872lm	60°	25	<b>1004240</b>	
	2700K	1750lm	24°	16	<b>1004510</b>	
		1744lm	36°	16	<b>1004511</b>	
		1697lm	60°	22	<b>1004512</b>	
	3000K	1804lm	24°	16	<b>1004518</b>	
		1790lm	36°	13	<b>1004519</b>	
		1749lm	60°	22	<b>1004520</b>	
	4000K	1931lm	24°	19	<b>1004526</b>	
		1927lm	36°	16	<b>1004527</b>	
		1872lm	60°	25	<b>1004528</b>	

# NUMINOS® L CL



● Preto

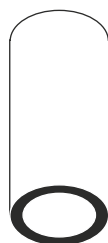
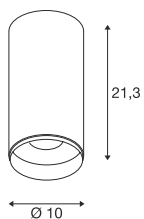

○ Branco



500mA  
220-240V ~50/60Hz  
Potência do sistema: 19W  
Material: alumínio/policarbonato (PC)











versão	EUR
Versões L	146,00
Versões L DALI	198,00

**Nota:**  
Anel decorativo também disponível em branco, dourado e cobre



versão	Art. n.º	EUR
Anel decorativo L		
○ Branco	1006169	2,40
Anel decorativo L		
● Dourado	1008146	10,00
Anel decorativo L		
● Cobre	1008142	10,00



				UGR	Art. N.º	
	2700K	2370lm	24°	19	<b>1004314</b>	
		2245lm	36°	19	<b>1004315</b>	
		2304lm	60°	22	<b>1004316</b>	
	3000K	2432lm	24°	13	<b>1004322</b>	
		2320lm	36°	13	<b>1004323</b>	
		2373lm	60°	22	<b>1004324</b>	
	4000K	2694lm	24°	19	<b>1004330</b>	
		2557lm	36°	19	<b>1004331</b>	
		2601lm	60°	22	<b>1004332</b>	
	2700K	2370lm	24°	19	<b>1004602</b>	
		2245lm	36°	19	<b>1004603</b>	
		2304lm	60°	22	<b>1004604</b>	
	3000K	2432lm	24°	13	<b>1004610</b>	
		2320lm	36°	13	<b>1004611</b>	
		2373lm	60°	22	<b>1004612</b>	
	4000K	2694lm	24°	19	<b>1004618</b>	
		2557lm	36°	19	<b>1004619</b>	
		2601lm	60°	22	<b>1004620</b>	
	2700K	2370lm	24°	19	<b>1004318</b>	
		2245lm	36°	19	<b>1004319</b>	
		2304lm	60°	22	<b>1004320</b>	
	3000K	2432lm	24°	13	<b>1004326</b>	
		2320lm	36°	13	<b>1004327</b>	
		2373lm	60°	22	<b>1004328</b>	
	4000K	2694lm	24°	19	<b>1004334</b>	
		2557lm	36°	19	<b>1004335</b>	
		2601lm	60°	22	<b>1004336</b>	
	2700K	2370lm	24°	19	<b>1004606</b>	
		2245lm	36°	19	<b>1004607</b>	
		2304lm	60°	22	<b>1004608</b>	
	3000K	2432lm	24°	13	<b>1004614</b>	
		2320lm	36°	13	<b>1004615</b>	
		2373lm	60°	22	<b>1004616</b>	
	4000K	2694lm	24°	19	<b>1004622</b>	
		2557lm	36°	19	<b>1004623</b>	
		2601lm	60°	22	<b>1004624</b>	

NUMINOS® XL  
CL



● Preto

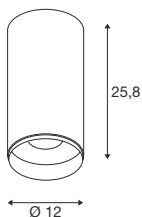

○ Branco



700mA  
220-240V ~50/60Hz  
Potência do sistema: 26W  
Material: alumínio/policarbonato (PC)











versão	EUR
Versões XL	174,00
Versões XL DALI	235,00

**Nota:**  
Anel decorativo também disponível em branco, dourado e cobre



versão	Art. n.º	EUR
Anel decorativo XL		
○ Branco	1006170	3,55
Anel decorativo XL		
● Dourado	1008147	11,00
Anel decorativo XL		
● Cobre	1008143	11,00



				UGR	Art. N.º	
	2700K	3566lm	24°	19	<b>1005687</b>	
		3542lm	36°	19	<b>1005688</b>	
		3152lm	60°	25	<b>1005689</b>	
	3000K	3586lm	24°	19	<b>1005693</b>	
		3536lm	36°	19	<b>1005694</b>	
		3135lm	60°	25	<b>1005695</b>	
	4000K	3891lm	24°	19	<b>1005699</b>	
		3840lm	36°	19	<b>1005700</b>	
		3438lm	60°	25	<b>1005701</b>	
	2700K	3566lm	24°	19	<b>1005759</b>	
		3542lm	36°	19	<b>1005760</b>	
		3152lm	60°	25	<b>1005761</b>	
	3000K	3586lm	24°	19	<b>1005765</b>	
		3536lm	36°	19	<b>1005766</b>	
		3135lm	60°	25	<b>1005767</b>	
	4000K	3891lm	24°	19	<b>1005771</b>	
		3840lm	36°	19	<b>1005772</b>	
		3438lm	60°	25	<b>1005773</b>	
	2700K	3566lm	24°	19	<b>1005690</b>	
		3542lm	36°	19	<b>1005691</b>	
		3152lm	60°	25	<b>1005692</b>	
	3000K	3586lm	24°	19	<b>1005696</b>	
		3536lm	36°	19	<b>1005697</b>	
		3135lm	60°	25	<b>1005698</b>	
	4000K	3891lm	24°	19	<b>1005702</b>	
		3840lm	36°	19	<b>1005703</b>	
		3438lm	60°	25	<b>1005704</b>	
	2700K	3566lm	24°	19	<b>1005762</b>	
		3542lm	36°	19	<b>1005763</b>	
		3152lm	60°	25	<b>1005764</b>	
	3000K	3586lm	24°	19	<b>1005768</b>	
		3536lm	36°	19	<b>1005769</b>	
		3135lm	60°	25	<b>1005770</b>	
	4000K	3891lm	24°	19	<b>1005774</b>	
		3840lm	36°	19	<b>1005775</b>	
		3438lm	60°	25	<b>1005776</b>	

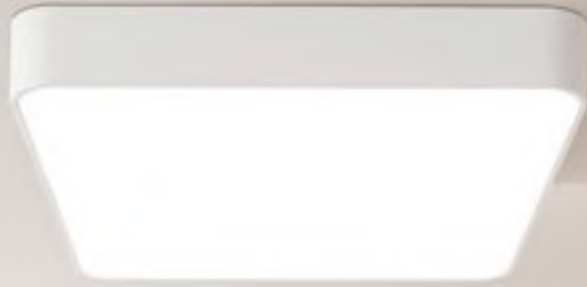



MEDO®  
CL, Quadrado, 1-10V

MEDO®  
CL, Quadrado, DALI

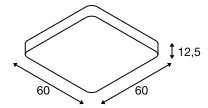
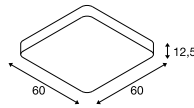

220-240V ~50/60Hz | 1000mA  
Potência do sistema: 39W  
Material: alumínio/acrílico

220-240V ~50/60Hz | 1000mA  
Potência do sistema: 39W  
Material: alumínio/acrílico



Down 3800lm | 3000K

Down 3800lm | 4000K

versão	Art. n.º	EUR
<input type="radio"/> Branco	1000726	499,00

versão	Art. n.º	EUR
<input type="radio"/> Branco	1002882	549,00



Artigo	Art. n.º	EUR
Conjunto de suspensão 1,5 m		
<input type="radio"/> Branco	135251	44,75
Conjunto de suspensão 5 m		
<input type="radio"/> Branco	1001950	99,00



Artigo	Art. n.º	EUR
Conjunto de suspensão 1,5 m		
<input type="radio"/> Branco	135251	44,75
Conjunto de suspensão 5 m		
<input type="radio"/> Branco	1001950	99,00

1002004 193



1002011 193



1002005 193







**TRILEDO**  
CL, single, Quadrado, QPAR51

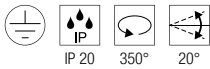
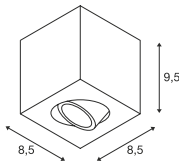

220-240V ~50/60Hz  
Material: alumínio



Casquilho: 1xGU10 máx. Ø: 5,1 cm | C: 5,5 cm

versão	Art. n.º	EUR
● Preto	1002013	73,00
○ Branco	1002015	73,00
● Alumínio	1002004	78,00



LED GU10 51 mm | 6W | 38°  
2700K | 450lm | CEE=F  
6kWh/1000h



Art. N.º: 1005077 | 7,50 EUR

**TRILEDO**  
CL, double, Quadrado, QPAR51

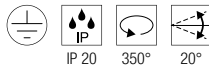
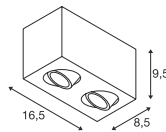

220-240V ~50/60Hz  
Material: alumínio



Casquilho: 2xGU10 máx. Ø: 5,1 cm | C: 5,5 cm

versão	Art. n.º	EUR
● Preto	1002005	107,00
○ Branco	1002006	107,00



LED GU10 51 mm | 6W | 38°  
2700K | 450lm | CEE=F  
6kWh/1000h



Art. N.º: 1005077 | 7,50 EUR

**TRILEDO**  
CL, single, Redondo, QPAR51

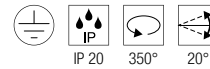
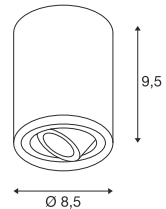

220-240V ~50/60Hz  
Material: alumínio



Casquilho: 1xGU10 máx. Ø: 5,1 cm | C: 5,5 cm

versão	Art. n.º	EUR
● Preto	1002010	73,00
○ Branco	1002011	73,00
● Alumínio	1002012	78,00



LED GU10 51 mm | 6W | 36°  
2200-2700K | 360lm | CEE=G  
6kWh/1000h



Art. N.º: 1005273 | 9,99 EUR





# OCULUS CL, DTW

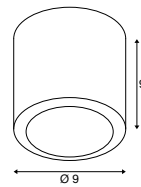

IP20 IK02 100° L80B20

220-240V ~50/60Hz | 250mA

Potência do sistema: 11W

Material: alumínio



Down 36lm | 2000K - 780lm | 3000K

versão	Art. n.º	EUR
● Latão (PVD)	<b>1008619</b>	● <b>285,00</b>
● Cobre escuro (PVD)	<b>1008620</b>	● <b>285,00</b>
● Bronze escuro (PVD)	<b>1008618</b>	● <b>285,00</b>

# OCULUS CL, PHASE

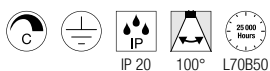
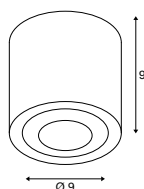

220-240V ~50/60Hz | 250mA  
Potência do sistema: 11W  
Material: alumínio/vidro

- Inclui lente opalina adicional



Down 36lm | 2000K - 780lm | 3000K

versão	Art. n.º	EUR
● Preto	1004666	229,00
○ Branco	1004667	229,00

1004667 196



151811 197





ENOLA B  
CL, QPAR51

ENOLA C  
CL

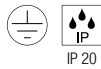
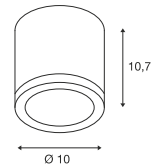
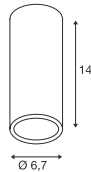

IP 20

220-240V ~50/60Hz  
Material: alumínio

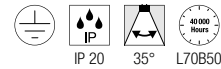

IP 20 35° L70B50

220-240V ~50/60Hz | 500mA  
Potência do sistema: 11W  
Material: alumínio



Casquilho: 1xGU10

Máx. C: 8,5 cm



Down

1020lm | 3000K

versão	Art. n.º	EUR
● Preto	151810	53,00
○ Branco	151811	53,00

versão	Art. n.º	EUR
○ Branco	152101	198,00



LED GU10 51 mm | 6W | 36°  
2200-2700K | 360lm | CEE=G  
6kWh/1000h



Art. N.º: 1005273 | 9,99 EUR



Artigo	Art. n.º	EUR
Anel decorativo		
● Preto	151840	8,95

ASTINA  
CL, QPAR51

1002936 198

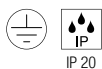
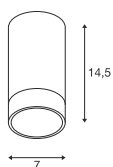

220-240V ~50/60Hz  
Material: alumínio

**SOCKET**  
**INSIDE** <10  
W

Casquilho: 1xGU10

versão	Art. n.º	EUR
● Preto	1002936	88,00
○ Branco	1002934	88,00



LED GU10 51 mm | 6W | 38°  
2700K | 450lm | CEE=F  
6kWh/1000h



Art. N.º: 1005076 | 7,50 EUR





## ANELA CL, PHASE

1000807 199

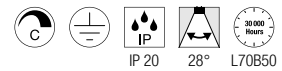
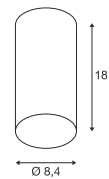

220-240V ~50/60Hz | 500mA  
Potência do sistema: 10W  
Material: alumínio

- Sem refletor



Down 220lm | 3000K | 750lm |

versão	Art. n.º	EUR
● Preto	1000807	156,00



Artigo	Art. n.º	EUR
Refletor 28°		
● Dourado	1000809	19,75

1006439 201







### ASTO TUBE CL, single, GU10

### ASTO TUBE Refletor decorativo



A: 3,95 cm  
 Ø: 6,75 cm  
 Material: policarbonato (PC)

versão	Art. n.º	EUR
● Cromado preto	<b>1007190</b>	<b>4,00</b>
● Dourado	<b>1006450</b>	<b>4,00</b>
● Cromado	<b>1006449</b>	<b>4,00</b>
● Cobre	<b>1006451</b>	<b>4,00</b>

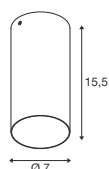

IP 20

220-240V ~50/60Hz  
 Material: alumínio

- Inclui refletor decorativo na cor do produto, feito de plástico reciclado
- Outros refletores decorativos coloridos disponíveis como opção



Casquilho: 1xGU10

versão	Art. n.º	EUR
● Preto	<b>1006439</b>	<b>50,00</b>
○ Branco	<b>1006440</b>	<b>50,00</b>

OCCULDAS 13  
CL, Indireto, PHASE

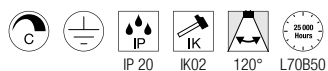
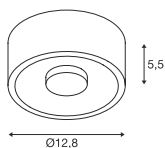

220-240V ~50/60Hz | 350mA  
Potência do sistema: 15W  
Material: alumínio



Down 810lm | 3000K

versão	Art. n.º	EUR
○ Branco	117351	202,00

OCCULDAS 23  
CL, Indireto, PHASE

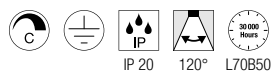
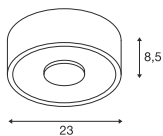

220-240V ~50/60Hz | 700mA  
Potência do sistema: 24W  
Material: alumínio/aço



Down 1500lm | 3000K

versão	Art. n.º	EUR
○ Branco	117321	333,00





ALTRA DICE  
CL, QPAR51

ALTRA DICE  
CW, double, QPAR51

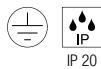
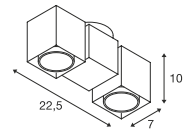
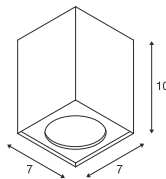

IP 20

220-240V ~50/60Hz  
Material: alumínio/aço

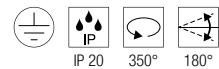

IP 20 350° 180°

220-240V ~50/60Hz  
Material: alumínio/aço

**SOCKET** **INSIDE** <35 W

Casquilho: 1xGU10

versão	Art. n.º	EUR
● Preto	1002216	60,00
○ Branco	151511	60,00

**SOCKET** **INSIDE** <50 W

Casquilho: 2xGU10

versão	Art. n.º	EUR
● Preto	1002215	109,00
○ Branco	151531	109,00



LED GU10 51 mm | 6W | 38°  
2700K | 450lm | CEE=F  
6kWh/1000h



Art. N.º: 1005077 | 7,50 EUR



LED GU10 51 mm | 6W | 36°  
2200-2700K | 360lm | CEE=G



Art. N.º: 1005273 | 9,99 EUR



117101 205

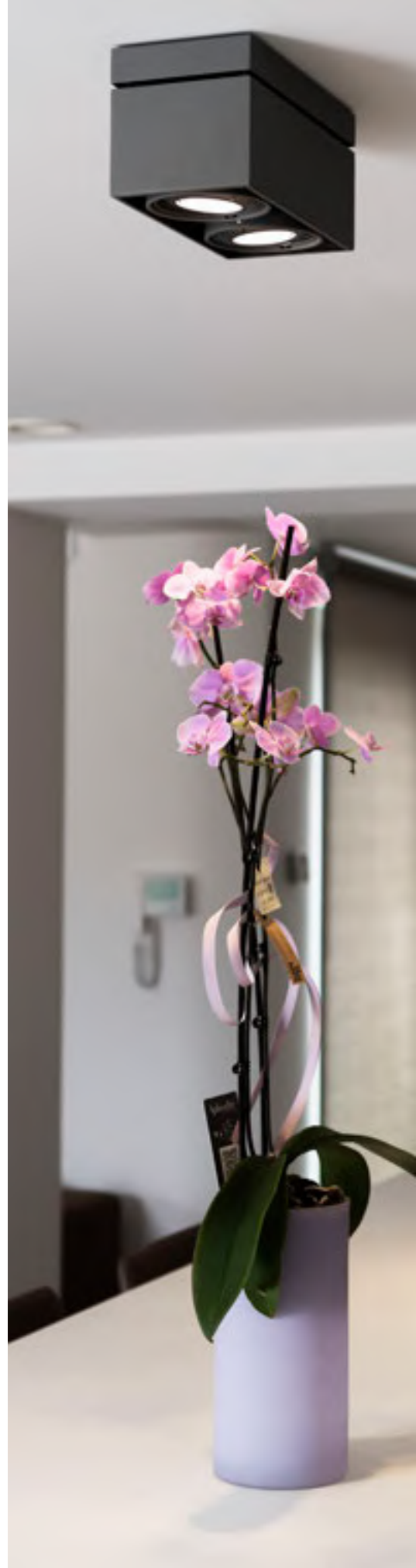



**KARDAMOD**  
CL, single, Quadrado, QPAR111

**KARDAMOD**  
CL, double, Quadrado, QPAR111

117110 205

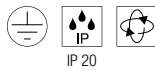
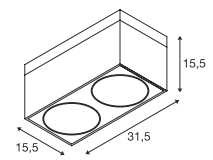
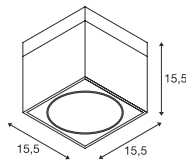

IP 20

220-240V ~50/60Hz  
Material: aço



Casquilho: 1xGU10

versão	Art. n.º	EUR
● Preto	117100	141,00
○ Branco	117101	141,00



QPAR111 | 12W | 55°  
2700K | 670lm | CEE=G  
12kWh/1000h



Art. N.º: 1005297 | 85,00 EUR

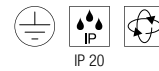

IP 20

220-240V ~50/60Hz  
Material: aço



Casquilho: 2xGU10

versão	Art. n.º	EUR
● Preto	117110	252,00
○ Branco	117111	252,00



LED GU10 | 12,5W | 10°  
3000K | 950lm | CEE=F  
13kWh/1000h



Art. N.º: 1005278 | 55,00 EUR

# FENDA

Roseta para teto, E27

MIX  
match

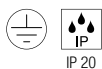
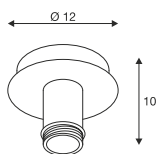

220-240V ~50/60Hz  
Material: aço



Casquilho: 1xE27

versão	Art. n.º	EUR
● Preto	155550	46,75
○ Branco	155551	46,75



LED A60 | 7,5W | 180°  
2700K | 720lm | CEE=F  
8kWh/1000h



Art. N.º: 1005305 | 19,00 EUR

155551 + 156122 206 + 207





**FENDA**  
Ø 30 cm, Redondo

MIX  
match



A: 20 cm  
Ø: 30 cm  
Material: têxtil/aço

versão	Art. n.º	EUR
●● Preto/cobre	155592	70,00
○ Branco	155582	53,00
● Cinzento	1004774	53,00
● Bege	155583	53,00

**FENDA**  
Ø 45 cm, Redondo

MIX  
match



A: 28 cm  
Ø: 45,5 cm  
Material: têxtil/aço

versão	Art. n.º	EUR
●● Preto/cobre	156122	88,00
○ Branco	156111	83,00
● Cinzento	1004775	83,00
● Bege	156113	83,00



Artigo	Art. n.º	EUR
Difusor em vidro acrílico para FENDA Ø 45,5 cm		
○ Branco	156100	44,50

**FENDA**  
Ø 70cm, Redondo

MIX  
match



A: 36 cm  
Ø: 70 cm  
Material: têxtil/aço

versão	Art. n.º	EUR
●● Preto/cobre	1000580	129,00
○ Branco	1000579	112,00



Artigo	Art. n.º	EUR
Difusor em vidro acrílico para FENDA Ø 70 cm		
○ Branco	1000957	94,00



156050 208

## TENORA CL, E27

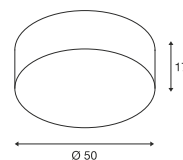

220-240V ~50/60Hz  
Material: aço/têxtil



Casquilho: 3xE27

máx. C: 14,8 cm

versão	Art. n.º	EUR
● Preto	156050	187,00
○ Branco	156051	187,00



LED E27 | 13,2W | 220°  
2700K | 1300lm | CEE=F  
13kWh/1000h



Art. N.º: 1005302 | 12,25 EUR





## SOPRANA CL, E27

155373 209

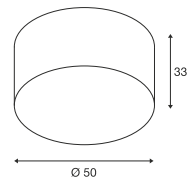

220-240V ~50/60Hz  
Material: aço/têxtil



Casquilho:3xE27

versão	Art. n.º	EUR
● Bege	155373	206,00



A60 | 9W | 220°  
2700K | 800lm | CEE=F  
9kWh/1000h



Art. N.º: 1005301 | 7,35 EUR

148004 210



## PLASTRA CL, QPAR51

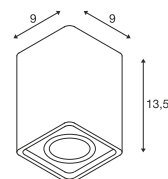

148005 211



IP 20

220-240V ~50/60Hz  
Material: gesso/aço

- Pode ser pintado/forrado individualmente à cor da parede

**SOCKET**  
**INSIDE**

<35  
W

Casquilho: 1xGU10

versão	Art. n.º	EUR
○ Branco	148004	67,00



LED GU10 51 mm | 6W | 38°  
2700K | 450lm | CEE=F  
6kWh/1000h



Art. N.º: 1005077 | 7,50 EUR



### PLASTRA CL, PHASE

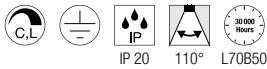
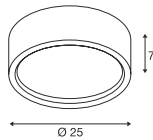

220-240V ~50/60Hz | 350mA  
Potência do sistema: 15W  
Material: gesso/vidro

- Pode ser pintado/forrado individualmente à cor da parede



Down 990lm | 3000K

versão	Art. n.º	EUR
<input type="radio"/> Branco	148005	133,00

### PLASTRA 105 CL, E27

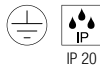
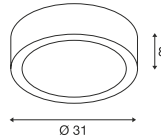

220-240V ~50/60Hz  
Material: gesso/vidro

- Pode ser pintado/forrado individualmente à cor da parede



Casquilho: 2x E27 máx. Ø: 5,1 cm | C: 14 cm

versão	Art. n.º	EUR
<input type="radio"/> Branco	148001	91,00



LED E27 | 8W | 240°  
4000K | 920lm | CEE=E  
8kWh/1000h

Art. N.º: 1005290 | 10,25 EUR



### PLASTRA 104 CL, E27

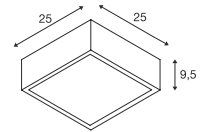

220-240V ~50/60Hz  
Material: gesso/vidro

- Pode ser pintado/forrado individualmente à cor da parede



Casquilho: 2x E27 máx. Ø: 5,1 cm | C: 14 cm

versão	Art. n.º	EUR
<input type="radio"/> Branco	148002	85,00



LED E27 | 8W | 240°  
4000K | 920lm | CEE=E  
8kWh/1000h

Art. N.º: 1005290 | 10,25 EUR



FERA 25  
CL, DALI

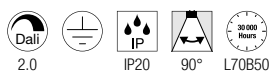
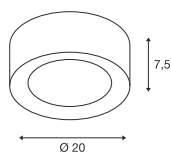

220-240V ~50/60Hz | 500mA  
Potência do sistema: 20W  
Material: policarbonato (PC)



Down 1580lm | 3000K | 1650lm | 4000K

versão	Art. n.º	EUR
● Preto	1002968	272,00
○ Branco	1002967	272,00

FERA 25  
CL

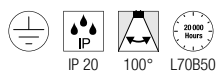
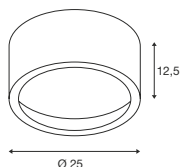

220-240V ~50/60Hz | 550mA  
Potência do sistema: 23W  
Material: alumínio/poliestireno (PS)



Down 1800lm | 3000K

versão	Art. n.º	EUR
● Preto	1001939	201,00
○ Branco	161461	201,00

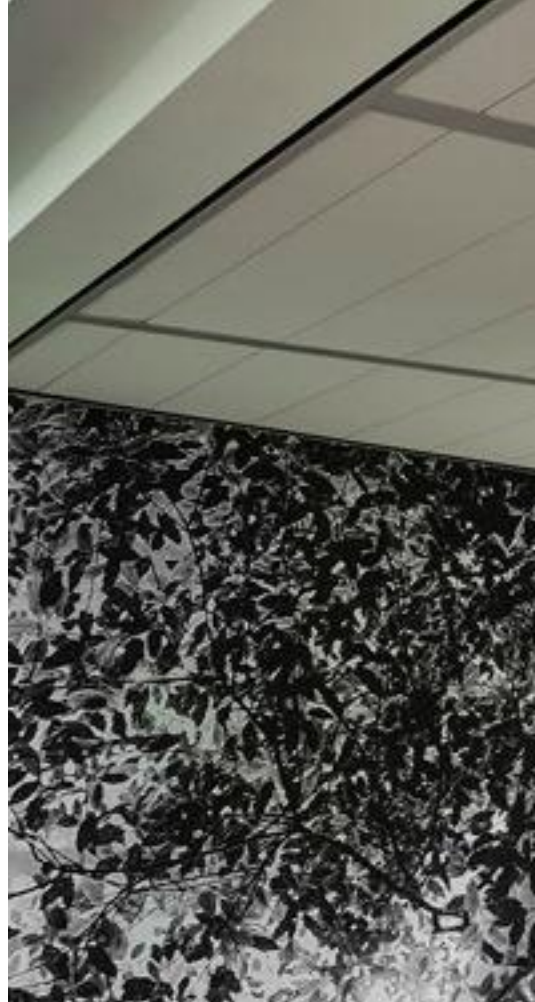



1001939 212

## MARONA CL, PHASE

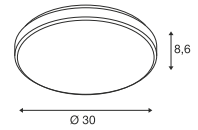

155156 213

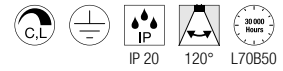

200-240V ~50/60Hz | 430mA  
Potência do sistema: 15W  
Material: polimetilacrilato (PMMA)/aço



Down 1200lm | 3000K

versão	Art. n.º	EUR
● Cinzento	155156	115,00

1000692 215





**Q-LINE®**  
CL, 1m, BAP, PHASE

**Q-LINE®**  
CL, 2m, BAP, PHASE

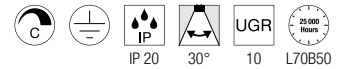
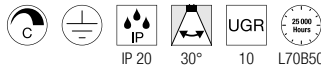
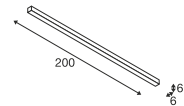
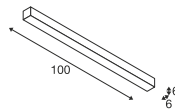

220-240V ~50/60Hz | 900mA  
Potência do sistema: 46W  
Material: alumínio/plástico

220-240V ~50/60Hz | 900mA  
Potência do sistema: 93W  
Material: alumínio/plástico



Down 2100lm | 3000K  
2300lm | 4000K

Down 4200lm | 3000K  
4600lm | 4000K

versão	Art. n.º	EUR
● Preto 2100lm   3000K	<b>1000686</b>	<b>464,00</b>
● Preto 2300lm   4000K	<b>1000689</b>	<b>464,00</b>
○ Branco 2100lm   3000K	<b>1000685</b>	<b>464,00</b>
○ Branco 2300lm   4000K	<b>1000688</b>	<b>464,00</b>

versão	Art. n.º	EUR
● Preto 4200lm   3000K	<b>1000692</b>	<b>696,00</b>
● Preto 4600lm   4000K	<b>1000695</b>	<b>696,00</b>
○ Branco 4200lm   3000K	<b>1000691</b>	<b>696,00</b>
○ Branco 4600lm   4000K	<b>1000694</b>	<b>696,00</b>







PANEL 60  
CL, Redondo, PHASE

PANEL 60  
CL, Redondo, DALI

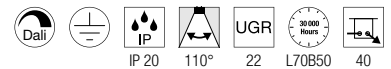
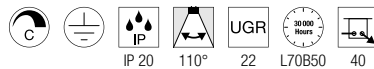
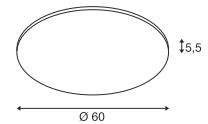
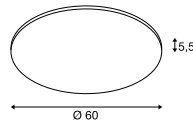

220-240V ~50/60Hz | 1000mA  
Potência do sistema: 42W  
Material: alumínio/polimetilacrilato (PMMA)

120-277V ~50/60Hz | 1000mA  
Potência do sistema: 43W  
Material: alumínio/polimetilacrilato (PMMA)



Down 3150lm | 3000K  
3350lm | 4000K

Down 3150lm | 3000K  
3350lm | 4000K

versão	Art. n.º	EUR
○ Branco 3150lm   3000K	<b>1000783</b>	<b>292,00</b>
○ Branco 3350lm   4000K	<b>1000784</b>	<b>292,00</b>
● Cinzento 3150lm   3000K	<b>1000785</b>	<b>292,00</b>
● Cinzento 3350lm   4000K	<b>1000786</b>	<b>292,00</b>

versão	Art. n.º	EUR
○ Branco 3150lm   3000K	<b>1003040</b>	<b>302,00</b>
○ Branco 3350lm   4000K	<b>1003041</b>	<b>302,00</b>
● Cinzento 3150lm   3000K	<b>1003042</b>	<b>302,00</b>
● Cinzento 3350lm   4000K	<b>1003043</b>	<b>302,00</b>



1008179 285



**LED**  
QUIMERA | 223



**SCKET**  
VARYT | 225



VARYT | 225

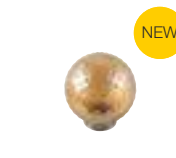

VARYT | 225



VARYT | 225



VARYT | 225



**SCKET**  
WUD | 226



**SCKET**  
WUD | 227



**SCKET**  
WUD | 227



**SCKET**  
WUD | 227



**SCKET**  
SUN 20 | 228



**SCKET**  
SUN 20 | 229



**SCKET**  
MAGICO 20 | 231



**SCKET**  
MAGICO 38 | 231



**SCKET**  
MAGICO 55 | 231



**LED**  
NUMINOS® S | 232



**LED**  
NUMINOS® M | 234



**LED**  
NUMINOS® L | 236



**LED**  
NUMINOS® XL | 238



**LED**  
MEDO® RING 60 | 240, 241



**LED**  
MEDO® RING 90 | 241



**LED**  
MEDO® PRO 30 | 242



**LED**  
MEDO® PRO 40 | 243



**LED**  
MEDO® PRO 60 | 244



**LED**  
MEDO® PRO 90 | 245



**LED**  
MEDO® PRO 30 | 246



**LED**  
MEDO® PRO 40 | 247



**LED**  
MEDO® PRO 60 | 248



**LED**  
MEDO® PRO 90 | 249



**LED**  
MEDO® 30 | 250



**LED**  
MEDO® 40 | 250



**LED**  
MEDO® 60 | 251



**LED**  
MEDO® 90 | 251



**LED**  
MEDO® | 253



**SCKET**  
LALU® | 257



LALU® | 257



LALU® | 258



LALU® | 259



LALU® TETRA 14 | 260



LALU® TETRA 24 | 260



LALU® TETRA 36 | 260



LALU® CONE 15 | 260



LALU®  
PLATE 15 | 260



LALU®  
PLATE 22 | 260



LALU® E  
LYPSE 15 | 261



LALU®  
ELYPSE 22 | 261



LALU®  
ELYPSE 33 | 261



NEW



ONE® FLAT | 265



NEW



ONE® FLAT | 265



NEW



ONE® VERTICAL | 267



ONE® CUBE | 269



ONE® CUBE | 269



ONE® 60 | 271



ONE® 60 | 271



ONE® 60 | 271



ONE® 80 | 273



ONE® 80 | 273



ONE® DOUBLE | 274



ONE® DOUBLE | 274



ONE® TRIPLE | 275



ONE®  
LINEAR 100 | 277



ONE®  
LINEAR 140 | 277



PANTILO  
ROPE 19 | 279



PANTILO  
ROPE 20 | 279



PANTILO  
ROPE 27 | 279



PANTILO OVAL | 281



PANTILO 20 | 281



PANTILO 28 | 281



PANTILO  
CONVEX 29 | 283



PANTILO  
CONVEX 40 | 283



NEW



LIGHT EYE® 90 | 285



NEW



LIGHT EYE® 150 | 285



ASTO TUBE | 287



ASTO TUBE | 287



ASTO TUBE | 287



ASTO TUBE | 287



WORKLIGHT  
PRO 120 | 289



WORKLIGHT  
PRO 150 | 289



WORKLIGHT | 290



PANEL 60 | 291



NOYA | 292



GLENOS | 293









































GLENOS | 293

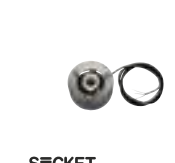

Q-LINE® | 295



			 <span style="background-color: yellow; border-radius: 50%; padding: 2px;">NEW</span>		
<b>LED</b> Q-LINE®   295	<b>LED</b> Q-LINE®   295	<b>LED</b> OCULUS   296	<b>LED</b> OCULUS   297	<b>SCKET</b> FITU   299	<b>SCKET</b> FENDA   300
					
FENDA   300	FENDA   300	FENDA   301	FENDA   301	FENDA   301	<b>LED</b> HELIA AMBIENT 35   304
					
<b>LED</b> HELIA AMBIENT 35   304	<b>LED</b> HELIA 30   305	<b>LED</b> HELIA 30   305	<b>LED</b> HELIA 40   307	<b>LED</b> HELIA 40   307	<b>SCKET</b> ASTINA   309
					
<b>SCKET</b> ENOLA B   309	<b>SCKET</b> ENOLA   309	<b>LED</b> ANELA   310	<b>SCKET</b> TONGA®   311	<b>SCKET</b> QUADRASS   311	<b>SCKET</b> PARA CONE 20   313
					
<b>SCKET</b> PARA CONE 30   313	<b>SCKET</b> PHELIA 10   315	<b>SCKET</b> PHELIA 20   315	<b>SCKET</b> PHELIA 30   315	<b>SCKET</b> FORCHINI 50   316	<b>SCKET</b> FORCHINI 70   316
					
<b>SCKET</b> FORCHINI M 40   317	<b>SCKET</b> FORCHINI M 50   317	<b>SCKET</b> ROTOBALL 25   319	<b>SCKET</b> ROTOBALL 40   319	<b>SCKET</b> ROTOBALL 50   319	<b>SCKET</b> PARA DOME   320
					
PARA DOME   320	PARA DOME   320	<b>SCKET</b> PARA 380   321			

1008033 223





## QUIMERA PD, Phase

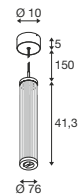

220-240V ~50/60Hz | 700mA

Potência do sistema: 8,2W

Material: alumínio/vidro



Down 310lm | 2700K | 320lm | 3000K

Versão	Art. n.º	EUR
● Latão (PVD)	1008033	● 369,00
● Cobre escuro (PVD)	1008034	● 369,00
● Bronze escuro (PVD)	1008032	● 369,00

1008115 + 1008119 225







## VARYT PD, E14

MIX  
match



NEW

## VARYT Difusor em vidro p/ PD, WL, CL, TL

MIX  
match



NEW



IK02

A: 12,8 cm  
Ø: 12 cm  
Material: vidro

## VARYT Difusor em vidro diamante p/ PD, WL, CL, TL

MIX  
match

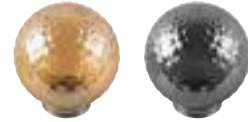

NEW



IK02

A: 12,7 cm  
Ø: 12 cm  
Material: vidro

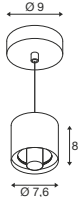

Versão	Art. n.º	EUR
○ Branco	1008119	59,00

Versão	Art. n.º	EUR
● âmbar	1008023	79,00
● fumado	1007858	79,00

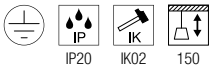

220-240V ~50/60Hz  
Material: alumínio



Casquilho: 1xE14 máx. Ø: 11 cm | C: 3,8 cm

Versão	Art. n.º	EUR
● Preto	1008114	109,00
○ Branco	1008115	109,00
● Latão (PVD)	1008117	139,00
● Cromado	1008116	119,00
● Cobre (PVD)	1008118	139,00



C35 | 4,2W | 320°  
2700K | 350lm | CEE=G  
5kWh/1000h



Art. N.º: 1005285 | 8,50 EUR

## VARYT Difusor em vidro plissado p/ PD, WL, CL, TL

MIX  
match



NEW



IK02

A: 13 cm  
Ø: 12 cm  
Material: vidro

## VARYT Difusor em vidro linha p/ PD, WL, CL, TL

MIX  
match



NEW



IK02

A: 13,5 cm  
Ø: 11,5 cm  
Material: vidro

Versão	Art. n.º	EUR
○ Branco	1007859	69,00

Versão	Art. n.º	EUR
○ Branco	1007860	75,00

WUD  
PD, E27, ballshape

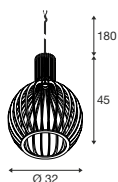

1008044 226

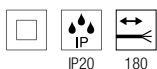

220-240V ~50/60Hz  
Material: madeira

- Extremidade do cabo aberta



Casquilho: 1xE27

Versão	Art. n.º	EUR
● Areia	1008044	175,00



G127 LED | 7,5W | 320°  
2700K | 800lm | CEE=F  
8kWh/1000h



Art. N.º: 1005310 | 18,50 EUR



Artigo	Art. n.º	EUR
Roseta saliente para teto		
● Preto	1004744	34,00
○ Branco	1004745	34,00
● Dourado	1006377	37,25
Roseta para encastrar no teto		
● Preto	132600	26,00
○ Branco	132601	26,00
● Cromado	132605	28,50
● Dourado	1002163	28,50
Adaptador para calha eletrificada monof.		
● Preto	143120	15,00
● Cinzento	143124	15,00
○ Branco	143121	15,00
Adaptador para calha eletrificada trif.		
● Preto	145990	19,70
● Cinzento	145994	19,70
○ Branco	1001542	19,70

1008047 227





WUD  
PD, E27, half round

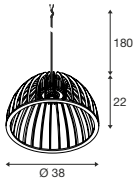

220-240V ~50/60Hz  
Material: madeira

- Extremidade do cabo aberta



Casquilho: 1xE27

Versão	Art. n.º	EUR
● Areia	1008045	175,00



LED Rusika Soft | 6W | 330°  
2200K | 570lm | CEE=F  
6kWh/1000h



Art. N.º: 1008156 | 54,00 EUR



Artigo	Art. n.º	EUR
Roseta saliente para teto		
● Preto	1004744	34,00
○ Branco	1004745	34,00
● Dourado	1006377	37,25
Roseta para encastrar no teto		
● Preto	132600	26,00
○ Branco	132601	26,00
● Cromado	132605	28,50
● Dourado	1002163	28,50
Adaptador para calha eletrificada monof.		
● Preto	143120	15,00
● Cinzento	143124	15,00
○ Branco	143121	15,00
Adaptador para calha eletrificada trif.		
● Preto	145990	19,70
● Cinzento	145994	19,70
○ Branco	1001542	19,70

WUD  
PD, E27, conical



220-240V ~50/60Hz  
Material: madeira

- Extremidade do cabo aberta



Casquilho: 1xE27

Versão	Art. n.º	EUR
● Areia	1008046	150,00



LED Rusika Soft | 6W | 330°  
2200K | 570lm | CEE=F  
6kWh/1000h



Art. N.º: 1008156 | 54,00 EUR



Artigo	Art. n.º	EUR
Roseta saliente para teto		
● Preto	1004744	34,00
○ Branco	1004745	34,00
● Dourado	1006377	37,25
Roseta para encastrar no teto		
● Preto	132600	26,00
○ Branco	132601	26,00
● Cromado	132605	28,50
● Dourado	1002163	28,50
Adaptador para calha eletrificada monof.		
● Preto	143120	15,00
● Cinzento	143124	15,00
○ Branco	143121	15,00
Adaptador para calha eletrificada trif.		
● Preto	145990	19,70
● Cinzento	145994	19,70
○ Branco	1001542	19,70

WUD  
PD, E27, cylindrical

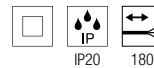
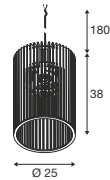

220-240V ~50/60Hz  
Material: madeira

- Extremidade do cabo aberta



Casquilho: 1xE27

Versão	Art. n.º	EUR
● Areia	1008047	145,00



Tubo LED 30 | 6W | 330°  
2200K | 570lm | CEE=F  
6kWh/1000h



Art. N.º: 1008152 | 64,00 EUR



Artigo	Art. n.º	EUR
Roseta saliente para teto		
● Preto	1004744	34,00
○ Branco	1004745	34,00
● Dourado	1006377	37,25
Roseta para encastrar no teto		
● Preto	132600	26,00
○ Branco	132601	26,00
● Cromado	132605	28,50
● Dourado	1002163	28,50
Adaptador para calha eletrificada monof.		
● Preto	143120	15,00
● Cinzento	143124	15,00
○ Branco	143121	15,00
Adaptador para calha eletrificada trif.		
● Preto	145990	19,70
● Cinzento	145994	19,70
○ Branco	1001542	19,70

SUN 20  
PD, E27

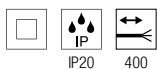
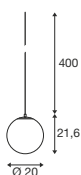

220-240V ~50/60Hz  
Material: alumínio

- Extremidade do cabo aberta



Casquilho: 1xE27 Máx. Ø: 4,5 cm

Versão	Art. n.º	EUR
● Preto	1008139	99,00
● Dourado	1008138	99,00



LED T38 | 8W | 240°  
3000K | 880lm | CEE=E  
8kWh/1000h



Art. N.º: 1005289 | 10,25 EUR



1008139 228

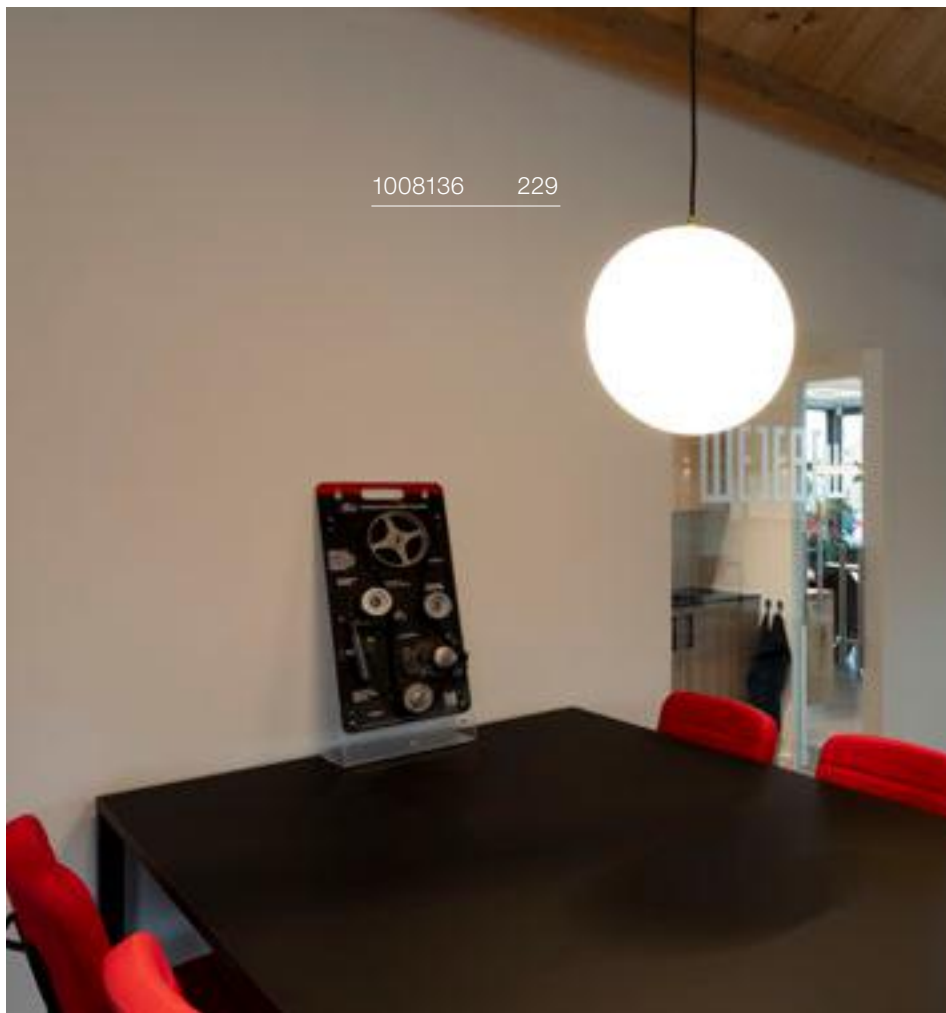

1008136 229



SUN 30  
PD, E27

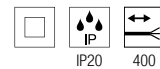
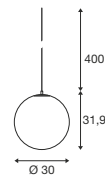

220-240V ~50/60Hz  
Material: alumínio

- Extremidade do cabo aberta

**SOCKET**  
**INSIDE**

<40  
W

Casquilho: 1xE27

Máx. Ø: 4,5 cm

Versão	Art. n.º	EUR
● Preto	1008137	● 149,00
● Dourado	1008136	● 149,00



LED T38 | 8W | 240°  
3000K | 880lm | CEE=E  
8kWh/1000h



Art. N.º: 1005289 | 10,25 EUR



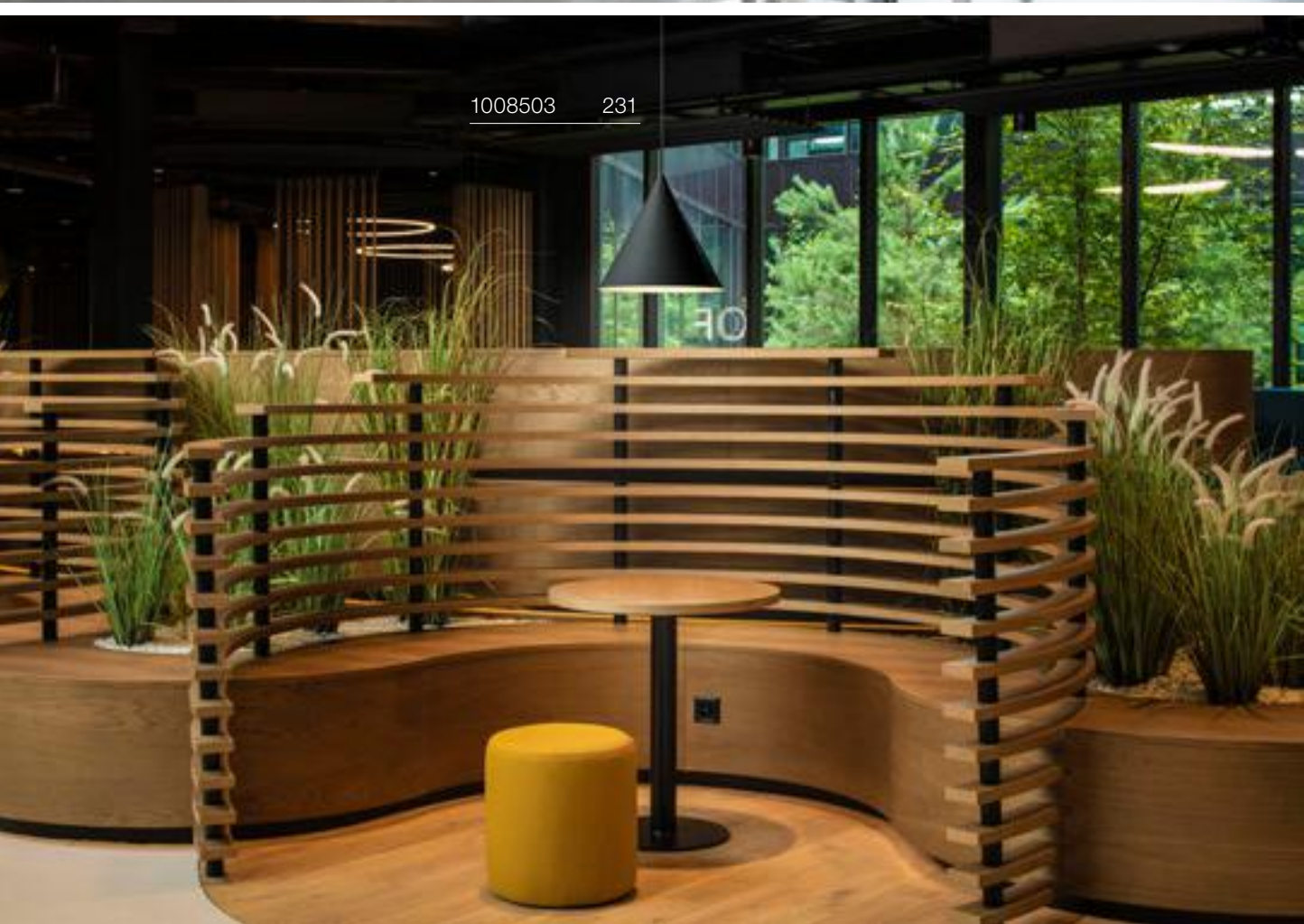



### MAGICO 20 PD, E27

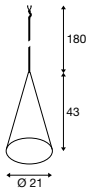

220-240V ~50/60Hz  
Material: alumínio

- Extremidade do cabo aberta



Casquilho: 1xE27

Versão	Art. n.º	EUR
● Preto	1008500	189,00
● Preto/dourado	1008502	189,00
○ Branco	1008501	189,00



LED Tube 30 | 6W | 330°  
2200K | 570lm | CEE=F  
6kWh/1000h



Art. N.º: 1008152 | 64,00 EUR

### MAGICO 38 PD, E27

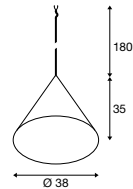

220-240V ~50/60Hz  
Material: alumínio

- Extremidade do cabo aberta



Casquilho: 1xE27

Versão	Art. n.º	EUR
● Preto	1008503	199,00
● Preto/dourado	1008505	199,00
○ Branco	1008504	199,00



mLED Rusika Soft | 6W | 330°  
2200K | 570lm | CEE=F  
6kWh/1000h



Art. N.º: 1008156 | 54,00 EUR

### MAGICO 55 PD, E27

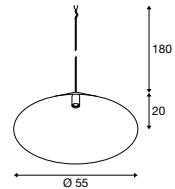

220-240V ~50/60Hz  
Material: alumínio

- Extremidade do cabo aberta



Casquilho: 1xE27

Versão	Art. n.º	EUR
● Preto	1008507	205,00
● Preto/dourado	1008508	205,00
○ Branco	1008506	205,00



E27 fumado cinza | 8W | 330°  
1900K | 400lm  
8kWh/1000h



Art. N.º: 1008159 | 89,00 EUR

# NUMINOS® S PD



● Preto

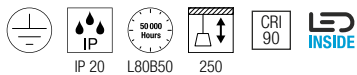
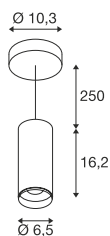

200mA  
220-240V ~50/60Hz  
Potência do sistema: 8,6W  
Material: alumínio/policarbonato (PC)

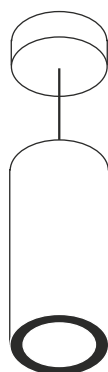

○ Branco

Versão	EUR
Versões S	140,00
Versões S DALI	198,00











**Nota:**  
Anel decorativo também disponível em branco, dourado e cobre



Versão	Art. n.º	EUR
Anel frontal S		
○ Branco	1006167	1,30
Anel frontal S		
● Dourado	1008144	8,00
Anel frontal S		
● Cobre	1008140	8,00





				UGR	Art. N.º	
	2700K	930lm	24°	16	<b>1004146</b>	
		944lm	36°	16	<b>1004147</b>	
		960lm	60°	19	<b>1004148</b>	
	3000K	1016lm	24°	13	<b>1004154</b>	
		1037lm	36°	13	<b>1004155</b>	
		1042lm	60°	19	<b>1004156</b>	
	4000K	1074lm	24°	16	<b>1004162</b>	
		1092lm	36°	16	<b>1004163</b>	
		1098lm	60°	19	<b>1004164</b>	
	2700K	930lm	24°	16	<b>1004434</b>	
		944lm	36°	16	<b>1004435</b>	
		960lm	60°	19	<b>1004436</b>	
	3000K	1016lm	24°	13	<b>1004442</b>	
		1037lm	36°	13	<b>1004443</b>	
		1042lm	60°	19	<b>1004444</b>	
	4000K	1074lm	24°	16	<b>1004450</b>	
		1092lm	36°	16	<b>1004451</b>	
		1098lm	60°	19	<b>1004452</b>	
	2700K	930lm	24°	16	<b>1004150</b>	
		944lm	36°	16	<b>1004151</b>	
		960lm	60°	19	<b>1004152</b>	
	3000K	1016lm	24°	13	<b>1004158</b>	
		1037lm	36°	13	<b>1004159</b>	
		1042lm	60°	19	<b>1004160</b>	
	4000K	1074lm	24°	16	<b>1004166</b>	
		1092lm	36°	16	<b>1004167</b>	
		1098lm	60°	19	<b>1004168</b>	
	2700K	930lm	24°	16	<b>1004438</b>	
		944lm	36°	16	<b>1004439</b>	
		960lm	60°	19	<b>1004440</b>	
	3000K	1016lm	24°	13	<b>1004446</b>	
		1037lm	36°	13	<b>1004447</b>	
		1042lm	60°	19	<b>1004448</b>	
	4000K	1074lm	24°	16	<b>1004454</b>	
		1092lm	36°	16	<b>1004455</b>	
		1098lm	60°	19	<b>1004456</b>	

# NUMINOS® M PD



● Preto

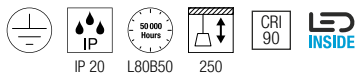
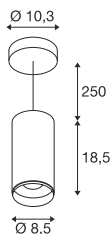

350mA  
220-240V ~50/60Hz  
Potência do sistema: 14W  
Material: alumínio/policarbonato (PC)

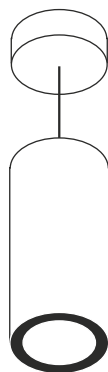

○ Branco











Versão	EUR
Versões M	157,00
Versões M DALI	210,00

**Nota:**  
Anel decorativo também disponível em branco, dourado e cobre



Versão	Art. n.º	EUR
Anel frontal M		
○ Branco	1006167	1,30
Anel frontal M		
● Dourado	1008145	9,00
Anel frontal M		
● Cobre	1008141	9,00



				UGR	Art. N.º	
	2700K	1750lm	24°	16	<b>1004242</b>	
		1744lm	36°	16	<b>1004243</b>	
		1697lm	60°	22	<b>1004244</b>	
	3000K	1804lm	24°	16	<b>1004250</b>	
		1790lm	36°	13	<b>1004251</b>	
		1749lm	60°	22	<b>1004252</b>	
	4000K	1931lm	24°	19	<b>1004258</b>	
		1927lm	36°	16	<b>1004259</b>	
		1872lm	60°	25	<b>1004260</b>	
	2700K	1750lm	24°	16	<b>1004530</b>	
		1744lm	36°	16	<b>1004531</b>	
		1697lm	60°	22	<b>1004532</b>	
	3000K	1804lm	24°	16	<b>1004538</b>	
		1790lm	36°	13	<b>1004539</b>	
		1749lm	60°	22	<b>1004540</b>	
	4000K	1931lm	24°	19	<b>1004546</b>	
		1927lm	36°	16	<b>1004547</b>	
		1872lm	60°	25	<b>1004548</b>	
	2700K	1750lm	24°	16	<b>1004246</b>	
		1744lm	36°	16	<b>1004247</b>	
		1697lm	60°	22	<b>1004248</b>	
	3000K	1804lm	24°	16	<b>1004254</b>	
		1790lm	36°	13	<b>1004255</b>	
		1749lm	60°	22	<b>1004256</b>	
	4000K	1931lm	24°	19	<b>1004262</b>	
		1927lm	36°	16	<b>1004263</b>	
		1872lm	60°	25	<b>1004264</b>	
	2700K	1750lm	24°	16	<b>1004534</b>	
		1744lm	36°	16	<b>1004535</b>	
		1697lm	60°	22	<b>1004536</b>	
	3000K	1804lm	24°	16	<b>1004542</b>	
		1790lm	36°	13	<b>1004543</b>	
		1749lm	60°	22	<b>1004544</b>	
	4000K	1931lm	24°	19	<b>1004550</b>	
		1927lm	36°	16	<b>1004551</b>	
		1872lm	60°	25	<b>1004552</b>	

# NUMINOS® L PD



● Preto

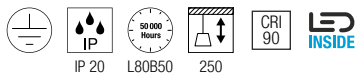
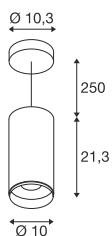

500mA  
220-240V ~50/60Hz  
Potência do sistema: 19W  
Material: alumínio/policarbonato (PC)

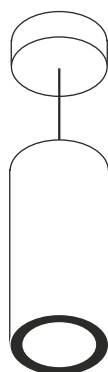

○ Branco











Versão	EUR
Versões L	172,00
Versões L DALI	228,00

**Nota:**  
Anel decorativo também disponível em branco, dourado e cobre



Versão	Art. n.º	EUR
Anel frontal L		
○ Branco	1006169	2,40
Anel frontal L		
● Dourado	1008146	10,00
Anel frontal L		
● Cobre	1008142	10,00



				UGR	Art. N.º	
	2700K	2370lm	24°	19	<b>1004338</b>	
		2245lm	36°	19	<b>1004339</b>	
		2304lm	60°	22	<b>1004340</b>	
	3000K	2432lm	24°	13	<b>1004346</b>	
		2320lm	36°	13	<b>1004347</b>	
		2373lm	60°	22	<b>1004348</b>	
	4000K	2694lm	24°	19	<b>1004354</b>	
		2557lm	36°	19	<b>1004355</b>	
		2601lm	60°	22	<b>1004356</b>	
	2700K	2370lm	24°	19	<b>1004626</b>	
		2245lm	36°	19	<b>1004627</b>	
		2304lm	60°	22	<b>1004628</b>	
	3000K	2432lm	24°	13	<b>1004634</b>	
		2320lm	36°	13	<b>1004635</b>	
		2373lm	60°	22	<b>1004636</b>	
	4000K	2694lm	24°	19	<b>1004642</b>	
		2557lm	36°	19	<b>1004643</b>	
		2601lm	60°	22	<b>1004644</b>	
	2700K	2370lm	24°	19	<b>1004342</b>	
		2245lm	36°	19	<b>1004343</b>	
		2304lm	60°	22	<b>1004344</b>	
	3000K	2432lm	24°	13	<b>1004350</b>	
		2320lm	36°	13	<b>1004351</b>	
		2373lm	60°	22	<b>1004352</b>	
	4000K	2694lm	24°	19	<b>1004358</b>	
		2557lm	36°	19	<b>1004359</b>	
		2601lm	60°	22	<b>1004360</b>	
	2700K	2370lm	24°	19	<b>1004630</b>	
		2245lm	36°	19	<b>1004631</b>	
		2304lm	60°	22	<b>1004632</b>	
	3000K	2432lm	24°	13	<b>1004638</b>	
		2320lm	36°	13	<b>1004639</b>	
		2373lm	60°	22	<b>1004640</b>	
	4000K	2694lm	24°	19	<b>1004646</b>	
		2557lm	36°	19	<b>1004647</b>	
		2601lm	60°	22	<b>1004648</b>	

NUMINOS® XL  
PD



● Preto

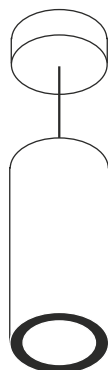
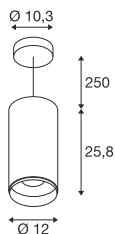

○ Branco

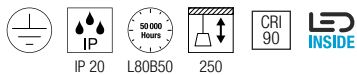

700mA  
220-240V ~50/60Hz  
Potência do sistema: 26W  
Material: alumínio/policarbonato (PC)











Versão	EUR
Versões XL	198,00
Versões XL DALI	254,00

**Nota:**  
Anel decorativo também disponível em branco, dourado e cobre



Versão	Art. n.º	EUR
Anel frontal XL		
○ Branco	1006170	3,55
Anel frontal XL		
● Dourado	1008147	11,00
Anel frontal XL		
● Cobre	1008143	11,00



				UGR	Art. N.º	
	2700K	3566lm	24°	19	<b>1005705</b>	
		3542lm	36°	19	<b>1005706</b>	
		3152lm	60°	25	<b>1005707</b>	
	3000K	3586lm	24°	19	<b>1005711</b>	
		3536lm	36°	19	<b>1005712</b>	
		3135lm	60°	25	<b>1005713</b>	
	4000K	3891lm	24°	19	<b>1005717</b>	
		3840lm	36°	19	<b>1005718</b>	
		3438lm	60°	25	<b>1005719</b>	
	2700K	3566lm	24°	19	<b>1005777</b>	
		3542lm	36°	19	<b>1005778</b>	
		3152lm	60°	25	<b>1005779</b>	
	3000K	3586lm	24°	19	<b>1005783</b>	
		3536lm	36°	19	<b>1005784</b>	
		3135lm	60°	25	<b>1005785</b>	
	4000K	3891lm	24°	19	<b>1005789</b>	
		3840lm	36°	19	<b>1005790</b>	
		3438lm	60°	25	<b>1005791</b>	
	2700K	3566lm	24°	19	<b>1005708</b>	
		3542lm	36°	19	<b>1005709</b>	
		3152lm	60°	25	<b>1005710</b>	
	3000K	3586lm	24°	19	<b>1005714</b>	
		3536lm	36°	19	<b>1005715</b>	
		3135lm	60°	25	<b>1005716</b>	
	4000K	3891lm	24°	19	<b>1005720</b>	
		3840lm	36°	19	<b>1005721</b>	
		3438lm	60°	25	<b>1005722</b>	
	2700K	3566lm	24°	19	<b>1005780</b>	
		3542lm	36°	19	<b>1005781</b>	
		3152lm	60°	25	<b>1005782</b>	
	3000K	3586lm	24°	19	<b>1005786</b>	
		3536lm	36°	19	<b>1005787</b>	
		3135lm	60°	25	<b>1005788</b>	
	4000K	3891lm	24°	19	<b>1005792</b>	
		3840lm	36°	19	<b>1005793</b>	
		3438lm	60°	25	<b>1005794</b>	



1008590 241

## MEDO® RING 60 PD, DALI

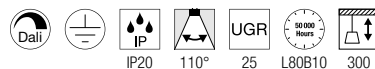
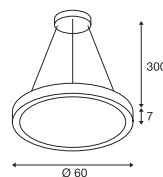

220-240V ~50/60Hz | 700mA  
Potência do sistema: 26W  
Material: alumínio/aço



Down 3750lm | 3000K | 4000lm | 4000K

Versão	Art. n.º	EUR
● Preto	1008589	779,00
○ Branco	1008590	779,00





### MEDO® RING 60 PD, PHASE

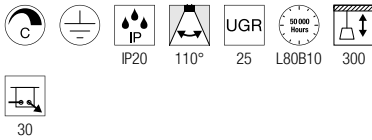
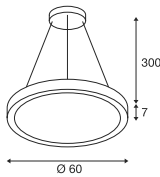

220-240V ~50/60Hz | 700mA  
Potência do sistema: 26W  
Material: alumínio/aço



Down 3750lm | 3000K | 4000lm | 4000K

Versão	Art. n.º	EUR
● Preto	1008591	749,00
○ Branco	1008592	749,00

### MEDO® RING 90 PD, DALI

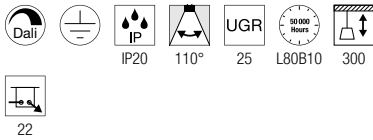
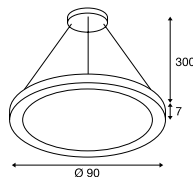

220-240V ~50/60Hz | 1200mA  
Potência do sistema: 42W  
Material: alumínio/aço



Down 5000lm | 3000K | 5300lm | 4000K

Versão	Art. n.º	EUR
● Preto	1008593	975,00
○ Branco	1008594	975,00

### MEDO® RING 90 PD, PHASE

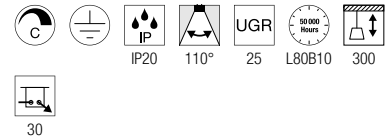
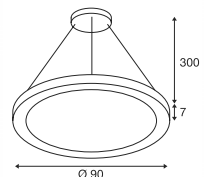

220-240V ~50/60Hz | 1200mA  
Potência do sistema: 43W  
Material: alumínio/aço



Down 5000lm | 3000K | 5300lm | 4000K

Versão	Art. n.º	EUR
● Preto	1008595	939,00
○ Branco	1008596	939,00

MEDO® PRO 30  
CW, DALI, UGR<19

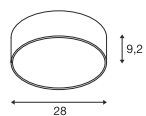

220-240V ~50/60Hz | 250mA  
Potência do sistema: 10W  
Material: alumínio/aço

- Também disponível na Versão DC (a pedido)



Down 1250lm | 3000K | 1250lm | 4000K

Versão	Art. n.º	EUR
● Preto	1007284	329,00
○ Branco	1007285	329,00



Artigo	Art. n.º	EUR
kit de suspensão 1,5 m		
● Preto	135250	44,75
○ Branco	135251	44,75
kit de suspensão 5 m		
● Preto	1001952	99,00
○ Branco	1001950	99,00

MEDO® PRO 30  
CW, PHASE, UGR<19

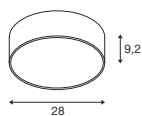

220-240V ~50/60Hz | 250mA  
Potência do sistema: 10W  
Material: alumínio/aço

- Também disponível na Versão DC (a pedido)



Down 1250lm | 3000K | 1250lm | 4000K

Versão	Art. n.º	EUR
● Preto	1007288	299,00
○ Branco	1007289	299,00



Artigo	Art. n.º	EUR
kit de suspensão 1,5 m		
● Preto	135250	44,75
○ Branco	135251	44,75
kit de suspensão 5 m		
● Preto	1001952	99,00
○ Branco	1001950	99,00

1007284

242

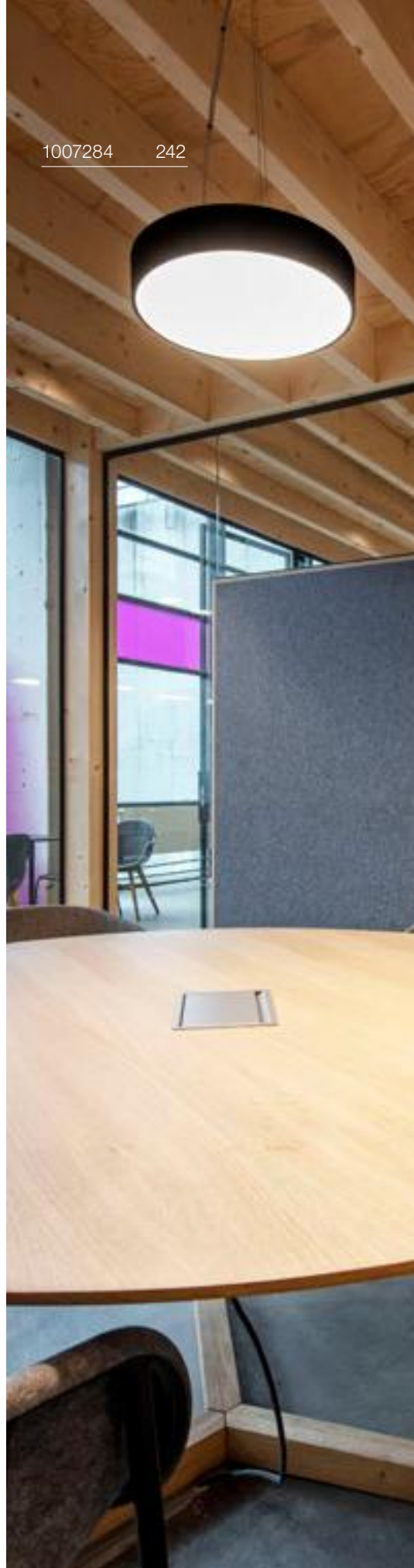



MEDO® PRO 40  
CW, DALI, UGR<19

MEDO® PRO 40  
CW, PHASE, UGR<19

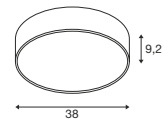
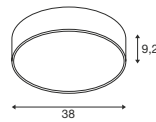

220-240V ~50/60Hz | 500mA  
Potência do sistema: 19W  
Material: alumínio/aço

220-240V ~50/60Hz | 500mA  
Potência do sistema: 19W  
Material: alumínio/aço

- Também disponível na Versão DC (a pedido)

- Também disponível na Versão DC (a pedido)



Down 2400lm | 3000K | 2500lm | 4000K

Down 2400lm | 3000K | 2500lm | 4000K

Versão	Art. n.º	EUR
● Preto	1007292	399,00
○ Branco	1007293	399,00

Versão	Art. n.º	EUR
● Preto	1007296	349,00
○ Branco	1007297	349,00



Artigo	Art. n.º	EUR
kit de suspensão 1,5 m		
● Preto	135250	44,75
○ Branco	135251	44,75
kit de suspensão 5 m		
● Preto	1001952	99,00
○ Branco	1001950	99,00

Artigo	Art. n.º	EUR
kit de suspensão 1,5 m		
● Preto	135250	44,75
○ Branco	135251	44,75
kit de suspensão 5 m		
● Preto	1001952	99,00
○ Branco	1001950	99,00

MEDO® PRO 60  
CW, DALI, UGR<19

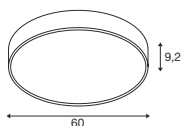

220-240V ~50/60Hz | 1000mA  
Potência do sistema: 39W  
Material: alumínio/aço

- Também disponível na Versão DC (a pedido)



Down 5000lm | 3000K | 5100lm | 4000K

Versão	Art. n.º	EUR
● Preto	1007300	699,00
○ Branco	1007301	699,00



Artigo	Art. n.º	EUR
kit de suspensão 1,5 m		
● Preto	135250	44,75
○ Branco	135251	44,75
kit de suspensão 5 m		
● Preto	1001952	99,00
○ Branco	1001950	99,00

MEDO® PRO 60  
CW, PHASE, UGR<19

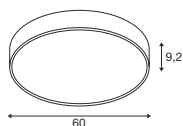

220-240V ~50/60Hz | 1000mA  
Potência do sistema: 37W  
Material: alumínio/aço

- Também disponível na Versão DC (a pedido)



Down 5000lm | 3000K | 5100lm | 4000K

Versão	Art. n.º	EUR
● Preto	1007304	629,00
○ Branco	1007305	629,00



Artigo	Art. n.º	EUR
kit de suspensão 1,5 m		
● Preto	135250	44,75
○ Branco	135251	44,75
kit de suspensão 5 m		
● Preto	1001952	99,00
○ Branco	1001950	99,00

1007304 244

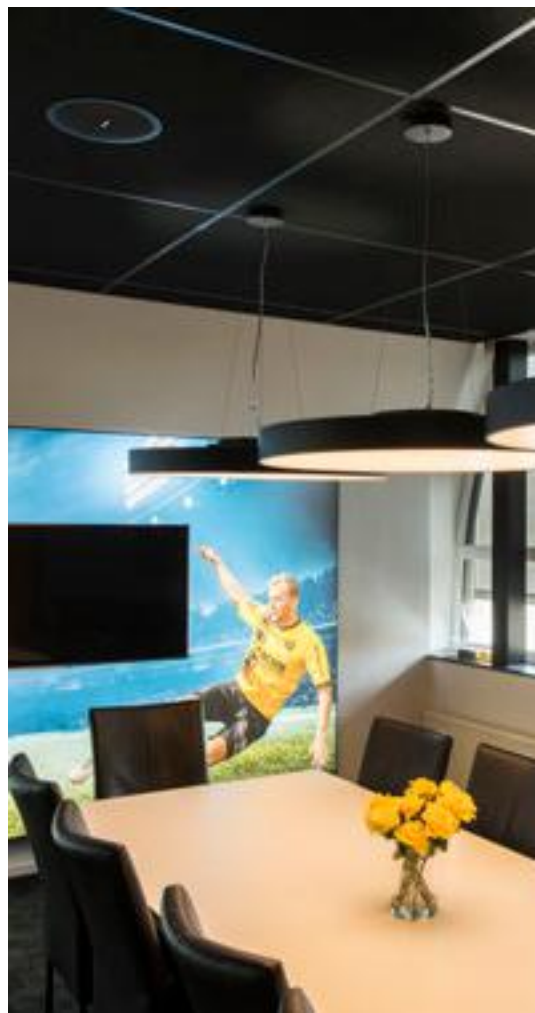



MEDO® PRO 90  
CW, DALI, UGR<19

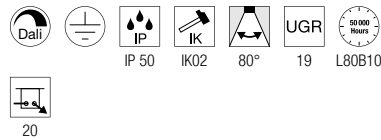

220-240V ~50/60Hz | 1000mA  
Potência do sistema: 75W  
Material: alumínio/aço

- Também disponível na Versão DC (a pedido)



Down 9400lm | 3000K | 9700lm | 4000K

Versão	Art. n.º	EUR
● Preto	1007308	1.399,00
○ Branco	1007309	1.399,00



Artigo	Art. n.º	EUR
kit de suspensão 1,5 m		
● Preto	135250	44,75
○ Branco	135251	44,75
kit de suspensão 5 m		
● Preto	1001952	99,00
○ Branco	1001950	99,00

MEDO® PRO 90  
CW, PHASE, UGR<19

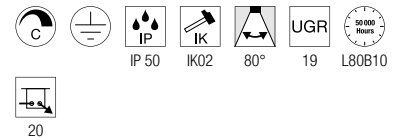

220-240V ~50/60Hz | 1000mA  
Potência do sistema: 74W  
Material: alumínio/aço

- Também disponível na Versão DC (a pedido)



Down 9400lm | 3000K | 9700lm | 4000K

Versão	Art. n.º	EUR
● Preto	1007312	1.249,00
○ Branco	1007313	1.249,00



Artigo	Art. n.º	EUR
kit de suspensão 1,5 m		
● Preto	135250	44,75
○ Branco	135251	44,75
kit de suspensão 5 m		
● Preto	1001952	99,00
○ Branco	1001950	99,00

MEDO® PRO 30  
CW, DALI

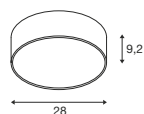

220-240V ~50/60Hz | 250mA  
Potência do sistema: 10W  
Material: alumínio/aço

- Também disponível na Versão DC (a pedido)



Down 1350lm | 3000K | 1350lm | 4000K

Versão	Art. n.º	EUR
● Preto	1007286	319,00
○ Branco	1007287	319,00



Artigo	Art. n.º	EUR
kit de suspensão 1,5 m		
● Preto	135250	44,75
○ Branco	135251	44,75
kit de suspensão 5 m		
● Preto	1001952	99,00
○ Branco	1001950	99,00

MEDO® PRO 30  
CW, PHASE

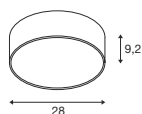

220-240V ~50/60Hz | 250mA  
Potência do sistema: 10W  
Material: alumínio/aço

- Também disponível na Versão DC (a pedido)



Down 1350lm | 3000K | 1350lm | 4000K

Versão	Art. n.º	EUR
● Preto	1007290	289,00
○ Branco	1007291	289,00



Artigo	Art. n.º	EUR
kit de suspensão 1,5 m		
● Preto	135250	44,75
○ Branco	135251	44,75
kit de suspensão 5 m		
● Preto	1001952	99,00
○ Branco	1001950	99,00





1007294 247

## MEDO® PRO 40 CW, DALI

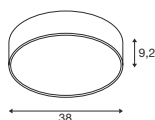

220-240V ~50/60Hz | 500mA  
Potência do sistema: 19W  
Material: alumínio/aço

- Também disponível na Versão DC (a pedido)



Down 2650lm | 3000K | 2650lm | 4000K

Versão	Art. n.º	EUR
● Preto	1007294	389,00
○ Branco	1007295	389,00



Artigo	Art. n.º	EUR
kit de suspensão 1,5 m		
● Preto	135250	44,75
○ Branco	135251	44,75
kit de suspensão 5 m		
● Preto	1001952	99,00
○ Branco	1001950	99,00



## MEDO® PRO 40 CW, PHASE

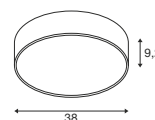

220-240V ~50/60Hz | 500mA  
Potência do sistema: 19W  
Material: alumínio/aço

- Também disponível na Versão DC (a pedido)



Down 2650lm | 3000K | 2650lm | 4000K

Versão	Art. n.º	EUR
● Preto	1007298	339,00
○ Branco	1007299	339,00



Artigo	Art. n.º	EUR
kit de suspensão 1,5 m		
● Preto	135250	44,75
○ Branco	135251	44,75
kit de suspensão 5 m		
● Preto	1001952	99,00
○ Branco	1001950	99,00

MEDO® PRO 60  
CW, DALI

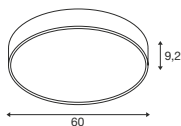

220-240V ~50/60Hz | 1000mA  
Potência do sistema: 39W  
Material: alumínio/aço

- Também disponível na Versão DC (a pedido)



Down 5450lm | 3000K | 5500lm | 4000K

Versão	Art. n.º	EUR
● Preto	1007302	679,00
○ Branco	1007303	679,00



Artigo	Art. n.º	EUR
kit de suspensão 1,5 m		
● Preto	135250	44,75
○ Branco	135251	44,75
kit de suspensão 5 m		
● Preto	1001952	99,00
○ Branco	1001950	99,00

MEDO® PRO 60  
CW, PHASE

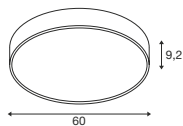

220-240V ~50/60Hz | 1000mA  
Potência do sistema: 37W  
Material: alumínio/aço

- Também disponível na Versão DC (a pedido)



Down 5450lm | 3000K | 5500lm | 4000K

Versão	Art. n.º	EUR
● Preto	1007306	609,00
○ Branco	1007307	609,00



Artigo	Art. n.º	EUR
kit de suspensão 1,5 m		
● Preto	135250	44,75
○ Branco	135251	44,75
kit de suspensão 5 m		
● Preto	1001952	99,00
○ Branco	1001950	99,00

1007303 248







### MEDO® PRO 90 CW, DALI

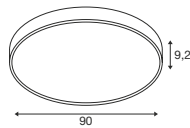

220-240V ~50/60Hz | 1000mA  
Potência do sistema: 75W  
Material: alumínio/aço

- Também disponível na Versão DC (a pedido)



Down 11000lm | 3000K | 11200lm | 4000K

Versão	Art. n.º	EUR
● Preto	1007310	1.379,00
○ Branco	1007311	1.379,00



Artigo	Art. n.º	EUR
kit de suspensão 1,5 m		
● Preto	135250	44,75
○ Branco	135251	44,75
kit de suspensão 5 m		
● Preto	1001952	99,00
○ Branco	1001950	99,00

### MEDO® PRO 90 CW, PHASE

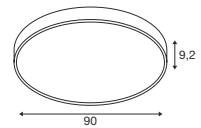

220-240V ~50/60Hz | 1000mA  
Potência do sistema: 74W  
Material: alumínio/aço

- Também disponível na Versão DC (a pedido)



Down 11000lm | 3000K | 11200lm | 4000K

Versão	Art. n.º	EUR
● Preto	1007314	1.229,00
○ Branco	1007315	1.229,00



Artigo	Art. n.º	EUR
kit de suspensão 1,5 m		
● Preto	135250	44,75
○ Branco	135251	44,75
kit de suspensão 5 m		
● Preto	1001952	99,00
○ Branco	1001950	99,00

MEDO® 30  
CW, PHASE

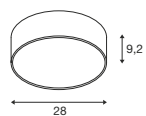
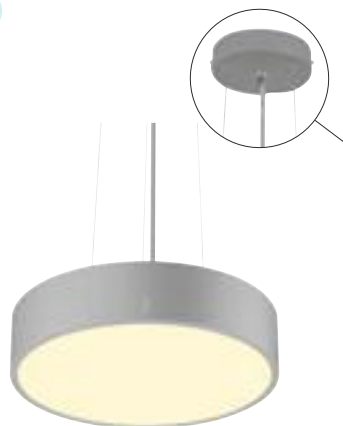

220-240V ~50/60Hz | 250mA  
Potência do sistema: 12W  
Material: alumínio/aço



1000lm | 2700K | 1050lm | 3000K | 1150lm | 4000K

Versão	Art. n.º	EUR
● Preto	1007316	249,00
○ Branco	1007317	249,00
● Cinzento	1007318	249,00



Artigo	Art. n.º	EUR
kit de suspensão 1,5 m		
● Preto	135250	44,75
○ Branco	135251	44,75
● Cinzento	135254	44,75
kit de suspensão 5 m		
● Preto	1001952	99,00
○ Branco	1001950	99,00
● Cinzento	1001951	99,00

MEDO® 40  
CW, PHASE

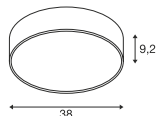

220-240V ~50/60Hz | 500mA  
Potência do sistema: 20W  
Material: alumínio/aço



2000lm | 2700K | 2100lm | 3000K | 2250lm | 4000K

Versão	Art. n.º	EUR
● Preto	1007319	279,00
○ Branco	1007320	279,00
● Cinzento	1007321	279,00



Artigo	Art. n.º	EUR
kit de suspensão 1,5 m		
● Preto	135250	44,75
○ Branco	135251	44,75
● Cinzento	135254	44,75
kit de suspensão 5 m		
● Preto	1001952	99,00
○ Branco	1001950	99,00
● Cinzento	1001951	99,00

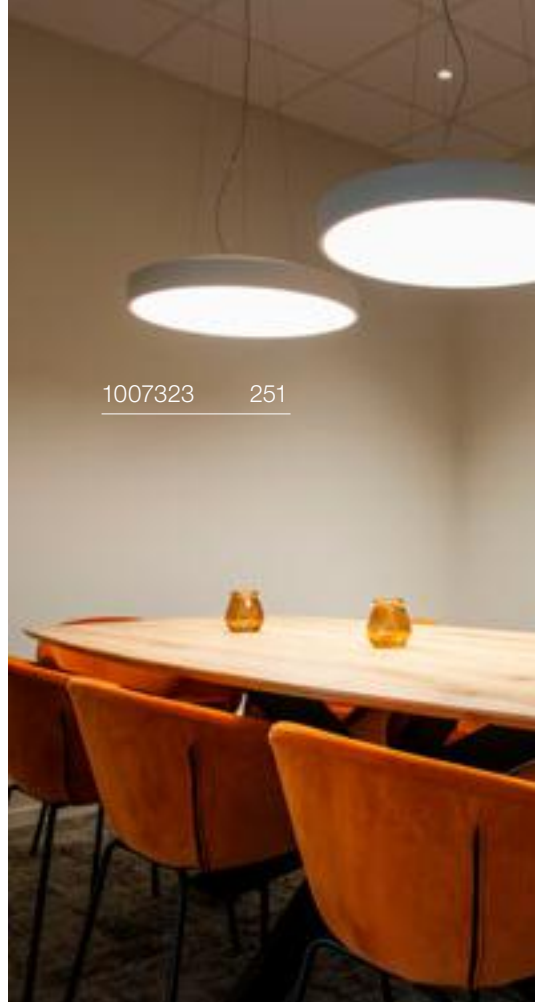

1007323 251





### MEDO® 60 CW, PHASE

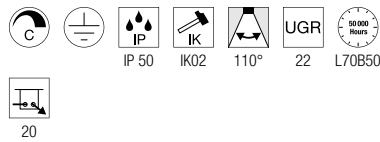
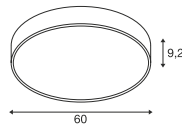

220-240V ~50/60Hz | 1000mA  
Potência do sistema: 39W  
Material: alumínio/aço

**LED INSIDE** IRC 90  
3850lm | 2700K | 4050lm | 3000K | 4300lm | 4000K

Versão	Art. n.º	EUR
● Preto	1007322	529,00
○ Branco	1007323	529,00
● Cinzento	1007324	529,00

Artigo	Art. n.º	EUR
kit de suspensão 1,5 m		
● Preto	135250	44,75
○ Branco	135251	44,75
● Cinzento	135254	44,75
kit de suspensão 5 m		
● Preto	1001952	99,00
○ Branco	1001950	99,00
● Cinzento	1001951	99,00

### MEDO® 90 CW, PHASE

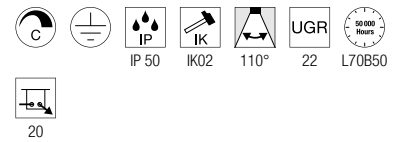
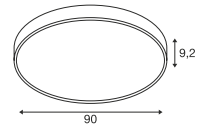

220-240V ~50/60Hz | 1000mA  
Potência do sistema: 79W  
Material: alumínio/aço

**LED INSIDE** IRC 90  
8000lm | 2700K | 8400lm | 3000K | 9000lm | 4000K

Versão	Art. n.º	EUR
● Preto	1007325	1.049,00
○ Branco	1007326	1.049,00
● Cinzento	1007327	1.049,00

Artigo	Art. n.º	EUR
kit de suspensão 1,5 m		
● Preto	135250	44,75
○ Branco	135251	44,75
● Cinzento	135254	44,75
kit de suspensão 5 m		
● Preto	1001952	99,00
○ Branco	1001950	99,00
● Cinzento	1001951	99,00



1000726 253



MEDO®  
CL, Quadrado, 1-10V

MEDO®  
CL, Quadrado, DALI

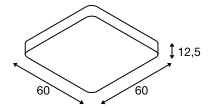
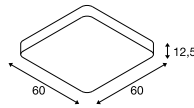

220-240V ~50/60Hz | 1000mA  
Potência do sistema: 39W  
Material: alumínio/acrílico

220-240V ~50/60Hz | 1000mA  
Potência do sistema: 39W  
Material: alumínio/acrílico



Down 3800lm | 3000K



Down 3800 | 4000K

Versão	Art. n.º	EUR
<input type="radio"/> Branco	1000726	499,00

Versão	Art. n.º	EUR
<input type="radio"/> Branco	1002882	549,00



Artigo	Art. n.º	EUR
kit de suspensão 1,5 m		
<input type="radio"/> Branco	135251	44,75
kit de suspensão 5 m		
<input type="radio"/> Branco	1001950	99,00



Artigo	Art. n.º	EUR
kit de suspensão 1,5 m		
<input type="radio"/> Branco	135251	44,75
kit de suspensão 5 m		
<input type="radio"/> Branco	1001950	99,00

# MEDO®

## VISÃO GERAL

---

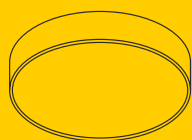

**MEDO®**  
CW

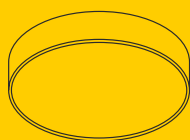

**MEDO® PRO**  
CW

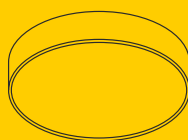

**MEDO® PRO**  
CW



**MEDO®**  
CL, QUADRADO

Tamanhos	<b>30   40   60   90</b>	<b>30   40   60   90</b>	<b>30   40   60   90</b>	<b>60</b>
UGR	22   25	19   25	19   25	22
Unidade de controlo	Phase	Phase	DALI 2	1-10V   DALI 2
DC	-	-	✓	-
CCT Switch	2700K   3000K   4000K	3000K   4000K	3000K   4000K	-
EasyBase	✓	✓	✓	-
Promoção da BEG	-	✓	✓	-
kit de suspensão	1,5   5 m (excl.)	1,5   5 m (excl.)	1,5   5 m (excl.)	1,5   5 m (excl.)

- Instalação mais rápida graças ao EasyBase
- Eficiência elegível a partir de 120lm/W
- Também adequado para locais de trabalho exigentes (por exemplo, escritórios e salas de aula) graças à ótica prismática

Os controladores LED (driver) não estão incluídos e estão disponíveis em separado

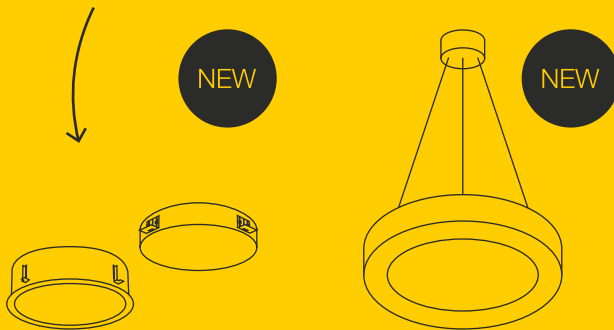

**MEDO®**  
RL, SEM MOLDURA | CAIXA DE MONTAGEM PARA ENCASTRAR

**MEDO® RING**  
PD

**30 | 40 | 60 | 90**

**60 | 90**

19

25

\*

Phase | DALI 2

\*

- | ✓

3000K | 4000K

3000K | 4000K

-

-

✓

✓

-

3 m (incl.)

\*Dependente de controlador



## LUMINÁRIAS DE TETO



Aparafuse o EasyBase ao teto

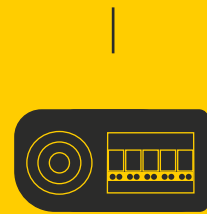

Ligue o EasyBase

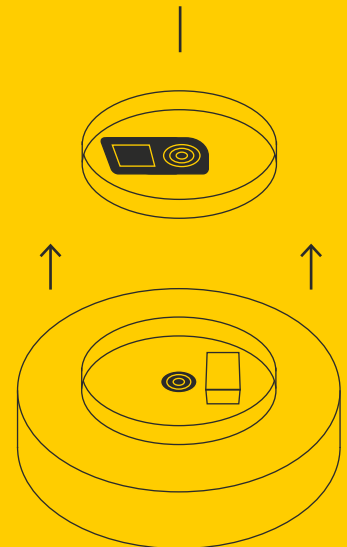

Selecione a temperatura de cor através do interruptor CCT e encaixe a luminária, tendo em atenção as marcações verdes

MEDO® 60 e MEDO® Os 90 são fixados adicionalmente com a corrente de segurança existente



10007658 + 10007660 257





LALU®  
PD, E27

MIX  
match

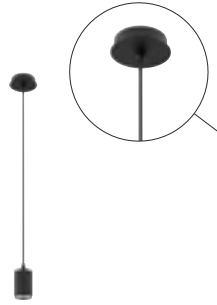

LALU®  
Abajur, E27 Base, Mix&Match

MIX  
match



A: 3,5 cm  
Ø: 33 cm  
Material: alumínio

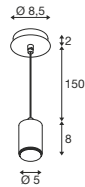

Versão	Art. n.º	EUR
● Preto/bronze	1007659	85,00
● Bronze	1007660	89,00

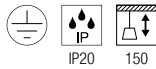

220-240V ~50/60Hz  
Material: alumínio



Casquilho: 1xE27

Versão	Art. n.º	EUR
● Preto	1007658	89,00



A60 | 7,5W | 180°  
2700K | 720lm | CEE=F  
8kWh/1000h



Art. N.º: 1005305 | 19,00 EUR

LALU®  
PD, LED Base, Mix&Match

MIX  
match

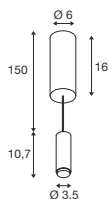
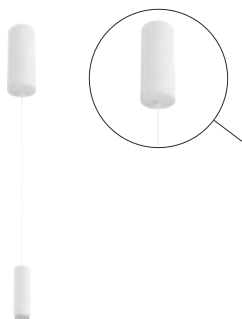

220-240V ~50/60Hz | 500mA  
Potência do sistema: 9,5W  
Material: alumínio

- Encontra os acessórios correspondentes nas páginas 260-261



Down 680lm | 3000K

Versão	Art. n.º	EUR
● Preto	1007518	169,00
○ Branco	1007519	169,00
● Bronze	1007520	175,00

1007550 + 10007541 259 + 261





## LALU® PD, LED Base, Mix&Match

MIX  
match

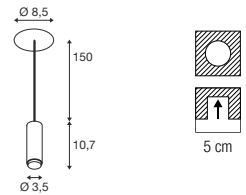
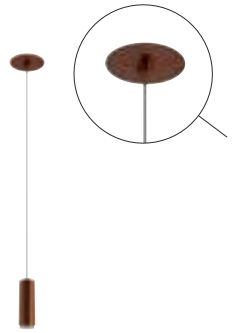

220-240V ~50/60Hz | 500mA

Potência do sistema: 9,5W

Material: alumínio

- Espessura do material da área de instalação: máx. 12 mm
- Encontra os acessórios correspondentes nas páginas 260-261



Down

680lm | 3000K

Versão	Art. n.º	EUR
● Preto	1007548	149,00
○ Branco	1007549	149,00
● Bronze	1007550	155,00

LALU® TETRA 14  
Abajur, Mix&Match

MIX  
match



A: 4,9 cm  
Ø: 14 cm  
Material: aço

Versão	Art. n.º	EUR
● Preto/bronze	1007523	55,00
○ Branco/dourado	1007522	55,00
● Bronze	1007521	58,00

LALU® TETRA 24  
Abajur, Mix&Match

MIX  
match



A: 6,7 cm  
Ø: 24 cm  
Material: aço

Versão	Art. n.º	EUR
● Preto/bronze	1007526	72,00
○ Branco/dourado	1007525	72,00
● Bronze	1007524	78,00

LALU® TETRA 36  
Abajur, Mix&Match

MIX  
match



A: 8,9 cm  
Ø: 36 cm  
Material: aço

- Não pode ser combinada com a base LALU® PD LED de 48 V

Versão	Art. n.º	EUR
● Preto/bronze	1007529	114,00
○ Branco/dourado	1007528	114,00
● Bronze	1007527	126,00

LALU® CONE 15  
Abajur, Mix&Match

MIX  
match



A: 17 cm  
Ø: 15,2 cm  
Material: aço

Versão	Art. n.º	EUR
● Preto/bronze	1007532	57,00
○ Branco/dourado	1007531	57,00
● Bronze	1007530	65,00

LALU® PLATE 15  
Abajur, Mix&Match

MIX  
match



A: 1,5 cm  
Ø: 15 cm  
Material: aço

Versão	Art. n.º	EUR
● Preto/bronze	1007544	42,00
○ Branco/dourado	1007543	42,00
● Bronze	1007542	45,00

LALU® PLATE 22  
Abajur, Mix&Match

MIX  
match



A: 1,5 cm  
Ø: 22 cm  
Material: aço

Versão	Art. n.º	EUR
● Preto/bronze	1007547	55,00
○ Branco/dourado	1007546	55,00
● Bronze	1007545	59,00



LALU® ELYPSE 15  
Abajur, Mix&Match

MIX  
match



A: 1,4 cm  
Ø: 15 cm  
Material: aço

LALU® ELYPSE 22  
Abajur, Mix&Match

MIX  
match



A: 2,8 cm  
Ø: 22 cm  
Material: aço

LALU® ELYPSE 33  
Abajur, Mix&Match

MIX  
match



A: 3,5 cm  
Ø: 33 cm  
Material: aço

- Não pode ser combinada com a base LALU® PD LED de 48 V

Versão	Art. n.º	EUR
● Preto/bronze	<b>1007535</b>	<b>36,00</b>
○ Branco/dourado	<b>1007534</b>	<b>36,00</b>
● Bronze	<b>1007533</b>	<b>42,00</b>

Versão	Art. n.º	EUR
● Preto/bronze	<b>1007538</b>	<b>57,00</b>
○ Branco/dourado	<b>1007537</b>	<b>57,00</b>
● Bronze	<b>1007536</b>	<b>65,00</b>

Versão	Art. n.º	EUR
● Preto/bronze	<b>1007541</b>	<b>89,00</b>
○ Branco/dourado	<b>1007540</b>	<b>89,00</b>
● Bronze	<b>1007539</b>	<b>95,00</b>

# MIX & MATCH

## LALU®

### LALU®

PD, LED BASE, PHASE

Preto	1007518
Branco	1007519
Bronze antigo	1007520



### LALU®

PD, LED BASE, PHASE, RECESSED

Preto	1007548
Branco	1007549
Bronze antigo	1007550



### LALU® TETRA 14

Preto	1007523
Branco	1007522
Bronze antigo	1007521

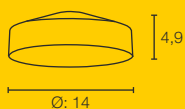

### LALU® CONE 15

Preto	1007532
Branco	1007531
Bronze antigo	1007530

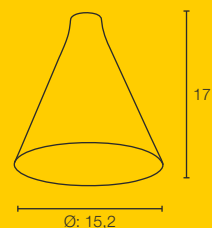

### LALU® TETRA 24

Preto	1007526
Branco	1007525
Bronze antigo	1007524

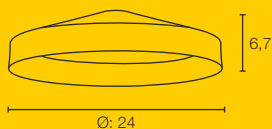

### LALU® TETRA 36

Preto	1007529
Branco	1007528
Bronze antigo	1007527

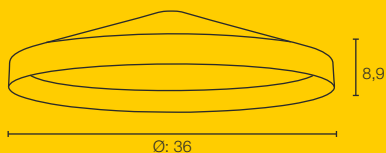

## LALU®

PD, LED BASE, 48V, DALI

Preto		1007749
Branco		1007748
Bronze antigo		1007747



Não compatível com:  
LALU® Elypse 33 e  
LALU® Tetra 36

### LALU® ELYPSE 15

Preto		1007535
Branco		1007534
Bronze antigo		1007533



### LALU® PLATE 15

Preto		1007544
Branco		1007543
Bronze antigo		1007542

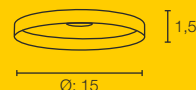

### LALU® ELYPSE 22

Preto		1007538
Branco		1007537
Bronze antigo		1007536



### LALU® PLATE 22

Preto		1007547
Branco		1007546
Bronze antigo		1007545

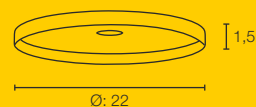

### LALU® ELYPSE 33

Preto		1007541
Branco		1007540
Bronze antigo		1007539



Combine os produtos da gama LALU® de acordo com as suas preferências. Perfeitamente coordenadas, pode combinar formatos, tamanhos e cores ou criar uma composição de várias luminárias. Seja criativo – Identifique os produtos SLV Mix & Match pelo símbolo seguinte:



**MIX**  
match

1007703 265







### ONE® FLAT PD, DALI, triple

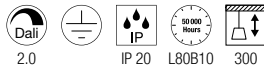
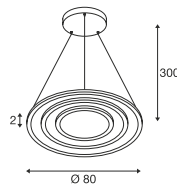

220-240V ~50/60Hz | 1700mA  
Potência do sistema: 58W  
Material: alumínio/aço



Down 3500lm | 2700K | 3700lm | 3000K

Versão	Art. n.º	EUR
● Preto	1007701	1.150,00
● Preto/latão	1007703	1.150,00
○ Branco	1007702	1.150,00

### ONE® FLAT PD, PHASE, single

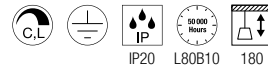
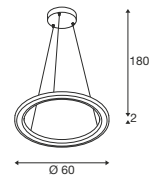

220-240V ~50/60Hz | 600mA  
Potência do sistema: 23W  
Material: alumínio/aço



Down 1300lm | 2700K | 1350lm | 3000K  
1700lm | 1900lm | 1750lm | 2050lm

Versão	Art. n.º	EUR
● Preto		
1300/1350lm	1007855	485,00
● Preto/latão		
1700/1750lm	1007857	485,00
○ Branco		
1900/2050lm	1007856	485,00

1008003 267





# ONE® VERTICAL PD, PHASE

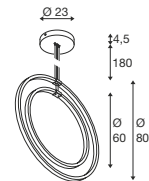

IP 20 L80B10 330° 180

220-240V ~50/60Hz | 1050mA

Potência do sistema: 40W

Material: alumínio/aço



Down 2400lm | 2700K | 2550lm | 3000K

Versão	Art. n.º	EUR
● Preto	1008002	485,00
○ Branco	1008003	485,00
● Latão	1008004	485,00

1007665 269





## ONE® CUBE PD, DALI

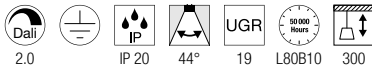
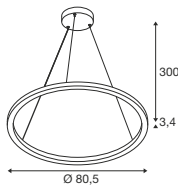

220-240V ~50/60Hz | 1400mA  
Potência do sistema: 54W  
Material: alumínio/aço



Down 4000lm | 3000K  
4300lm | 4000K

Versão	Art. n.º	EUR
● Preto 4000lm   3000K	<b>1007661</b>	<b>629,00</b>
● Preto 4300lm   4000K	<b>1007663</b>	<b>629,00</b>
○ Branco 4000lm   3000K	<b>1007662</b>	<b>629,00</b>
○ Branco 4300lm   4000K	<b>1007664</b>	<b>629,00</b>

## ONE® CUBE PD, DALI, up/down

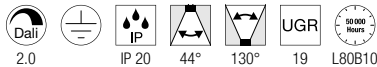
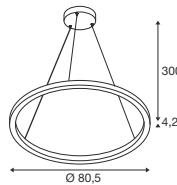

220-240V ~50/60Hz | 2100mA  
Potência do sistema: 80W  
Material: alumínio/aço



Up/Down 6000lm | 3000K  
6500lm | 4000K

Versão	Art. n.º	EUR
● Preto 6000lm   3000K	<b>1007665</b>	<b>699,00</b>
● Preto 6500lm   4000K	<b>1007671</b>	<b>699,00</b>
○ Branco 6000lm   3000K	<b>1007666</b>	<b>699,00</b>
○ Branco 6500lm   4000K	<b>1007672</b>	<b>699,00</b>

## ONE® Placa de feltro, feltro acústico, p/ ONE® 80/ ONE® CUBE



A: 3,8 cm  
Ø: 75,5 cm

- Adequado a todos os ONE®  
Anéis de luminária com Ø 80 cm

Versão	Art. n.º	EUR
● Cinzento	<b>1007746</b>	<b>109,00</b>





ONE® 60  
PD, DALI

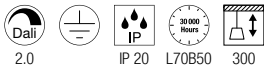
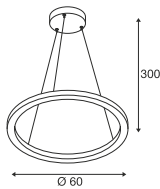

220-240V ~50/60Hz | 600mA  
Potência do sistema: 24W  
Material: alumínio/aço



Down 1480lm | 3000K | 1550lm | 4000K

Versão	Art. n.º	EUR
● Preto	1002909	423,00
○ Branco	1002910	423,00

ONE® 60  
PD, DALI, up/down

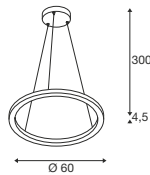

220-240V ~50/60Hz | 600mA  
Potência do sistema: 25W  
Material: alumínio/aço



Up 400lm | 3000K | 410lm | 4000K  
Down 400lm | 410lm

Versão	Art. n.º	EUR
● Preto	1004761	535,00
○ Branco	1004762	535,00

ONE® 60  
PD, PHASE, up/down

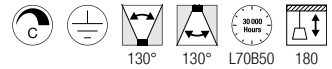
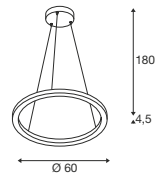

220-240V ~50/60Hz | 600mA  
Potência do sistema: 24W  
Material: alumínio/aço



Up 410lm | 2700K | 415lm | 3000K  
Down 410lm | 415lm

Versão	Art. n.º	EUR
● Preto	1004759	484,00
○ Branco	1004760	484,00
● Latão	1005177	504,00

1004763 273







ONE® 80  
PD, DALI

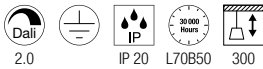
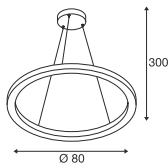

220-240V ~50/60Hz | 800mA  
Potência do sistema: 32W  
Material: alumínio/aço



Down 1930lm | 3000K | 2140lm | 4000K

Versão	Art. n.º	EUR
● Preto	1002911	474,00
○ Branco	1002912	474,00

ONE® 80  
PD, DALI, up/down

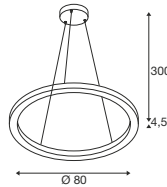

220-240V ~50/60Hz | 800mA  
Potência do sistema: 34W  
Material: alumínio/aço



Up 615lm | 3000K | 635lm | 4000K  
Down 615lm | 3000K | 635lm | 4000K

Versão	Art. n.º	EUR
● Preto	1004763	636,00
○ Branco	1004764	636,00

ONE®  
Placa de feltro, feltro acústico,  
p/ ONE® 80/ ONE® CUBE



A: 3,8 cm  
Ø: 75,5 cm

- Adequado a todos os ONE®  
Anéis de luminária com Ø 80 cm

Versão	Art. n.º	EUR
● Cinzento	1007746	109,00

ONE® DOUBLE  
PD, DALI, up/down

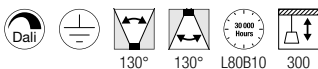
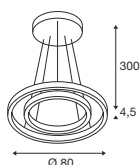

220-240V ~50/60Hz | 1400mA  
Potência do sistema: 55W  
Material: alumínio/aço



Up	1050lm	3000K	1060lm	4000K
Down	1050lm		1060lm	

Versão	Art. n.º	EUR
● Preto	1004767	1.110,00
○ Branco	1004768	1.110,00

ONE® DOUBLE  
PD, PHASE, up/down

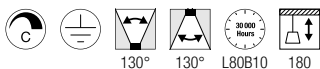
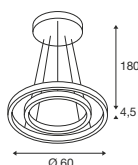

220-240V ~50/60Hz | 900mA  
Potência do sistema: 35W  
Material: alumínio/aço



Up	615lm	2700K	635lm	3000K
Down	615lm		635lm	

Versão	Art. n.º	EUR
● Preto	1004765	827,00
○ Branco	1004766	827,00
● Latão	1005178	848,00





ONE® TRIPLE  
PD, DALI

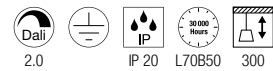
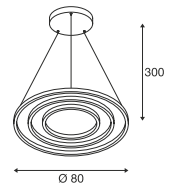

220-240V ~50/60Hz | 1700mA  
Potência do sistema: 64W  
Material: alumínio/aço



Down 4040lm | 3000K | 4200lm | 4000K

Versão	Art. n.º	EUR
● Preto	1002913	1.110,00
○ Branco	1002914	1.110,00

1005178 274





### ONE® LINEAR 100 PD, PHASE, up/down

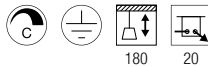
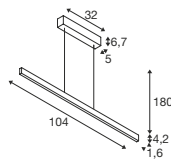

220-240V ~50/60Hz | 600mA  
Potência do sistema: 24W  
Material: alumínio/aço



Up	550lm	2700K	580lm	3000K
Down	700lm		670lm	

Versão	Art. n.º	EUR
● Preto	1006185	312,00
○ Branco	1006186	312,00
● Latão	1006187	333,00

### ONE® LINEAR 140 PD, PHASE, up/down

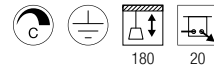
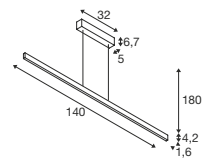

220-240V ~50/60Hz | 900mA  
Potência do sistema: 35W  
Material: alumínio/aço



Up	830lm	2700K	860lm	3000K
Down	980lm		1015lm	

Versão	Art. n.º	EUR
● Preto	1006188	368,00
○ Branco	1006189	368,00
● Latão	1006190	388,00



1007588 279



1007599 279



1007597 279



### PANTILO ROPE 19 PD, E27

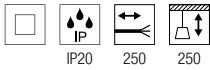
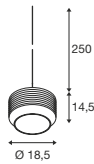

200-240V ~50/60Hz  
Material: vidro

- Extremidade do cabo aberta
- Encontra os acessórios correspondentes na página 299



Casquilho: 1xE27 Máx. Ø: 10 cm | C: 11 cm

Versão	Art. n.º	EUR
● Ambar/dourado	1007597	199,00
● Antracite/prateado	1007596	199,00



A60 | 7,5W | 180°  
2700K | 720lm | CEE=F  
8kWh/1000h



Art. N.º: 1005305 | 19,00 EUR

### PANTILO ROPE 20 PD, E27

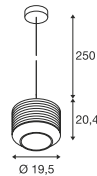
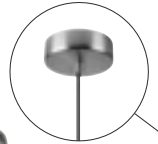

200-240V ~50/60Hz  
Material: vidro



Casquilho: 1xE27 Máx. Ø: 10 cm | C: 18 cm

Versão	Art. n.º	EUR
● Ambar/dourado	1007589	239,00
● Antracite/prateado	1007588	239,00



A60 | 7,5W | 180°  
2700K | 720lm | CEE=F  
8kWh/1000h



Art. N.º: 1005305 | 19,00 EUR

### PANTILO ROPE 27 PD, E27

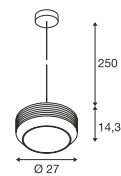
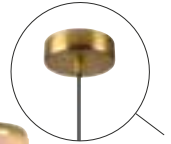

200-240V ~50/60Hz  
Material: vidro



Casquilho: 1xE27 Máx. Ø: 15 cm | C: 11 cm

Versão	Art. n.º	EUR
● Ambar/dourado	1007599	259,00
● Antracite/prateado	1007598	259,00



A60 | 7,5W | 180°  
2700K | 720lm | CEE=F  
8kWh/1000h



Art. N.º: 1005305 | 19,00 EUR



Artigo	Art. n.º	EUR
Adaptador para calha eletrificada monof.		
● Preto	143120	15,00
○ Branco	143121	15,00
● Cinzento	143124	15,00
Adaptador para calha eletrificada trif.		
● Preto	145990	19,70
● Cinzento	145994	19,70
○ Branco	1001542	19,70
Roseta saliente para teto		
● Preto	1004744	34,00
○ Branco	1004745	34,00
● Dourado	1006377	37,25
FITU roseta para teto, redonda, 1 saída		
● Preto	132600	26,00
○ Branco	132601	26,00
● Dourado	1002163	28,50
● Cromado	132605	28,50







### PANTILO OVAL PD, E27

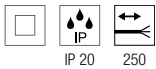
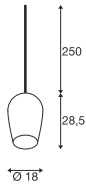

200-240V ~50/60Hz  
Material: vidro

- Extremidade do cabo aberta
- Encontra os acessórios correspondentes na página 299



Casquilho: 1xE27

Versão	Art. n.º	EUR
○ Branco	1006402	155,00
● Dourado	1006403	175,00
● Cromado	1006398	175,00
● Cobre	1006400	175,00



A60 | 7,5W | 180°  
2700K | 720lm | CEE=F  
8kWh/1000h



Art. N.º: 1005305 | 19,00 EUR



Artigo	Art. n.º	EUR
Adaptador para calha eletrificada monof.		
● Preto	143120	15,00
○ Branco	143121	15,00
● Cinzento	143124	15,00
Adaptador para calha eletrificada trif.		
● Preto	145990	19,70
● Cinzento	145994	19,70
○ Branco	1001542	19,70
Roseta saliente para teto		
● Preto	1004744	34,00
○ Branco	1004745	34,00
● Dourado	1006377	37,25
FITU, roseta para teto redonda, 1 saída		
● Preto	132600	26,00
○ Branco	132601	26,00
● Dourado	1002163	28,50
● Cromado	132605	28,50

### PANTILO 20 PD, E27

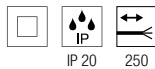
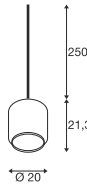

200-240V ~50/60Hz  
Material: vidro

- Extremidade do cabo aberta
- Encontra os acessórios correspondentes na página 299



Casquilho: 1xE27

Versão	Art. n.º	EUR
○ Branco	1006396	155,00
● Dourado	1006395	175,00
● Cromado	1003004	175,00
● Cobre	1003005	175,00



A60 | 7,5W | 180°  
2700K | 720lm | CEE=F  
8kWh/1000h



Art. N.º: 1005305 | 19,00 EUR



Artigo	Art. n.º	EUR
Adaptador para calha eletrificada monof.		
● Preto	143120	15,00
○ Branco	143121	15,00
● Cinzento	143124	15,00
Adaptador para calha eletrificada trif.		
● Preto	145990	19,70
● Cinzento	145994	19,70
○ Branco	1001542	19,70
Roseta saliente para teto		
● Preto	1004744	34,00
○ Branco	1004745	34,00
● Dourado	1006377	37,25
FITU, roseta para teto redonda, 1 saída		
● Preto	132600	26,00
○ Branco	132601	26,00
● Dourado	1002163	28,50
● Cromado	132605	28,50

### PANTILO 28 PD, E27

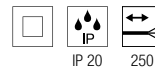
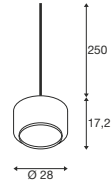

200-240V ~50/60Hz  
Material: vidro

- Extremidade do cabo aberta
- Encontra os acessórios correspondentes na página 299



Casquilho: 1xE27

Versão	Art. n.º	EUR
○ Branco	1006399	191,00
● Dourado	1006397	211,00
● Cromado	1003006	211,00
● Cobre	1003007	211,00



A60 | 7,5W | 180°  
2700K | 720lm | CEE=F  
8kWh/1000h



Art. N.º: 1005305 | 19,00 EUR



Artigo	Art. n.º	EUR
Adaptador para calha eletrificada monof.		
● Preto	143120	15,00
○ Branco	143121	15,00
● Cinzento	143124	15,00
Adaptador para calha eletrificada trif.		
● Preto	145990	19,70
● Cinzento	145994	19,70
○ Branco	1001542	19,70
Roseta saliente para teto		
● Preto	1004744	34,00
○ Branco	1004745	34,00
● Dourado	1006377	37,25
FITU, roseta para teto redonda, 1 saída		
● Preto	132600	26,00
○ Branco	132601	26,00
● Dourado	1002163	28,50
● Cromado	132605	28,50





### PANTILO CONVEX 29 PD, E27

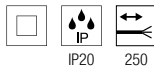
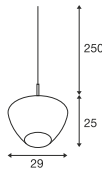

220-240V ~50/60Hz  
Material: vidro

- Extremidade do cabo aberta
- Encontra os acessórios correspondentes na página 299



Casquilho: E27 Máx. Ø: 10 cm C: 20 cm

Versão	Art. n.º	EUR
○ Branco	1007881	227,00
● Dourado	1007880	247,00
● Cromado	1003443	247,00
● Cobre	1007879	247,00



Tubo LED 30 | 6W | 330°  
2200K | 570lm | CEE=F  
6kWh/1000h



Art. N.º: 1008152 | 64,00 EUR



Artigo	Art. n.º	EUR
--------	----------	-----

Adaptador para calha eletrificada monof.

● Preto	143120	15,00
○ Branco	143121	15,00
● Cinzento	143124	15,00

Adaptador para calha eletrificada trif.

● Preto	145990	19,70
● Cinzento	145994	19,70
○ Branco	1001542	19,70

Roseta saliente para teto

● Preto	1004744	34,00
○ Branco	1004745	34,00
● Dourado	1006377	37,25

FITU, roseta para teto redonda, 1 saída

● Preto	132600	26,00
○ Branco	132601	26,00
● Dourado	1002163	28,50
● Cromado	132605	28,50

### PANTILO CONVEX 40 PD, E27

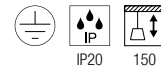
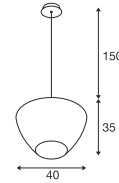

220-240V ~50/60Hz  
Material: vidro



Casquilho: E27 Máx. Ø: 15 cm C: 30 cm

Versão	Art. n.º	EUR
○ Branco	1007878	343,00
● Dourado	1007877	363,00
● Cromado	1003444	353,00
● Cobre	1007876	363,00



E27 | 6W | 330°  
2200K | 570lm | CEE=F  
6kWh/1000h



Art. N.º: 1008153 | 54,00 EUR

1008179 285





LIGHT EYE® 90  
PD, QPAR51



NEW

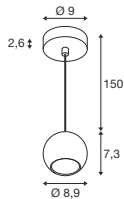

220-240V ~50/60Hz  
Material: aço



Casquilho: 1xGU10 Máx. Ø: 5,1 cm | C: 5,35 cm

Versão	Art. n.º	EUR
● Preto	1008172	84,00
○ Branco	1008173	84,00



LED GU10 51 mm | 6W | 38°  
2700K | 450lm | CEE=F  
6kWh/1000h



Art. N.º: 1005077 | 7,50 EUR

LIGHT EYE® 150  
PD, QPAR111



NEW

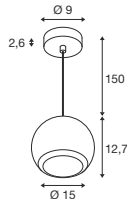

220-240V ~50/60Hz  
Material: aço



Casquilho: 1xGU10 máx. Ø: 11,1 cm | C: 7 cm

Versão	Art. n.º	EUR
● Preto	1008178	132,00
○ Branco	1008179	132,00



QPAR111 | 12W | 55°  
2700K | 670lm | CEE=G  
12kWh/1000h



Art. N.º: 1005297 | 85,00 EUR

LIGHT EYE® 90  
Deco Ring Ø 5,7 cm



NEW

Material: aço/aço

Versão	Art. n.º	EUR
● Preto	1008186	9,00
○ Branco	1008187	9,00
● Dourado	1008188	14,00

LIGHT EYE® 150  
Deco Ring Ø 13,6 cm



NEW

Material: aço/aço

Versão	Art. n.º	EUR
● Preto	1008189	35,00
○ Branco	1008190	35,00
● Dourado	1008192	45,00
● Cromado	1008191	45,00

1006438 287





## ASTO TUBE

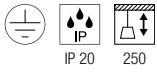

220-240V ~50/60Hz  
Material: alumínio

- Inclui refletor decorativo na cor do produto, feito de plástico reciclado
- Outros refletores decorativos coloridos disponíveis como opção



Casquilho: 1xGU10



LED GU10 51 mm | 6W | 36°  
2200-2700K | 360lm | CEE=G  
6kWh/1000h



Art. N.º: 1005273 | 9,99 EUR

## ASTO TUBE PD, single, GU 10

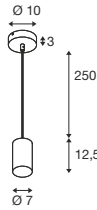

Versão	Art. n.º	EUR
● Preto	1006431	60,00
○ Branco	1006432	60,00

## ASTO TUBE PD, double, GU 10

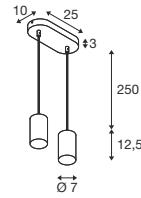
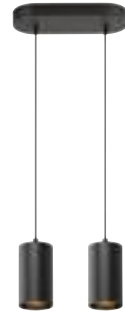

Versão	Art. n.º	EUR
● Preto	1006433	110,00
○ Branco	1006434	110,00

## ASTO TUBE Refletor decorativo



A: 3,95 cm  
Ø: 6,75 cm  
Material: policarbonato (PC)

## ASTO TUBE PD, triple, GU 10

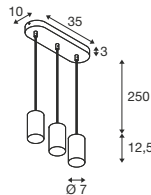

Versão	Art. n.º	EUR
● Preto	1006435	160,00
○ Branco	1006436	160,00

## ASTO TUBE PD, quadruple, GU 10

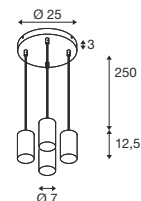
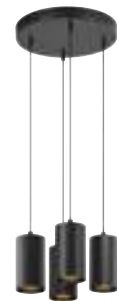

Versão	Art. n.º	EUR
● Preto	1006437	195,00
○ Branco	1006438	195,00

Versão	Art. n.º	EUR
● Preto/cromado	1007190	4,00
● Dourado	1006450	4,00
● Cromado	1006449	4,00
● Cobre	1006451	4,00







### WORKLIGHT PRO 120 PD, DALI

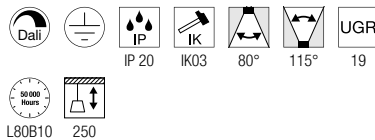
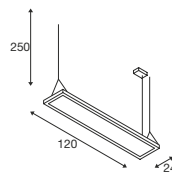

200-240V ~50/60Hz | 1200mA  
Potência do sistema: 50W  
Material: alumínio/aço



Up 2800lm | 4000K  
Down 3300lm

Versão	Art. n.º	EUR
● Preto	1007468	499,00
○ Branco	1007469	499,00
● Cinzento	1007470	499,00

### WORKLIGHT PRO 150 PD, DALI

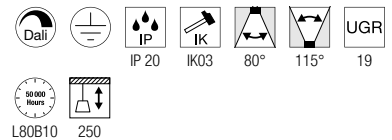
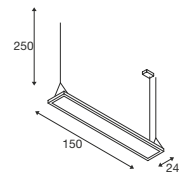

220-240V ~50/60Hz | 1400mA  
Potência do sistema: 59W  
Material: alumínio/aço



Up 3300lm | 4000K  
Down 3900lm

Versão	Art. n.º	EUR
● Preto	1007471	599,00
○ Branco	1007472	599,00
● Cinzento	1007473	599,00

# WORKLIGHT PD, DALI

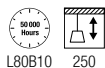
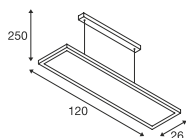
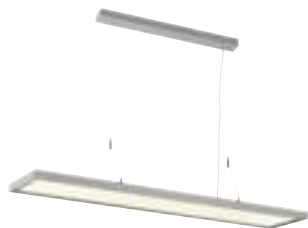

200-240V ~50/60Hz | 1550mA  
Potência do sistema: 57W  
Material: alumínio



Up 2000lm | 4000K  
Down 3000lm

Versão	Art. n.º	EUR
● Preto	1005395	469,00
○ Branco	1005396	469,00
○ Prateado	1006345	469,00

1006345 288





PANEL 60  
PD, Redondo, DALI

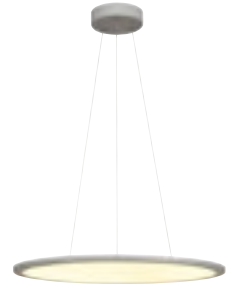

1001344 289

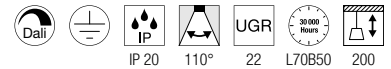
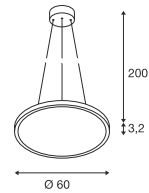

120-277V ~50/60Hz | 1000mA  
Potência do sistema: 43W  
Material: alumínio/polimetilacrilato (PMMA)



Down 3150lm | 3000K  
3350lm | 4000K

Versão	Art. n.º	EUR
○ Branco 3150lm   3000K	<b>1003044</b>	<b>324,00</b>
○ Branco 3350lm   4000K	<b>1003045</b>	<b>324,00</b>
● Cinzento 3150lm   3000K	<b>1003046</b>	<b>324,00</b>
● Cinzento 3350lm   4000K	<b>1003047</b>	<b>324,00</b>

NOYA  
PD, PHASE

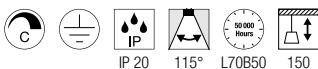
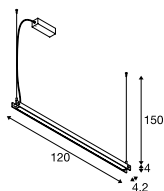
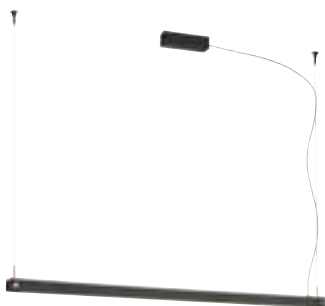

220-240V ~50/60Hz | 700mA  
Potência do sistema: 32W  
Material: alumínio/policarbonato (PC)



Down 1861lm | 2700K | 2025lm | 3000K

Versão	Art. n.º	EUR
● Preto	1003530	479,00
○ Branco	1003532	479,00



1003530 290



1001403 291



1001409 291

**GLENOS**  
PD, 1m, 1-10V

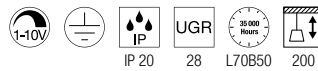
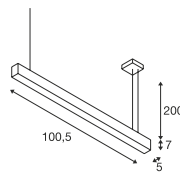

220-240V ~50/60Hz | 1000mA  
Potência do sistema: 43W  
Material: alumínio/plástico



Down 2850lm | 3000K  
3300lm | 4000K

Versão	Art. n.º	EUR
● Preto 2850lm   3000K	<b>1001400</b>	<b>393,00</b>
● Preto 3300lm   4000K	<b>1001403</b>	<b>393,00</b>

**GLENOS**  
PD, 2m, 1-10V

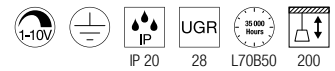
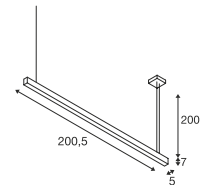

220-240V ~50/60Hz | 1000mA  
Potência do sistema: 85W  
Material: alumínio/plástico



Down 5700lm | 3000K  
6600lm | 4000K

Versão	Art. n.º	EUR
● Preto 5700lm   3000K	<b>1001406</b>	<b>540,00</b>
● Preto 6600lm   4000K	<b>1001409</b>	<b>540,00</b>



1001309 295



1000933 295



**Q-LINE®**  
PD, 1m, BAP, PHASE

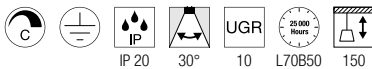
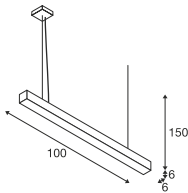

220-240V ~50/60Hz | 900mA  
Potência do sistema: 46W  
Material: alumínio/plástico



Down 2100lm | 3000K  
2300lm | 4000K

Versão	Art. n.º	EUR
● Preto		
2100lm   3000K	<b>1000927</b>	<b>484,00</b>
● Preto		
2300lm   4000K	<b>1000933</b>	<b>484,00</b>
○ Branco		
2100lm   3000K	<b>1000926</b>	<b>484,00</b>
○ Branco		
2300lm   4000K	<b>1000932</b>	<b>484,00</b>

**Q-LINE®**  
PD, 2m, BAP, PHASE

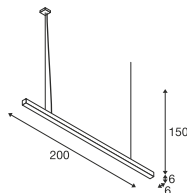

220-240V ~50/60Hz | 900mA  
Potência do sistema: 93W  
Material: alumínio/plástico



Down 4200lm | 3000K  
4600lm | 4000K

Versão	Art. n.º	EUR
● Preto		
4200lm   3000K	<b>1000930</b>	<b>726,00</b>
● Preto		
4600lm   4000K	<b>1000936</b>	<b>726,00</b>
○ Branco		
4200lm   3000K	<b>1000929</b>	<b>726,00</b>
○ Branco		
4600lm   4000K	<b>1000935</b>	<b>726,00</b>

**Q-LINE®**  
PD, DALI, single

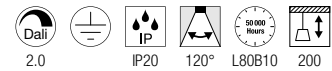
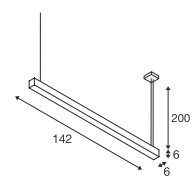

220-240V ~50/60Hz | 1150mA  
Potência do sistema: 46W  
Material: alumínio/plástico PC



Down 4100lm | 3000K

Versão	Art. n.º	EUR
● Preto	<b>1001309</b>	<b>580,00</b>
○ Branco	<b>1001310</b>	<b>580,00</b>

# OCULUS

PD, single, PHASE

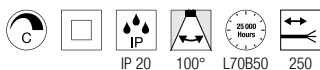

220-240V ~50/60Hz | 250mA

Potência do sistema: 11W

Material: alumínio/vidro

- Incluída lente fosca adicional
- Encontra os acessórios correspondentes na página 299
- Extremidade do cabo aberta



Down 36lm | 2000K - 780lm | 3000K

Versão	Art. n.º	EUR
● Preto	<b>1004672</b>	<b>209,00</b>
○ Branco	<b>1004673</b>	<b>209,00</b>



Artigo	Art. n.º	EUR
Adaptador para calha eletrificada monof.		
● Preto	<b>143120</b>	<b>15,00</b>
○ Branco	<b>143121</b>	<b>15,00</b>
● Cinzento	<b>143124</b>	<b>15,00</b>
Adaptador para calha eletrificada trif.		
● Preto	<b>145990</b>	<b>19,70</b>
● Cinzento	<b>145994</b>	<b>19,70</b>
○ Branco	<b>1001542</b>	<b>19,70</b>
Roseta saliente para teto		
● Preto	<b>1004744</b>	<b>34,00</b>
○ Branco	<b>1004745</b>	<b>34,00</b>
● Dourado	<b>1006377</b>	<b>37,25</b>
FITU, roseta para teto redonda, 1 saída		
● Preto	<b>132600</b>	<b>26,00</b>
○ Branco	<b>132601</b>	<b>26,00</b>
● Dourado	<b>1002163</b>	<b>28,50</b>
● Cromado	<b>132605</b>	<b>28,50</b>







# OCULUS PD, DTW

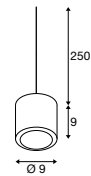

1008617 297



220-240V ~50/60Hz | 250mA  
Potência do sistema: 11W  
Material: alumínio



Down 36lm | 2000K - 780lm | 3000K

Versão	Art. n.º	EUR
● Latão (PVD)	<b>1008616</b>	<b>295,00</b>
● Cobre escuro (PVD)	<b>1008617</b>	<b>295,00</b>
● Bronze escuro (PVD)	<b>1008615</b>	<b>295,00</b>





# FITU PD, E27

MIX match

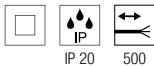
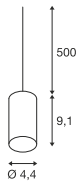

220-240V ~50/60Hz  
Material: alumínio

- Cabo em tecido
- Extremidade do cabo aberta



Casquilho: 1xE27

Versão	Art. n.º	EUR
● Preto	132690	60,00
○ Branco	132691	60,00



A60 | 7,5W | 320°  
2700K | 800lm | CEE=F  
8kWh/1000h



Art. N.º: 1005303 | 9,60 EUR

## FITU 1.ª roseta para teto

16A máx.  
Aço  
A: 3,9 cm  
Ø: 8,5 cm  
Incl. alívio de tensão



Versão	Art. n.º	EUR
● Preto	132600	26,00
○ Branco	132601	26,00
● Dourado	1002163	28,50
● Cromado	132605	28,50

## Roseta para encastrar no teto

16A máx.  
Aço/Poliamida 66 (PA 66)  
A: 3,3 cm  
Ø: 8,5 cm



Versão	Art. n.º	EUR
● Preto	1004674	22,50
○ Branco	1004675	22,50
● Dourado	1006378	27,00

## Adaptador para calha eletrificada monof.

6 A máx.  
Policarbonato (PC)  
C: 8,5 cm L: 3,5 cm A: 3,2 cm  
Carga mec. máx. 2 kg



Versão	Art. n.º	EUR
● Preto	143120	15,00
○ Branco	143121	15,00
● Cinzento	143124	15,00

## Gancho de cabo

Alumínio  
C: 3,1 cm  
Ø: 1,4 cm



Versão	Art. n.º	EUR
● Preto	132680	12,50
○ Branco	132681	12,50

## FITU 3.ª roseta para teto

16A máx.  
Aço  
A: 5,4 cm  
Ø: 22 cm  
Incl. alívio de tensão



Versão	Art. n.º	EUR
● Preto	132610	63,00
○ Branco	132611	63,00

## Roseta saliente para teto

16A máx.  
Aço  
A: 2,6 cm  
Ø: 9 cm



Versão	Art. n.º	EUR
● Preto	1004744	34,00
○ Branco	1004745	34,00
● Dourado	1006377	37,25

## Gancho para teto

Alumínio  
C: 4,6 cm  
Ø: 1,8 cm



Versão	Art. n.º	EUR
● Preto	132670	19,20
○ Branco	132671	19,20

## Adaptador para calha eletrificada trif.

10 A máx.  
Plástico  
C: 9,6 cm L: 3,5 cm A: 4,5 cm  
Carga Carga 5 kg



Versão	Art. n.º	EUR
● Preto	145990	19,70
○ Branco	1001542	19,70
● Cinzento	145994	19,70

## FENDA PD, E27

MIX  
match

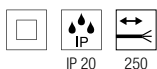
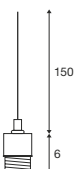

220-240V ~50/60Hz  
Material: aço/plástico

- Encontra os acessórios correspondentes nas páginas 300-301
- Extremidade do cabo aberta

SOCKET  
INSIDE <60  
W

Casquilho: 1xE27

Versão	Art. n.º	EUR
● Preto	132660	29,25
○ Branco	132661	29,25
● Cromado	132662	33,00



A60 | 7,5W | 320°  
2700K | 800lm | CEE=F  
8kWh/1000h



Art. N.º: 1005303 | 9,60 EUR



Artigo	Art. n.º	EUR
Adaptador para calha eletrificada monof.		
● Preto	143120	15,00
○ Branco	143121	15,00
● Cinzento	143124	15,00
Adaptador para calha eletrificada trif.		
● Preto	145990	19,70
● Cinzento	145994	19,70
○ Branco	1001542	19,70
Roseta saliente para teto		
● Preto	1004744	34,00
○ Branco	1004745	34,00
● Dourado	1006377	37,25
FITU, roseta para teto redonda, 1 saída		
● Preto	132600	26,00
○ Branco	132601	26,00
● Dourado	1002163	28,50
● Cromado	132605	28,50

## FENDA Difusor em vidro 12,5 cm, Redondo

MIX  
match



A: 20 cm  
Ø: 12,5 cm  
Material: vidro

Versão	Art. n.º	EUR
● Castanho	1000773	65,00

## FENDA 15 cm, Redondo

MIX  
match



A: 40 cm  
Ø: 15 cm  
Material: têxtil/aço

Versão	Art. n.º	EUR
● Cinzento	1004773	44,75





**FENDA**  
30 cm, Redondo

MIX  
match



A: 20 cm  
Ø: 30 cm  
Material: têxtil/aço

Versão	Art. n.º	EUR
● Preto/cobre	155592	70,00
○ Branco	155582	53,00
● Cinzento	1004774	53,00
● Bege	155583	53,00

**FENDA**  
Ø 45 cm, Redondo

MIX  
match



A: 28 cm  
Ø: 45,5 cm  
Material: têxtil/aço

Versão	Art. n.º	EUR
● Preto/cobre	156122	88,00
○ Branco	156111	83,00
● Cinzento	1004775	83,00
● Bege	156113	83,00



Artigo	Art. n.º	EUR
Difusor em vidro acrílico para FENDA Ø 45,5 cm		
○ Branco	156100	44,50

**FENDA**  
Ø 70 cm, Redondo

MIX  
match



A: 36 cm  
Ø: 70 cm  
Material: têxtil/aço



IP 20

Versão	Art. n.º	EUR
● Preto/cobre	1000580	129,00
○ Branco	1000579	112,00



Artigo	Art. n.º	EUR
Difusor em vidro acrílico para FENDA Ø 70 cm		
○ Branco	1000957	94,00

132661 + 1000579

300 + 301

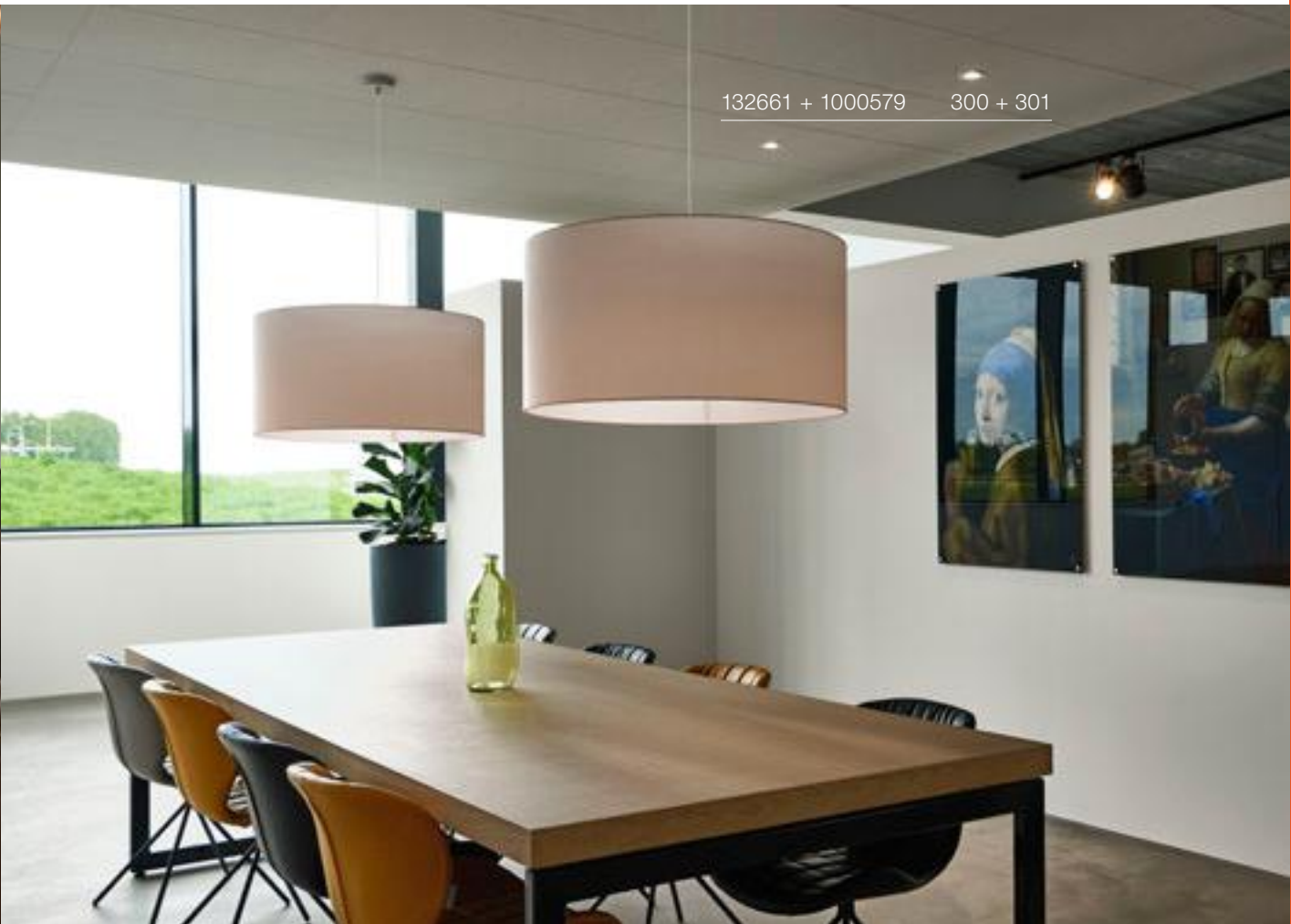

# MIX & MATCH FENDA

---

## FENDA TL

Preto | 155780

## FENDA FL

Preto | 155790

## FENDA TL

Preto | 155540

## FENDA FL

Preto | 155490

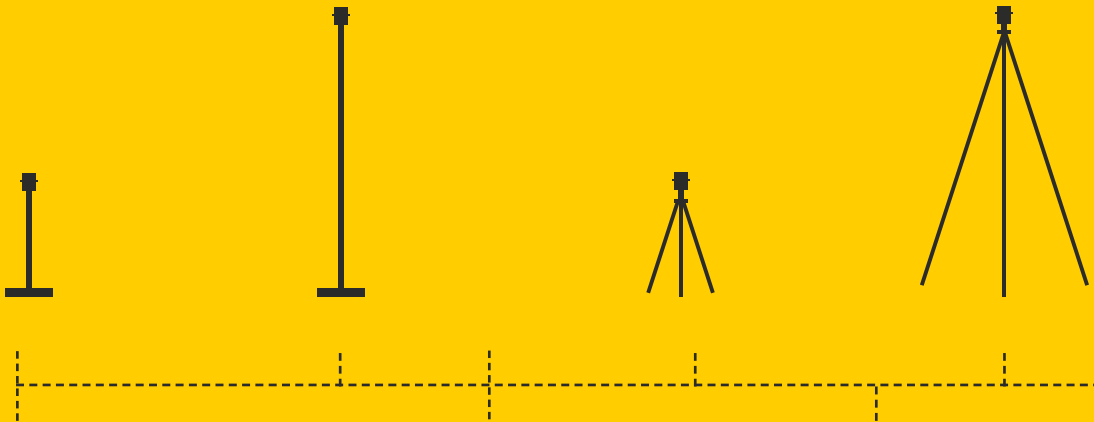

## FENDA Ø15

Preto | 156152  
Branco | 156141  
Bege | 156143  
Cinzeno | 1004773

## FENDA Ø30

Preto | 155592  
Branco | 155582  
Bege | 155583  
Cinzeno | 1004774

## FENDA Ø45

Preto | 156122  
Branco | 156111  
Bege | 156113  
Cinzeno | 1004775

### FITU PD

Preto | 132690  
Branco | 132691



### FENDA PD

Preto | 132660  
Branco | 132661  
Cromado | 132662

### FENDA CL

Preto | 155550  
Branco | 155551

### FITU CRANE BASE

Preto | 1004682

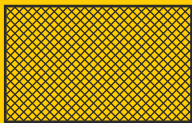

### FENDA Ø70

Preto | 1000580  
Branco | 1000579



### FENDA Ø12,5

*Glass Shade*

Castanho | 1000773



A FITU CRANE BASE  
também pode ser  
combinada com os  
abajures FENDA PD e  
os abajures FENDA

Combine os produtos SLV Mix & Match totalmente de acordo com o seu gosto. Perfeitamente compatíveis entre si, encontra artigos a combinar não só da gama FENDA mas também entre as famílias de produtos FENDA e FITU. Identifica os produtos SLV Mix & Match pelo símbolo seguinte:



**MIX**  
match

## HELIA AMBIENT 35 PD, PHASE

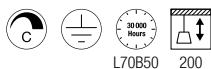
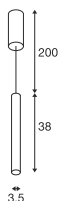
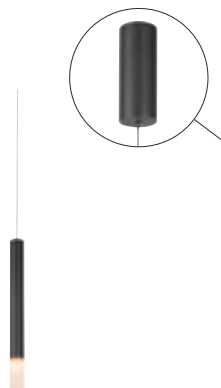

L70B50 200

220-240V ~50/60Hz | 500mA  
Potência do sistema: 9W  
Material: alumínio/acrílico



Down 425lm | 3000K

Versão	Art. n.º	EUR
● Preto	1003436	219,00

## HELIA AMBIENT 35 PD

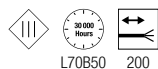
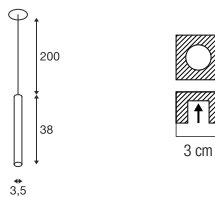

L70B50 200

500mA  
Potência do sistema: 7,5W  
Material: alumínio/acrílico

- Extremidade do cabo aberta
- Roseta para encastrar incl.
- Ø da roseta para encastrar 68 mm
- Espessura do material da área de instalação: máx. 12 mm



Down 425lm | 3000K

Versão	Art. n.º	EUR
● Preto	1003435	179,00



Artigo	Art. n.º	EUR
Controlador LED 20W   350mA/500mA   PHASE		
○ Branco	1007227	40,00
Controlador LED 25W   150-700mA   DALI regulável		
○ Branco	1007229	70,00

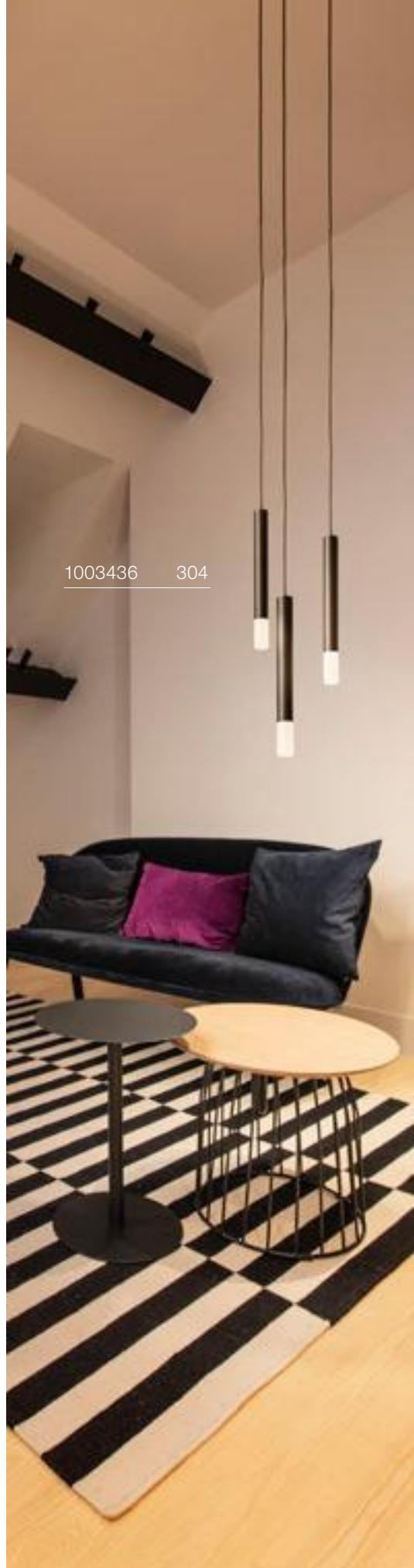

1003436 304





## HELIA 30 PD, PHASE

## HELIA 30 PD

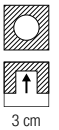
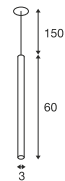
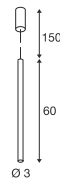
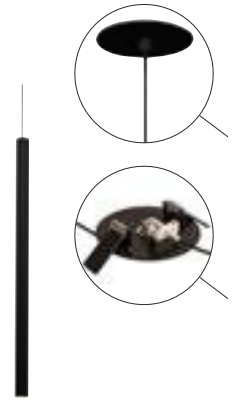
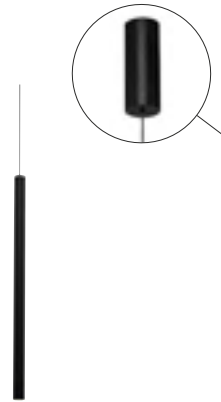

152360 305

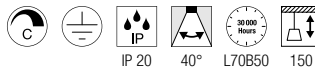

220-240V ~50/60Hz | 500mA  
Potência do sistema: 9,2W  
Material: alumínio



500mA  
Potência do sistema: 7,5W  
Material: alumínio

- Extremidade do cabo aberta
- Roseta para encastrar incl.
- Ø da roseta para encastrar 68 mm
- Espessura do material da área de instalação: máx. 12 mm



Down 590lm | 3000K

Versão	Art. n.º	EUR
● Preto	152360	219,00



Down 500lm | 3000K

Versão	Art. n.º	EUR
● Preto	158400	179,00



Artigo	Art. n.º	EUR
Controlador LED 20W   350mA/500mA   PHASE		
○ Branco	1007227	40,00
Controlador LED 25W   150-700mA   DALI regulável		
○ Branco	1007229	70,00

153270 307





158400

307

### HELIA 40 PD, PHASE

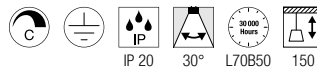
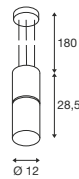
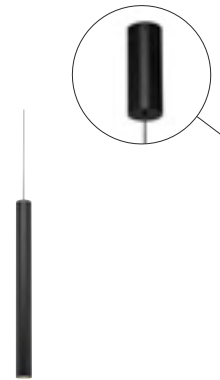

220-240V ~50/60Hz | 500mA  
Potência do sistema: 10W  
Material: alumínio



Down 730lm | 3000K

Versão	Art. n.º	EUR
● Preto	152370	249,00

### HELIA 40 PD

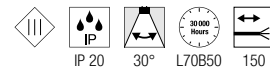
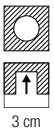
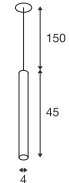
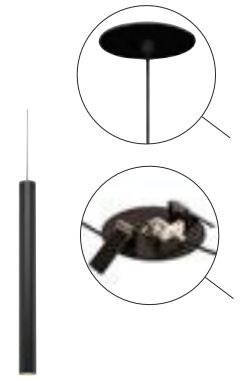

500mA  
Potência do sistema: 9W  
Material: alumínio

- Roseta para encastrar incl.
- Ø da roseta para encastrar 68 mm
- Espessura do material da área de instalação: máx. 12 mm



Down 700lm | 3000K

Versão	Art. n.º	EUR
● Preto	158410	199,00



Artigo	Art. n.º	EUR
Controlador LED 20W   350mA/500mA   PHASE		
○ Branco	1007227	40,00
Controlador LED 25W   150-700mA   DALI regulável		
○ Branco	1007229	70,00



149388

309



### ASTINA PD, QPAR51

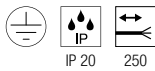
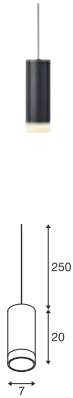

220-240V ~50/60Hz  
Material: alumínio

- Encontra os acessórios correspondentes na página 299
- Extremidade do cabo aberta



Casquilho: 1xGU10

Versão	Art. n.º	EUR
● Preto	1002939	117,00
○ Branco	1002937	117,00



LED GU10 51 mm | 6W | 36°  
2200-2700K | 360lm | CEE=G  
6kWh/1000h



Art. N.º: 1005273 | 9,99 EUR

### ENOLA B PD, QPAR51

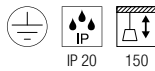

220-240V ~50/60Hz  
Material: alumínio/aço



Casquilho: 1xGU10

Versão	Art. n.º	EUR
● Preto	151850	110,00
○ Branco	151851	110,00
● Dourado	151853	115,00



LED GU10 51 mm | 6W | 38°  
2700K | 450lm | CEE=F  
6kWh/1000h



Art. N.º: 1005077 | 7,50 EUR

### ENOLA PD, E27

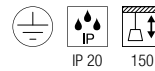
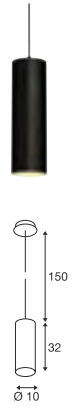

220-240V ~50/60Hz  
Material: alumínio/aço



Casquilho: 1xE27

Máx. Ø: 9 cm | C: 18 cm

Versão	Art. n.º	EUR
● Preto	1008135	81,00
○ Branco	1008133	81,00
● Dourado	1008134	94,00



LED E27 | 13,2W | 220°  
2700K | 1300lm | CEE=F  
13kWh/1000h



Art. N.º: 1005302 | 12,25 EUR



Artigo	Art. n.º	EUR
Adaptador para calha eletrificada monof.		
● Preto	143120	15,00
○ Branco	143121	15,00
● Cinzento	143124	15,00
Adaptador para calha eletrificada trif.		
● Preto	145990	19,70
● Cinzento	145994	19,70
○ Branco	1001542	19,70
FITU, roseta para teto, redonda, 1 saída		
● Preto	132600	26,00
○ Branco	132601	26,00
● Cromado	132605	28,50
FITU, roseta para teto, redonda, 3 saídas		
● Preto	132610	63,00
○ Branco	132611	63,00

ANELA  
PD, PHASE

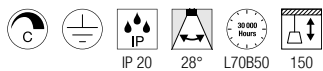
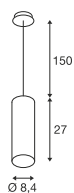

220-240V ~50/60Hz | 500mA  
Potência do sistema: 10W  
Material: alumínio

- Sem refletor
- Fluxo luminoso com refletor  
1000809 = 500lm



Down 220lm | 3000K | 750lm |

Versão	Art. n.º	EUR
● Preto	1000813	189,00



Artigo	Art. n.º	EUR
Refletor 28°		
● Dourado	1000809	19,75

1000813 310





133444 311

**TONGA®**  
PD, E14

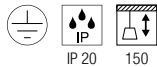
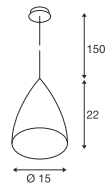

220-240V ~50/60Hz  
Material: alumínio/vidro

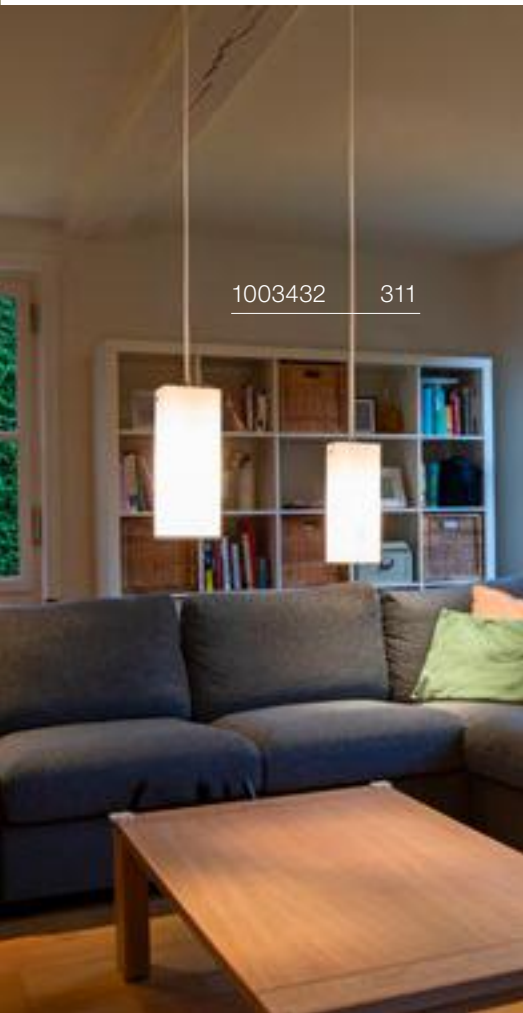

1003432 311

**QUADRASS**  
PD, E27

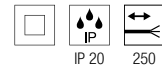
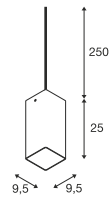

220-240V ~50/60Hz  
Material: aço/vidro

- Encontra os acessórios correspondentes na página 299
- Extremidade do cabo aberta



Casquilho: 1xE14 Máx. Ø: 5,1 cm | C: 13 cm

Versão	Art. n.º	EUR
● Cinzento	133444	129,00



C35 | 4,2W | 320°  
2700K | 350lm | CEE=G  
5kWh/1000h



Art. N.º: 1005285 | 8,50 EUR



Casquilho: 1xE27 Máx. Ø: 6,5 cm | C: 18 cm

Versão	Art. n.º	EUR
● Cromado	1003432	104,00



LED E27 | 13,2W | 220°  
2700K | 1300lm | CEE=F  
13kWh/1000h



Art. N.º: 1005302 | 12,25 EUR



Artigo	Art. n.º	EUR
Adaptador para calha eletrificada monof.		
○ Branco	143121	15,00
Adaptador para calha eletrificada trif.		
○ Branco	1001542	19,70
FITU 1.ª roseta para teto		
○ Branco	132601	26,00



133050 313





133019

313

PARA CONE 20  
PD, E27

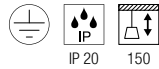
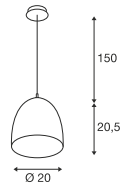

220-240V ~50/60Hz  
Material: alumínio/aço

- Cabo em tecido



Casquilho: 1xE27

Versão	Art. n.º	EUR
● Preto/dourado	1008129	117,00
● Cobre/branco	1008130	164,00



E27 | 6W | 330°  
2200K | 570lm | CEE=F  
6kWh/1000h



Art. N.º: 1008153 | 54,00 EUR

PARA CONE 30  
PD, E27

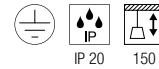
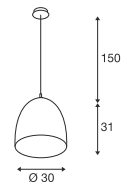

220-240V ~50/60Hz  
Material: alumínio/aço

- Cabo em tecido



Casquilho: 1xE27

Versão	Art. n.º	EUR
● Preto/dourado	1008131	198,00
● Cobre/branco	1008132	222,00



LED Rusika Soft | 6W | 330°  
2200K | 570lm | CEE=F  
6kWh/1000h



Art. N.º: 1008156 | 54,00 EUR

1002949 315

1002951 315

1002950 315





### PHELIA 10 PD, E27

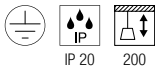
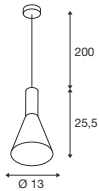

220-240V ~50/60Hz  
Material: alumínio

- Cabo em tecido



Casquilho: 1xE27

Versão	Art. n.º	EUR
● Preto/dourado	1002951	131,00



A60 | 7,5W | 180°  
2700K | 720lm | CEE=F  
8kWh/1000h



Art. N.º: 1005305 | 19,00 EUR

### PHELIA 20 PD, E27

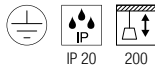
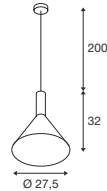

220-240V ~50/60Hz  
Material: alumínio

- Cabo em tecido



Casquilho: 1xE27

Versão	Art. n.º	EUR
● Preto/dourado	1002949	161,00



LED E27 | 13,2W | 220°  
2700K | 1300lm | CEE=F  
13kWh/1000h



Art. N.º: 1005302 | 12,25 EUR

### PHELIA 30 PD, E27

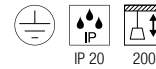
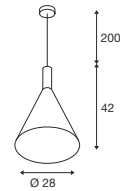

220-240V ~50/60Hz  
Material: alumínio

- Cabo em tecido



Casquilho: 1xE27

Versão	Art. n.º	EUR
● Preto/dourado	1002950	187,00



LED E27 | 7,5W | 320°  
2500K | 700lm | CEE=F  
8kWh/1000h



Art. N.º: 1005265 | 26,50 EUR

FORCHINI 50  
PD, E27

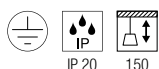
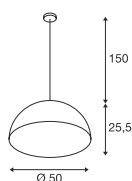

220-240V ~50/60Hz  
Material: GFK

- Cabo em tecido



Casquilho: 1xE27 Máx. C: 20 cm

Versão	Art. n.º	EUR
● Preto/dourado	1008535	228,00



Art. N.º: 1008156 | 54,00 EUR

FORCHINI 70  
PD, E27

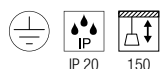
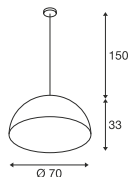

220-240V ~50/60Hz  
Material: GFK

- Cabo em tecido



Casquilho: 1xE27 Máx. C: 20 cm

Versão	Art. n.º	EUR
● Preto/dourado	1008538	403,00



Art. N.º: 1008152 | 64,00 EUR

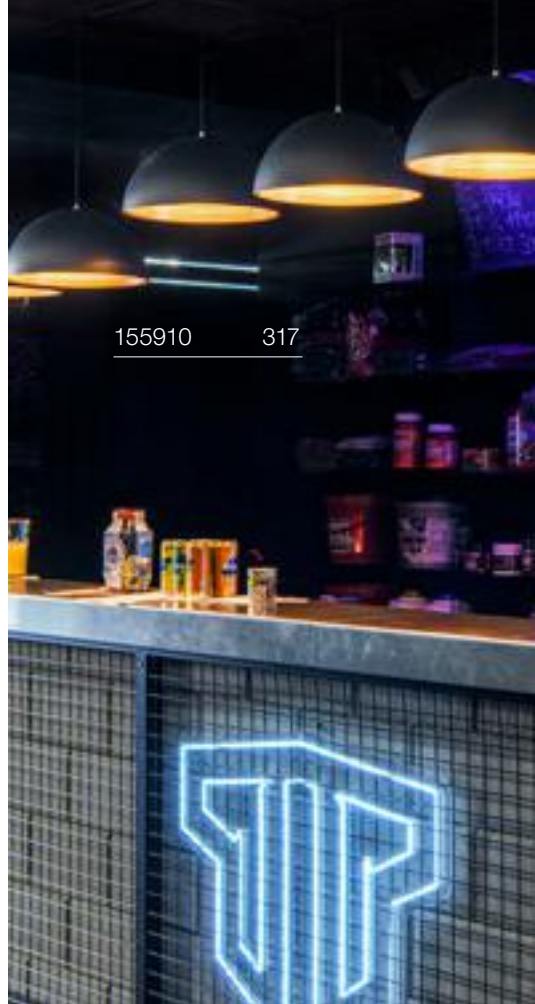

155910 317



1001701 316



FORCHINI M 40  
PD, E27

FORCHINI M 50  
PD, E27

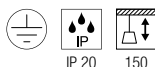
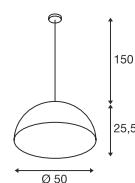
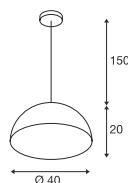
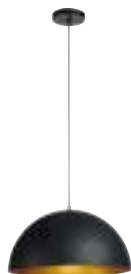

220-240V ~50/60Hz  
Material: alumínio/aço

- Cabo em tecido



Casquilho: 1xE27

Máx. C: 15,2 cm

Versão	Art. n.º	EUR
● Preto/dourado	1008536	228,00



A60 | 7,5W | 180°  
2700K | 720lm | CEE=F  
8kWh/1000h



Art. N.º: 1005305 | 19,00 EUR

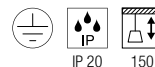

220-240V ~50/60Hz  
Material: alumínio/aço

- Cabo em tecido



Casquilho: 1xE27

Máx. C: 18 cm

Versão	Art. n.º	EUR
● Preto/dourado	1008537	251,00



E27 | 8W | 330°  
1900K | 400lm | CEE=F  
6kWh/1000h



Art. N.º: 1008159 | 89,00 EUR

165410

318



165400

319



165390

319

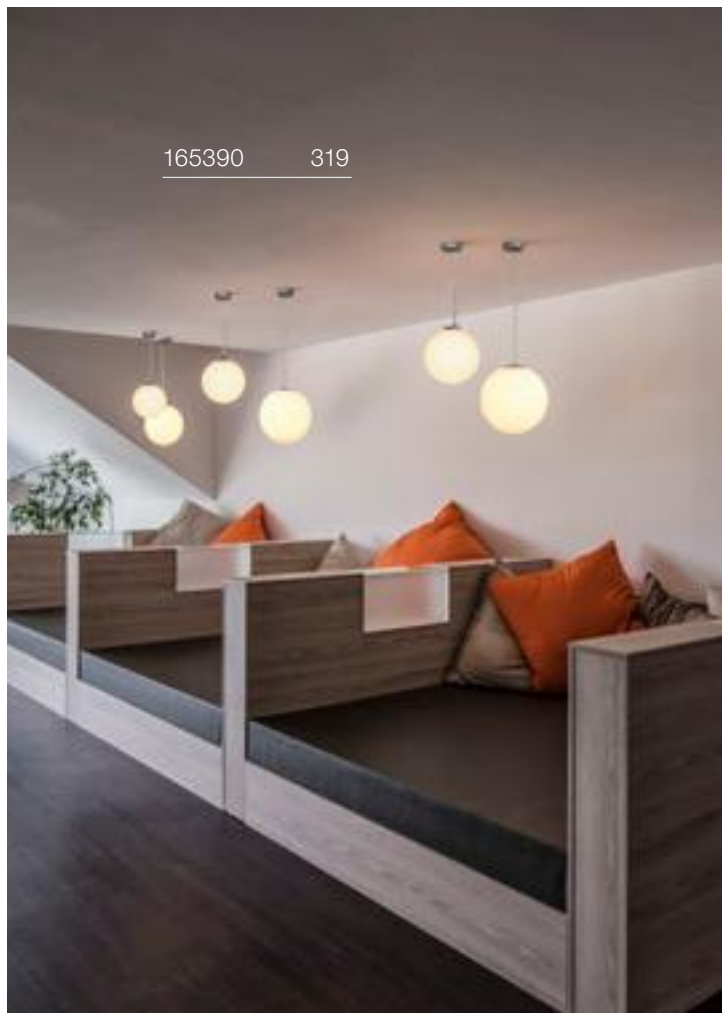



## ROTOBALL 25 PD, E27

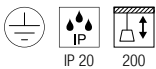
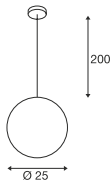

220-240V ~50/60Hz  
Material: aço/polietileno (PE)



Casquilho: 1xE27

Máx. Ø: 7 cm

Versão	Art. n.º	EUR
○ Branco	165390	161,00



LED E27 | 13,2W | 220°  
2700K | 1300lm | CEE=F  
13kWh/1000h



Art. N.º: 1005302 | 12,25 EUR

## ROTOBALL 40 PD, E27

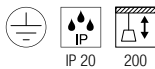
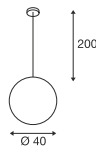

220-240V ~50/60Hz  
Material: aço/polietileno (PE)



Casquilho: 1xE27

Máx. Ø: 9,5 cm

Versão	Art. n.º	EUR
○ Branco	165410	181,00



LED E27 | 13,2W | 220°  
2700K | 1300lm | CEE=F  
13kWh/1000h



Art. N.º: 1005302 | 12,25 EUR

## ROTOBALL 50 PD, E27

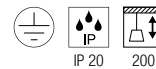
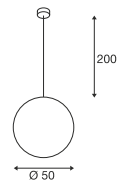

220-240V ~50/60Hz  
Material: aço/polietileno (PE)



Casquilho: 1xE27

Máx. Ø: 9,5 cm

Versão	Art. n.º	EUR
○ Branco	165400	222,00



LED E27 | 13,2W | 220°  
2700K | 1300lm | CEE=F  
13kWh/1000h



Art. N.º: 1005302 | 12,25 EUR

## PARA DOME PD, E27

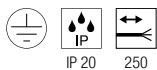
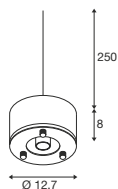

220-240V ~50/60Hz  
Material: alumínio

- Extremidade do cabo aberta

**SECRET INSIDE** <150 W

Casquilho: 1xE27 Máx. Ø: 7 cm

Versão	Art. n.º	EUR
● Preto	1005214	82,00
● Cinzento	1005215	82,00



LED E27 | 11W | 330°  
2700K | 1250lm | CEE=E  
11kWh/1000h



Art. N.º: 1008162 | 84,00 EUR



Artigo	Art. n.º	EUR
Adaptador para calha eletrificada monof.		
● Preto	143120	15,00
Adaptador para calha eletrificada trif.		
● Preto	145990	19,70
Roseta saliente para teto		
● Preto	1004744	34,00
Roseta para encastrar no teto		
● Preto	1004674	22,50
Roseta para teto		
● Preto	210060	32,00
FITU 1.ª roseta para teto		
● Preto	132600	26,00

## PARA DOME Abajur



IP 20

A: 20,6 cm  
Ø: 30,8 cm  
Material: alumínio

Versão	Art. n.º	EUR
● Preto	1005216	100,00
● Preto/dourado	1006410	100,00
● Cinzento	1005217	100,00

## PARA DOME Abajur



IP 20

A: 20 cm  
Ø: 31,5 cm  
Material: policarbonato (PC)

Versão	Art. n.º	EUR
○ Transparente	1005218	100,00







PARA 380  
PD, E27

165359 321

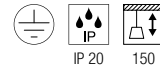
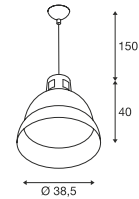

220-240V ~50/60Hz  
Material: alumínio

**SOCKET**  
**INSIDE** <20  
W

Casquilho: 1xE27

Versão	Art. n.º	EUR
● Preto	165359	165,00



LED E27 | 13,2W | 220°  
2700K | 1300lm | CEE=F  
13kWh/1000h



Art. N.º: 1005302 | 12,25 EUR



NEW

LED  
QUIMERA | 329



LED  
LYGANT | 331



LED  
LYGANT | 331



NEW

SCKET  
VARYT | 333



NEW

VARYT | 333

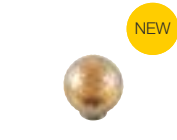

NEW

VARYT | 333



NEW

VARYT | 333



NEW

VARYT | 333



NEW

SCKET  
SUN | 334

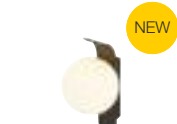

NEW

SCKET  
SUN | 335



LED  
NUMINOS® S | 336



LED  
NUMINOS® M | 338



LED  
NUMINOS® L | 340



LED  
NUMINOS® XL | 342



LED  
MEDO® PRO 30 | 344



LED  
MEDO® PRO 40 | 345



LED  
MEDO® PRO 60 | 346



LED  
MEDO® PRO 90 | 347



LED  
MEDO® PRO 30 | 348



LED  
MEDO® PRO 40 | 349



LED  
MEDO® PRO 60 | 350



LED  
MEDO® PRO 90 | 351



LED  
MEDO® 30 | 352



LED  
MEDO® 40 | 352



LED  
MEDO® 60 | 353



LED  
MEDO® 90 | 353



NEW

LED  
ONE LINEAR 50 | 354



NEW

LED  
ONE LINEAR 70 | 355



LED  
ONE 40 | 357



LED  
ONE 60 | 357



LED  
TRUKKO | 358



LED  
TRUKKO | 358



LED  
TRUKKO | 359



LED  
TRUKKO 60 | 359



LED  
TRUKKO 90 | 359



LED  
SEDO 14 | 360



LED  
SEDO 21 | 360



LED  
ARLINA 60 | 361



LED  
ARLINA 130 | 361



LED  
MARYLIN 40 | 363



LED  
MARYLIN 60 | 363



LED  
MARYLIN 90 | 363



**SCKET**

WL 106 | 364



**SCKET**

WL 106 | 364



**SCKET**

MIBO UP/DOWN | 365



**LED**

MAGANDA | 365



**LED**

DORISA 30 | 367



**LED**

DORISA 50 | 367



**LED**

DORISA 60 | 367



**LED**

Q-LINE® | 368



**LED**

L-LINE 60 | 369



**LED**

L-LINE 120 | 369



**SCKET**

PANTILO ROPE | 373



**SCKET**

ASTO TUBE | 375



**SCKET**

ASTO TUBE | 375



**LED**

MANA BASE | 377



MANA BASE | 378



MANA 40 | 378



MANA 60 | 378



MANA 40 | 379

NEW



NEW

MANA 40 | 379



NEW

MANA 40 | 379



NEW

MANA 60 | 379



NEW

MANA 60 | 379



NEW

MANA 60 | 379



MANA | 381



MANA | 381



**LED**

MANA | 383



MANA | 383



**LED**

OCULUS | 385



**LED**

OCULUS | 385



**LED**

OCULUS | 385

NEW



**SCKET**

PLASTRA | 386



**SCKET**

PLASTRA | 386



**SCKET**

PLASTRA | 387



**SCKET**

PLASTRA | 387



**SCKET**

PLASTRA | 389



**LED**

PLASTRA | 389



**LED**

PLASTRA | 389



**SCKET**

PLASTRA | 390



**SCKET**

PLASTRA 101 | 391



**SCKET**

PLASTRA | 391



**SCKET**

PLASTRA 104 | 391



**LED**

LOGS IN | 392



LED  
LOGS IN | 392



LED  
LOGS IN L | 393



LED  
LOGS IN L | 393



LED  
QUAD FRAME 14 | 395



LED  
QUAD FRAME 19 | 395

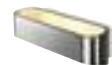

LED  
ASSO 300 | 396



LED  
ASSO 300 | 397



SCKET  
OSSA 180 | 397



SCKET  
ASSO 300 | 397



LED  
CARISO | 398



LED  
CARISO | 398



LED  
CHROMBO | 399



LED  
DIRETO 60 | 401



LED  
DIRETO 90 | 401



SCKET  
DENA 30 | 402



SCKET  
BASKET | 402



SCKET  
QUADRASS | 403



LED  
QUADRASS  
SPOT | 403



FITU | 404



FITU CUBE | 404



SCKET  
THEO UP/DOWN | 405



SCKET  
SOLID CUBE | 405



SCKET  
ENOLA B | 407



SCKET  
ENOLA B | 407



SCKET  
ASTINA  
UP/DOWN | 407



SCKET  
FENDA | 408



FENDA | 408



LED  
KENKUA SPOT | 409



LED  
COUPA FLEX | 409



LED  
KARPO MAGN | 410



LED  
KARPO MAGN | 410



LED  
KARPO 30 | 411



LED  
KARPO | 411



LED  
SOMNILA SPOT | 412



LED  
SOMNILA SPOT | 413



LED  
SOMNILA FLEX | 413



LED  
SOMNILA FLEX | 413



SCKET  
DIO FLEX PLATE | 415



LED  
DIO FLEX PLATE | 415



PHELIA | 416

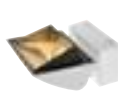



LED  
MERADO FLOOD | 416



SCKET  
DISPLAY ADL 50 | 417



 <b>LED</b> DECONA 30   418	 <b>LED</b> DECONA 42   419	 <b>SCKET</b> PURI 2.0   421	 <b>SCKET</b> PURI 2.0   421	 <b>SCKET</b> PURI 2.0   421	 <b>SCKET</b> PURI 2.0   420
 <b>SCKET</b> PURI 2.0   421	 <b>SCKET</b> PURI 2.0   421	 <b>SCKET</b> PURI 2.0   421	 <b>SCKET</b> PURI 2.0   423	 <b>SCKET</b> PURI 2.0   423	 <b>SCKET</b> PURI 2.0   423
 <b>SCKET</b> PURI 2.0   422	 <b>SCKET</b> PURI 2.0   423	 <b>SCKET</b> PURI 2.0   423	 <b>SCKET</b> PURI 2.0   423	 <b>SCKET</b> PURI 2.0   425	 <b>SCKET</b> PURI 2.0   425
 <b>SCKET</b> PURI 2.0   425	 <b>SCKET</b> PURI 2.0   424	 <b>SCKET</b> PURI 2.0   425	 <b>SCKET</b> PURI 2.0   425	 <b>SCKET</b> PURI 2.0   425	 <b>SCKET</b> PURI 2.0   427
 <b>SCKET</b> PURI 2.0   427	 <b>SCKET</b> PURI 2.0   427	 <b>SCKET</b> PURI 2.0   426	 <b>SCKET</b> PURI 2.0   427	 <b>SCKET</b> PURI 2.0   427	 <b>SCKET</b> PURI 2.0   427
 <b>SCKET</b> PURI 2.0   429	 <b>SCKET</b> PURI 2.0   429	 <b>SCKET</b> PURI 2.0   429	 <b>SCKET</b> PURI   431	 <b>SCKET</b> PURI   431	 <b>SCKET</b> PURI   431
 <b>SCKET</b> PURI   431	 <b>SCKET</b> AVO   433	 <b>SCKET</b> AVO   433	 <b>SCKET</b> AVO   433	 <b>SCKET</b> AVO   433	 <b>SCKET</b> ASTO   435



**SCKET**  
ASTO | 435



**SCKET**  
ASTO | 435



**SCKET**  
ASTO | 435



**SCKET**  
PANTILO  
ROPE 19 | 437



**SCKET**  
PANTILO  
ROPE 27 | 437



**LED**  
CYFT WAVE | 439



**LED**  
CYFT | 439



NEW

**SCKET**  
KAMI | 441



**SCKET**  
ASTO TUBE | 443



**SCKET**  
ASTO TUBE | 443



**SCKET**  
ASTO TUBE | 443



**SCKET**  
ASTO TUBE | 443



**LED**  
OCULUS | 445



**LED**  
KARPO 30 | 445



NEW

**LED**  
NOBLO® | 447



NEW

**LED**  
NOBLO® | 447



NEW

**LED**  
NOBLO® | 447



NEW

**LED**  
NOBLO® | 449



NEW

**LED**  
NOBLO® | 449



NEW

**LED**  
NOBLO® | 449



**LED**  
KALU | 451



**LED**  
KALU | 451



**LED**  
KALU | 451



**LED**  
KALU | 451



**SCKET**  
KALU | 453



**SCKET**  
KALU | 453



**SCKET**  
KALU | 453



**SCKET**  
KALU | 453



**SCKET**  
ENOLA B | 455



**SCKET**  
ENOLA B | 455



**SCKET**  
ENOLA B | 455



**SCKET**  
ALTRA DICE | 456



**LED**  
SPOT 79 | 457



**LED**  
INDA 12 | 457



**LED**  
SENSER 12 | 459



**LED**  
SENSER 18 | 459

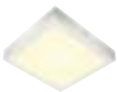

**LED**  
SENSER 24 | 459



**LED**  
SENSER 12 | 461



**LED**  
SENSER 18 | 461



**LED**  
SENSER 24 | 461



**LED**  
SIMA | 462



**LED**  
SIMA | 462



**LED**  
SIMA | 463

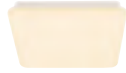

**LED**  
SIMA | 463



**LED**  
LIPSY® 30 | 465



**LED**  
LIPSY® 40 | 465



**LED**  
LIPSY® 50 | 465



**LED**  
LIPSY® 30 | 467



**LED**  
LIPSY® 40 | 467



**LED**  
LIPSY® 50 | 467



**LED**  
LIPSY® 40 | 468



**LED**  
LIPSY® 50 | 468



**SOCKET**  
MELAN | 469



**LED**  
BATTEN 60 | 471



**LED**  
BATTEN 120 | 471



**LED**  
LONG GRILL | 473



**LED**  
SIGHT 60 | 475



**LED**  
SIGHT 115 | 475

1008036 329







## QUIMERA WL, PHASE

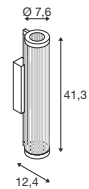

IP20 IK03 350° L80B50

220-240V ~50/60Hz | 700mA

Potência do sistema: 8,2W

Material: alumínio/vidro



Down 320lm | 2700K | 330lm | 3000K

Versão	Art. n.º	EUR
● Latão (PVD)	<b>1008036</b>	<b>359,00</b>
● Cobre escuro (PVD)	<b>1008037</b>	<b>359,00</b>
● Bronze escuro (PVD)	<b>1008035</b>	<b>359,00</b>





### LYGANT WL, single

### LYGANT WL, double

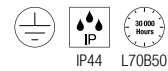
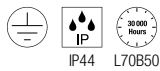
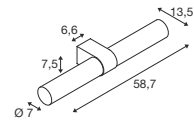
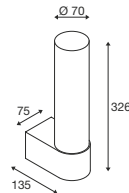

220-240V ~50/60Hz | 700mA  
Potência do sistema: 8W  
Material: alumínio

220-240V ~50/60Hz | 500mA  
Potência do sistema: 11W  
Material: alumínio



Down 560lm | 3000K

Down 800lm | 3000K

Versão	Art. n.º	EUR
● Preto	1007614	249,00
○ Branco	1007613	249,00
● Latão (PVD)	1007612	279,00
● Cromado	1007615	279,00

Versão	Art. n.º	EUR
● Preto	1007618	359,00
○ Branco	1007617	359,00
● Latão (PVD)	1007616	385,00
● Cromado	1007619	385,00



1008107 + 1007859 333



1008105 + 1007860 333



## VARYT



NEW

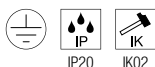
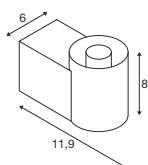

220-240V ~50/60Hz  
Material: aço



Casquilho: 1xE14 máx. Ø: 7 cm C: 3,8 cm

Versão	Art. n.º	EUR
● Preto	1008104	89,00
○ Branco	1008105	89,00
● Latão (PVD)	1008107	119,00
● Cromado	1008106	99,00
● Cobre (PVD)	1008108	119,00

## VARYT

Difusor em vidro p/ PD, WL, CL, TL

MIX match



NEW



IK02

A: 12,8 cm  
Ø: 12 cm  
Material: vidro

Versão	Art. n.º	EUR
○ Branco	1008119	59,00

## VARYT

Difusor em vidro diamante p/ PD, WL, CL, TL

MIX match

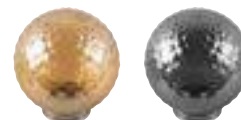

NEW



IK02

A: 12,7 cm  
Ø: 12 cm  
Material: vidro

Versão	Art. n.º	EUR
● Âmbar	1008023	79,00
● Smoke	1007858	79,00

## VARYT

Difusor em vidro linha p/ PD, WL, CL, TL

MIX match



NEW



IK02

A: 13 cm  
Ø: 12 cm  
Material: vidro

Versão	Art. n.º	EUR
○ Branco	1007859	69,00

## VARYT

Difusor em vidro plissado p/ PD, WL, CL, TL

MIX match



NEW



IK02

A: 13,5 cm  
Ø: 11,5 cm  
Material: vidro

Versão	Art. n.º	EUR
○ Branco	1007860	75,00

# SUN WL, G9 Quadrado

NEW



1008123 334

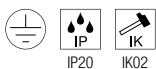
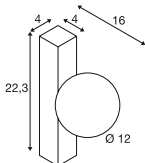

220-240V ~50/60Hz  
Material: vidro



Casquilho: 1xG9 máx. Ø: 1,9 cm C: 6 cm

Versão	Art. n.º	EUR
● Preto	1008123	● 109,00



G9 | 3,6W | 300°  
3000K | 400lm | CEE=E  
4kWh/1000h



Art. N.º: 1005286 | 8,80 EUR



## SUN WL, G9 arredondado

NEW



1008124 335

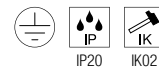
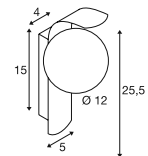

220-240V ~50/60Hz  
Material: vidro

**SOCKET**  
**INSIDE** 40 W

Casquinho: 1xG9 máx. Ø: 1,9 cm | C: 6 cm

Versão	Art. n.º	EUR
● Preto	1008124	● 109,00



LED QT14 | 3,6W | 300°  
2700K | 450lm | CEE=E  
4kWh/1000h



Art. N.º: 1007455 | 8,80 EUR

NUMINOS® S  
CW

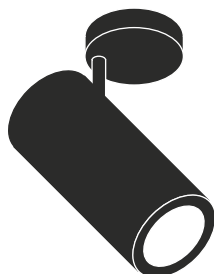

● Preto

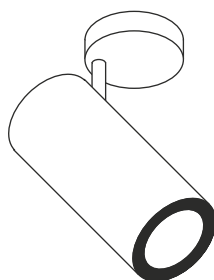
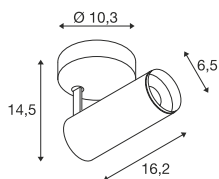

○ Branco



200mA  
220-240V ~50/60Hz  
Potência do sistema: 8,6W  
Material: alumínio/policarbonato (PC)

Versão	EUR
Versões S	115,00
Versões S DALI	165,00











**Nota:**  
Anel decorativo também disponível em branco, dourado e cobre



Versão	Art. n.º	EUR
Anel frontal S		
○ Branco	1006167	1,30
Anel frontal S		
● Dourado	1008144	8,00
Anel frontal S		
● Cobre	1008140	8,00





				UGR	Art. N.º	
	2700K	930lm	24°	16	<b>1004098</b>	
		944lm	36°	16	<b>1004099</b>	
		960lm	60°	19	<b>1004100</b>	
	3000K	1016lm	24°	13	<b>1004106</b>	
		1037lm	36°	13	<b>1004107</b>	
		1042lm	60°	19	<b>1004108</b>	
	4000K	1074lm	24°	16	<b>1004114</b>	
		1092lm	36°	16	<b>1004115</b>	
		1098lm	60°	19	<b>1004116</b>	
	2700K	930lm	24°	16	<b>1004386</b>	
		944lm	36°	16	<b>1004387</b>	
		960lm	60°	19	<b>1004388</b>	
	3000K	1016lm	24°	13	<b>1004394</b>	
		1037lm	36°	13	<b>1004395</b>	
		1042lm	60°	19	<b>1004396</b>	
	4000K	1074lm	24°	16	<b>1004402</b>	
		1092lm	36°	16	<b>1004403</b>	
		1098lm	60°	19	<b>1004404</b>	
	2700K	930lm	24°	16	<b>1004102</b>	
		944lm	36°	16	<b>1004103</b>	
		960lm	60°	19	<b>1004104</b>	
	3000K	1016lm	24°	13	<b>1004110</b>	
		1037lm	36°	13	<b>1004111</b>	
		1042lm	60°	19	<b>1004112</b>	
	4000K	1074lm	24°	16	<b>1004118</b>	
		1092lm	36°	16	<b>1004119</b>	
		1098lm	60°	19	<b>1004120</b>	
	2700K	930lm	24°	16	<b>1004390</b>	
		944lm	36°	16	<b>1004391</b>	
		960lm	60°	19	<b>1004392</b>	
	3000K	1016lm	24°	13	<b>1004398</b>	
		1037lm	36°	13	<b>1004399</b>	
		1042lm	60°	19	<b>1004400</b>	
	4000K	1074lm	24°	16	<b>1004406</b>	
		1092lm	36°	16	<b>1004407</b>	
		1098lm	60°	19	<b>1004408</b>	

NUMINOS® M  
CW

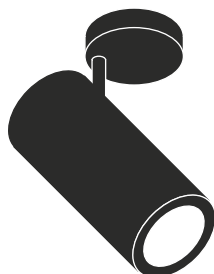

● Preto

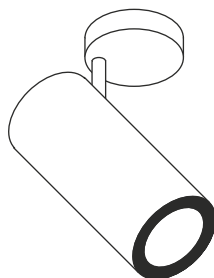
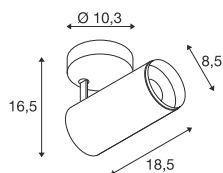

○ Branco



350mA  
220-240V ~50/60Hz  
Potência do sistema: 14W  
Material: alumínio/policarbonato (PC)











Versão	EUR
Versões M	145,00
Versões M DALI	197,00

**Nota:**  
Anel decorativo também disponível em branco, dourado e cobre



Versão	Art. n.º	EUR
Anel frontal M		
○ Branco	1006168	2,40
Anel frontal M		
● Dourado	1008145	9,00
Anel frontal M		
● Cobre	1008141	9,00



				UGR	Art. N.º	
	2700K	1750lm	24°	16	<b>1004194</b>	
		1744lm	36°	16	<b>1004195</b>	
		1697lm	60°	22	<b>1004196</b>	
	3000K	1804lm	24°	16	<b>1004202</b>	
		1790lm	36°	13	<b>1004203</b>	
		1749lm	60°	22	<b>1004204</b>	
	4000K	1931lm	24°	19	<b>1004210</b>	
		1927lm	36°	16	<b>1004211</b>	
		1872lm	60°	25	<b>1004212</b>	
	2700K	1750lm	24°	16	<b>1004482</b>	
		1744lm	36°	16	<b>1004483</b>	
		1697lm	60°	22	<b>1004484</b>	
	3000K	1804lm	24°	16	<b>1004490</b>	
		1790lm	36°	13	<b>1004491</b>	
		1749lm	60°	22	<b>1004492</b>	
	4000K	1931lm	24°	19	<b>1004498</b>	
		1927lm	36°	16	<b>1004499</b>	
		1872lm	60°	25	<b>1004500</b>	
	2700K	1750lm	24°	16	<b>1004198</b>	
		1744lm	36°	16	<b>1004199</b>	
		1697lm	60°	22	<b>1004200</b>	
	3000K	1804lm	24°	16	<b>1004206</b>	
		1790lm	36°	13	<b>1004207</b>	
		1749lm	60°	22	<b>1004208</b>	
	4000K	1931lm	24°	19	<b>1004214</b>	
		1927lm	36°	16	<b>1004215</b>	
		1872lm	60°	25	<b>1004216</b>	
	2700K	1750lm	24°	16	<b>1004486</b>	
		1744lm	36°	16	<b>1004487</b>	
		1697lm	60°	22	<b>1004488</b>	
	3000K	1804lm	24°	16	<b>1004494</b>	
		1790lm	36°	13	<b>1004495</b>	
		1749lm	60°	22	<b>1004496</b>	
	4000K	1931lm	24°	19	<b>1004502</b>	
		1927lm	36°	16	<b>1004503</b>	
		1872lm	60°	25	<b>1004504</b>	

NUMINOS® L  
CW

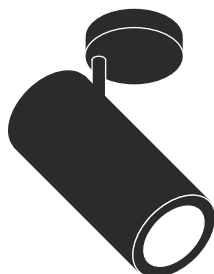

● Preto

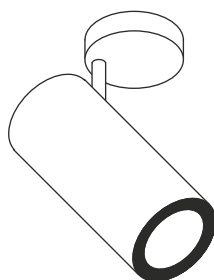
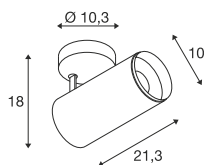

○ Branco



500mA  
220-240V ~50/60Hz  
Potência do sistema: 19W  
Material: alumínio/policarbonato (PC)











Versão	EUR
Versões L	155,00
Versões L DALI	215,00

**Nota:**  
Anel decorativo também disponível em branco, dourado e cobre



Versão	Art. n.º	EUR
Anel frontal L		
○ Branco	1006169	2,40
Anel frontal L		
● Dourado	1008146	10,00
Anel frontal L		
● Cobre	1008142	10,00



				UGR	Art. N.º	
	2700K	2370lm	24°	19	<b>1004290</b>	
		2245lm	36°	19	<b>1004291</b>	
		2304lm	60°	22	<b>1004292</b>	
	3000K	2432lm	24°	13	<b>1004298</b>	
		2320lm	36°	13	<b>1004299</b>	
		2373lm	60°	22	<b>1004300</b>	
	4000K	2694lm	24°	19	<b>1004306</b>	
		2557lm	36°	19	<b>1004307</b>	
		2601lm	60°	22	<b>1004308</b>	
	2700K	2370lm	24°	19	<b>1004578</b>	
		2245lm	36°	19	<b>1004579</b>	
		2304lm	60°	22	<b>1004580</b>	
	3000K	2432lm	24°	13	<b>1004586</b>	
		2320lm	36°	13	<b>1004587</b>	
		2373lm	60°	22	<b>1004588</b>	
	4000K	2694lm	24°	19	<b>1004594</b>	
		2557lm	36°	19	<b>1004595</b>	
		2601lm	60°	22	<b>1004596</b>	
	2700K	2370lm	24°	19	<b>1004294</b>	
		2245lm	36°	19	<b>1004295</b>	
		2304lm	60°	22	<b>1004296</b>	
	3000K	2432lm	24°	13	<b>1004302</b>	
		2320lm	36°	13	<b>1004303</b>	
		2373lm	60°	22	<b>1004304</b>	
	4000K	2694lm	24°	19	<b>1004310</b>	
		2557lm	36°	19	<b>1004311</b>	
		2601lm	60°	22	<b>1004312</b>	
	2700K	2370lm	24°	19	<b>1004582</b>	
		2245lm	36°	19	<b>1004583</b>	
		2304lm	60°	22	<b>1004584</b>	
	3000K	2432lm	24°	13	<b>1004590</b>	
		2320lm	36°	13	<b>1004591</b>	
		2373lm	60°	22	<b>1004592</b>	
	4000K	2694lm	24°	19	<b>1004598</b>	
		2557lm	36°	19	<b>1004599</b>	
		2601lm	60°	22	<b>1004600</b>	

# NUMINOS® XL CW

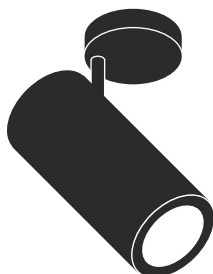

● Preto

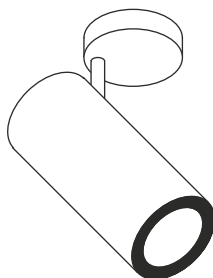
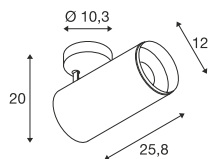

○ Branco



700mA  
220-240V ~50/60Hz  
Potência do sistema: 26W  
Material: alumínio/policarbonato (PC)











Versão	EUR
Versões XL	165,00
Versões XL DALI	235,00

**Nota:**  
Anel decorativo também disponível em branco, dourado e cobre



Versão	Art. n.º	EUR
Anel frontal XL		
○ Branco	1006170	3,55
Anel frontal XL		
● Dourado	1008147	11,00
Anel frontal XL		
● Cobre	1008143	11,00



				UGR	Art. N.º	
	2700K	3566lm	24°	19	<b>1006083</b>	
		3542lm	36°	19	<b>1006084</b>	
		3152lm	60°	25	<b>1006085</b>	
	3000K	3586lm	24°	19	<b>1006089</b>	
		3536lm	36°	19	<b>1006090</b>	
		3135lm	60°	25	<b>1006091</b>	
	4000K	3891lm	24°	19	<b>1006095</b>	
		3840lm	36°	19	<b>1006096</b>	
		3438lm	60°	25	<b>1006097</b>	
	2700K	3566lm	24°	19	<b>1005741</b>	
		3542lm	36°	19	<b>1005742</b>	
		3152lm	60°	25	<b>1005743</b>	
	3000K	3586lm	24°	19	<b>1005747</b>	
		3536lm	36°	19	<b>1005748</b>	
		3135lm	60°	25	<b>1005749</b>	
	4000K	3891lm	24°	19	<b>1005753</b>	
		3840lm	36°	19	<b>1005754</b>	
		3438lm	60°	25	<b>1005755</b>	
	2700K	3566lm	24°	19	<b>1006086</b>	
		3542lm	36°	19	<b>1006087</b>	
		3152lm	60°	25	<b>1006088</b>	
	3000K	3586lm	24°	19	<b>1006092</b>	
		3536lm	36°	19	<b>1006093</b>	
		3135lm	60°	25	<b>1006094</b>	
	4000K	3891lm	24°	19	<b>1006098</b>	
		3840lm	36°	19	<b>1006099</b>	
		3438lm	60°	25	<b>1006100</b>	
	2700K	3566lm	24°	19	<b>1005744</b>	
		3542lm	36°	19	<b>1005745</b>	
		3152lm	60°	25	<b>1005746</b>	
	3000K	3586lm	24°	19	<b>1005750</b>	
		3536lm	36°	19	<b>1005751</b>	
		3135lm	60°	25	<b>1005752</b>	
	4000K	3891lm	24°	19	<b>1005756</b>	
		3840lm	36°	19	<b>1005757</b>	
		3438lm	60°	25	<b>1005758</b>	

MEDO® PRO 30  
CW, DALI, UGR<19

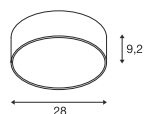

220-240V ~50/60Hz | 250mA  
Potência do sistema: 10W  
Material: alumínio/aço

- Também disponível na Versão DC (a pedido)



Down 1250lm | 3000K | 1250lm | 4000K

Versão	Art. n.º	EUR
● Preto	1007284	329,00
○ Branco	1007285	329,00



Artigo	Art. n.º	EUR
kit de suspensão 1,5 m		
● Preto	135250	44,75
○ Branco	135251	44,75
kit de suspensão 5 m		
● Preto	1001952	99,00
○ Branco	1001950	99,00

MEDO® PRO 30  
CW, PHASE, UGR<19

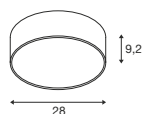

220-240V ~50/60Hz | 250mA  
Potência do sistema: 10W  
Material: alumínio/aço

- Também disponível na Versão DC (a pedido)



Down 1250lm | 3000K | 1250lm | 4000K

Versão	Art. n.º	EUR
● Preto	1007288	299,00
○ Branco	1007289	299,00



Artigo	Art. n.º	EUR
kit de suspensão 1,5 m		
● Preto	135250	44,75
○ Branco	135251	44,75
kit de suspensão 5 m		
● Preto	1001952	99,00
○ Branco	1001950	99,00







MEDO® PRO 40  
CW, DALI, UGR<19

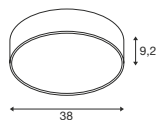

220-240V ~50/60Hz | 500mA  
Potência do sistema: 19W  
Material: alumínio/aço

- Também disponível na Versão DC (a pedido)



Down 2400lm | 3000K | 2500lm | 4000K

Versão	Art. n.º	EUR
● Preto	1007292	399,00
○ Branco	1007293	399,00



Artigo	Art. n.º	EUR
kit de suspensão 1,5 m		
● Preto	135250	44,75
○ Branco	135251	44,75
kit de suspensão 5 m		
● Preto	1001952	99,00
○ Branco	1001950	99,00

MEDO® PRO 40  
CW, PHASE, UGR<19

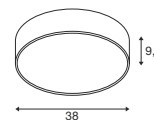

220-240V ~50/60Hz | 500mA  
Potência do sistema: 19W  
Material: alumínio/aço

- Também disponível na Versão DC (a pedido)



Down 2400lm | 3000K | 2500lm | 4000K

Versão	Art. n.º	EUR
● Preto	1007296	349,00
○ Branco	1007297	349,00



Artigo	Art. n.º	EUR
kit de suspensão 1,5 m		
● Preto	135250	44,75
○ Branco	135251	44,75
kit de suspensão 5 m		
● Preto	1001952	99,00
○ Branco	1001950	99,00

1007284 344

MEDO® PRO 60  
CW, DALI, UGR<19

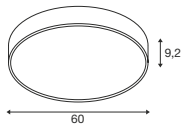

220-240V ~50/60Hz | 1000mA  
Potência do sistema: 39W  
Material: alumínio/aço

- Também disponível na Versão DC (a pedido)



Down 5000lm | 3000K | 5100lm | 4000K

Versão	Art. n.º	EUR
● Preto	1007300	699,00
○ Branco	1007301	699,00



Artigo	Art. n.º	EUR
kit de suspensão 1,5 m		
● Preto	135250	44,75
○ Branco	135251	44,75
kit de suspensão 5 m		
● Preto	1001952	99,00
○ Branco	1001950	99,00

MEDO® PRO 60  
CW, PHASE, UGR<19

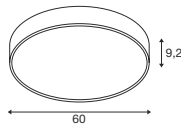

220-240V ~50/60Hz | 1000mA  
Desempenho do sistema: 37W  
Material: alumínio/aço

- Também disponível na Versão DC (a pedido)



Down 5000lm | 3000K | 5100lm | 4000K

Versão	Art. n.º	EUR
● Preto	1007304	629,00
○ Branco	1007305	629,00



Artigo	Art. n.º	EUR
kit de suspensão 1,5 m		
● Preto	135250	44,75
○ Branco	135251	44,75
kit de suspensão 5 m		
● Preto	1001952	99,00
○ Branco	1001950	99,00





MEDO® PRO 90  
CW, DALI, UGR<19

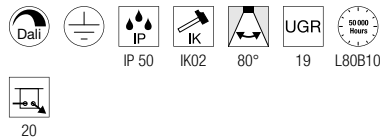
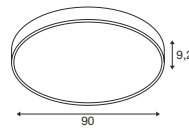

220-240V ~50/60Hz | 1000mA  
Potência do sistema: 75W  
Material: alumínio/aço

- Também disponível na Versão DC (a pedido)



Down 9400lm | 3000K | 9700lm | 4000K

Versão	Art. n.º	EUR
● Preto	1007308	1.399,00
○ Branco	1007309	1.399,00



Artigo	Art. n.º	EUR
kit de suspensão 1,5 m		
● Preto	135250	44,75
○ Branco	135251	44,75
kit de suspensão 5 m		
● Preto	1001952	99,00
○ Branco	1001950	99,00

MEDO® PRO 90  
CW, PHASE, UGR<19

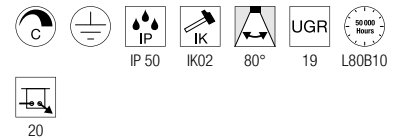
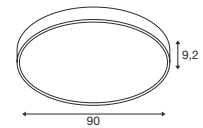

220-240V ~50/60Hz | 1000mA  
Potência do sistema: 74W  
Material: alumínio/aço

- Também disponível na Versão DC (a pedido)



Down 9400lm | 3000K | 9700lm | 4000K

Versão	Art. n.º	EUR
● Preto	1007312	1.249,00
○ Branco	1007313	1.249,00



Artigo	Art. n.º	EUR
kit de suspensão 1,5 m		
● Preto	135250	44,75
○ Branco	135251	44,75
kit de suspensão 5 m		
● Preto	1001952	99,00
○ Branco	1001950	99,00

MEDO® PRO 30  
CW, DALI

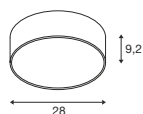

220-240V ~50/60Hz | 250mA  
Potência do sistema: 10W  
Material: alumínio/aço

- Também disponível na Versão DC (a pedido)



Down 1350lm | 3000K | 1350lm | 4000K

Versão	Art. n.º	EUR
● Preto	1007286	319,00
○ Branco	1007287	319,00



Artigo	Art. n.º	EUR
kit de suspensão 1,5 m		
● Preto	135250	44,75
○ Branco	135251	44,75
kit de suspensão 5 m		
● Preto	1001952	99,00
○ Branco	1001950	99,00

MEDO® PRO 30  
CW, PHASE

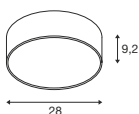

220-240V ~50/60Hz | 250mA  
Potência do sistema: 10W  
Material: alumínio/aço

- Também disponível na Versão DC (a pedido)



Down 1350lm | 3000K | 1350lm | 4000K

Versão	Art. n.º	EUR
● Preto	1007290	289,00
○ Branco	1007291	289,00



Artigo	Art. n.º	EUR
kit de suspensão 1,5 m		
● Preto	135250	44,75
○ Branco	135251	44,75
kit de suspensão 5 m		
● Preto	1001952	99,00
○ Branco	1001950	99,00



1007295 349



1007290 348



MEDO® PRO 40  
CW, DALI

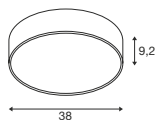

220-240V ~50/60Hz | 500mA  
Potência do sistema: 19W  
Material: alumínio/aço

- Também disponível na Versão DC (a pedido)



Down 2650lm | 3000K | 2650lm | 4000K

Versão	Art. n.º	EUR
● Preto	1007294	389,00
○ Branco	1007295	389,00



Artigo	Art. n.º	EUR
kit de suspensão 1,5 m		
● Preto	135250	44,75
○ Branco	135251	44,75
kit de suspensão 5 m		
● Preto	1001952	99,00
○ Branco	1001950	99,00

MEDO® PRO 40  
CW, PHASE

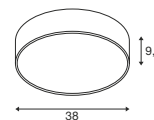

220-240V ~50/60Hz | 500mA  
Potência do sistema: 19W  
Material: alumínio/aço

- Também disponível na Versão DC (a pedido)



Down 2650lm | 3000K | 2650lm | 4000K

Versão	Art. n.º	EUR
● Preto	1007298	339,00
○ Branco	1007299	339,00



Artigo	Art. n.º	EUR
kit de suspensão 1,5 m		
● Preto	135250	44,75
○ Branco	135251	44,75
kit de suspensão 5 m		
● Preto	1001952	99,00
○ Branco	1001950	99,00



MEDO® PRO 60  
CW, DALI

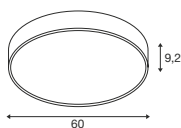

220-240V ~50/60Hz | 1000mA  
Potência do sistema: 39W  
Material: alumínio/aço

- Também disponível na Versão DC (a pedido)



Down 5450lm | 3000K | 5500lm | 4000K

Versão	Art. n.º	EUR
● Preto	1007302	679,00
○ Branco	1007303	679,00



Artigo	Art. n.º	EUR
kit de suspensão 1,5 m		
● Preto	135250	44,75
○ Branco	135251	44,75
kit de suspensão 5 m		
● Preto	1001952	99,00
○ Branco	1001950	99,00

MEDO® PRO 60  
CW, PHASE

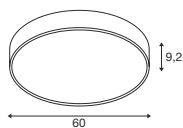

220-240V ~50/60Hz | 1000mA  
Desempenho do sistema: 37W  
Material: alumínio/aço

- Também disponível na Versão DC (a pedido)



Down 5450lm | 3000K | 5500lm | 4000K

Versão	Art. n.º	EUR
● Preto	1007306	609,00
○ Branco	1007307	609,00



Artigo	Art. n.º	EUR
kit de suspensão 1,5 m		
● Preto	135250	44,75
○ Branco	135251	44,75
kit de suspensão 5 m		
● Preto	1001952	99,00
○ Branco	1001950	99,00



1007302 350

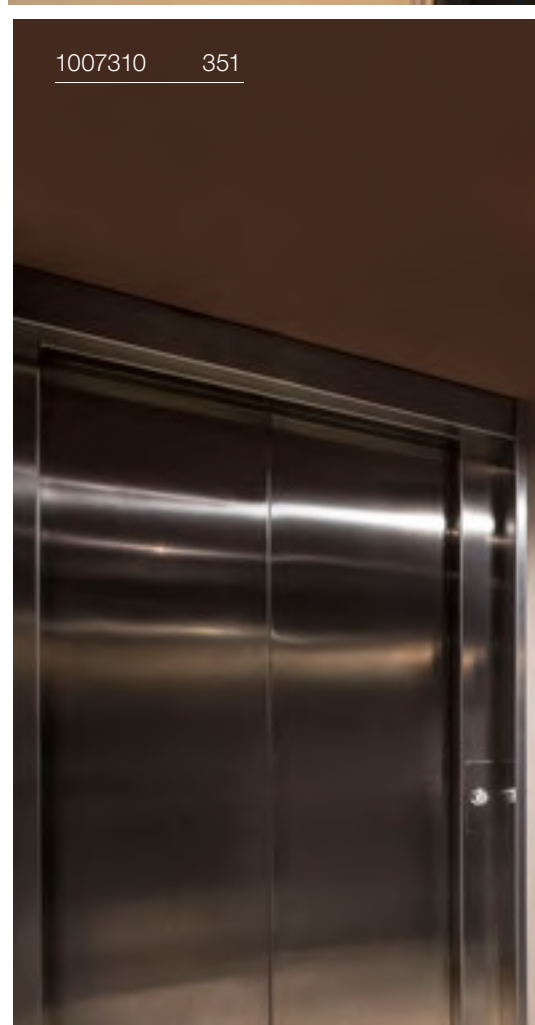

1007310 351



### MEDO® PRO 90 CW, DALI

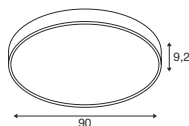

220-240V ~50/60Hz | 1000mA  
Potência do sistema: 75W  
Material: alumínio/aço

- Também disponível na Versão DC (a pedido)



Down 11000lm | 3000K | 11200lm | 4000K

Versão	Art. n.º	EUR
● Preto	1007310	1.379,00
○ Branco	1007311	1.379,00



Artigo	Art. n.º	EUR
kit de suspensão 1,5 m		
● Preto	135250	44,75
○ Branco	135251	44,75
kit de suspensão 5 m		
● Preto	1001952	99,00
○ Branco	1001950	99,00

### MEDO® PRO 90 CW, PHASE

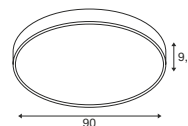

220-240V ~50/60Hz | 1000mA  
Potência do sistema: 74W  
Material: alumínio/aço

- Também disponível na Versão DC (a pedido)



Down 11000lm | 3000K | 11200lm | 4000K

Versão	Art. n.º	EUR
● Preto	1007314	1.229,00
○ Branco	1007315	1.229,00



Artigo	Art. n.º	EUR
kit de suspensão 1,5 m		
● Preto	135250	44,75
○ Branco	135251	44,75
kit de suspensão 5 m		
● Preto	1001952	99,00
○ Branco	1001950	99,00

MEDO® 30  
CW, PHASE

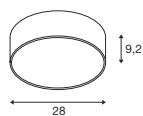

220-240V ~50/60Hz | 250mA  
Potência do sistema: 12W  
Material: alumínio/aço



1000lm | 2700K | 1050lm | 3000K | 1150lm | 4000K

Versão	Art. n.º	EUR
● Preto	1007316	249,00
○ Branco	1007317	249,00
● Cinzento	1007318	249,00



Artigo	Art. n.º	EUR
kit de suspensão 1,5 m		
● Preto	135250	44,75
○ Branco	135251	44,75
● Cinzento	135254	44,75
kit de suspensão 5 m		
● Preto	1001952	99,00
○ Branco	1001950	99,00
● Cinzento	1001951	99,00

MEDO® 40  
CW, PHASE

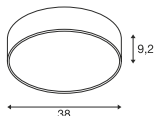

220-240V ~50/60Hz | 500mA  
Potência do sistema: 20W  
Material: alumínio/aço



2000lm | 2700K | 2100lm | 3000K | 2250lm | 4000K

Versão	Art. n.º	EUR
● Preto	1007319	279,00
○ Branco	1007320	279,00
● Cinzento	1007321	279,00



Artigo	Art. n.º	EUR
kit de suspensão 1,5 m		
● Preto	135250	44,75
○ Branco	135251	44,75
● Cinzento	135254	44,75
kit de suspensão 5 m		
● Preto	1001952	99,00
○ Branco	1001950	99,00
● Cinzento	1001951	99,00







### MEDO® 60 CW, PHASE

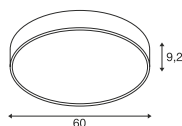

220-240V ~50/60Hz | 1000mA  
Potência do sistema: 39W  
Material: alumínio/aço



3850lm | 2700K | 4050lm | 3000K | 4300lm | 4000K

Versão	Art. n.º	EUR
● Preto	1007322	529,00
○ Branco	1007323	529,00
● Cinzento	1007324	529,00



Artigo	Art. n.º	EUR
kit de suspensão 1,5 m		
● Preto	135250	44,75
○ Branco	135251	44,75
● Cinzento	135254	44,75
kit de suspensão 5 m		
● Preto	1001952	99,00
○ Branco	1001950	99,00
● Cinzento	1001951	99,00

### MEDO® 90 CW, PHASE

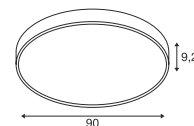

220-240V ~50/60Hz | 1000mA  
Potência do sistema: 79W  
Material: alumínio/aço



8000lm | 2700K | 8400lm | 3000K | 9000lm | 4000K

Versão	Art. n.º	EUR
● Preto	1007325	1.049,00
○ Branco	1007326	1.049,00
● Cinzento	1007327	1.049,00



Artigo	Art. n.º	EUR
kit de suspensão 1,5 m		
● Preto	135250	44,75
○ Branco	135251	44,75
● Cinzento	135254	44,75
kit de suspensão 5 m		
● Preto	1001952	99,00
○ Branco	1001950	99,00
● Cinzento	1001951	99,00

1007321 352

ONE LINEAR 50  
WL, PHASE, up/down

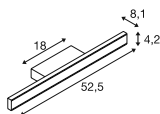

1008086 354

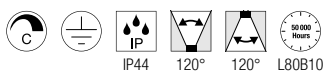

220-240V ~50/60Hz | 350mA  
Potência do sistema: 14W  
Material: alumínio/acrílico



Up 450lm | 2700K | 500lm | 3000K  
Down

Versão	Art. n.º	EUR
● Branco/Preto 3150lm   3000K	1008084	200,00
○ Branco 3350lm   4000K	1008085	200,00
● Branco/Latão 3150lm   3000K	1008086	200,00

1008081 355





## ONE LINEAR 70 WL, PHASE, up/down

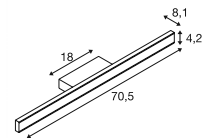

IP44 120° 120° L80B10

220-240V ~50/60Hz | 500mA

Potência do sistema: 20W

Material: alumínio/acrílico



Up	495lm	2700K	550lm	3000K
Down				

Versão	Art. n.º	EUR
● Branco/Preto 990/1100lm	<b>1008081</b>	● 240,00
○ Branco 1250/1350lm	<b>1008082</b>	● 240,00
● Branco/Latão 1250/1350lm	<b>1008083</b>	● 240,00



1002919 357





ONE 40  
CW, DALI

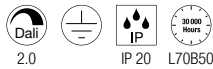
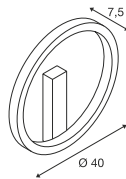

220-240V ~50/60Hz | 350mA  
Potência do sistema: 14W  
Material: alumínio/aço



Down 700lm | 3000K | 730lm | 4000K

Versão	Art. n.º	EUR
● Preto	1002915	343,00
○ Branco	1002917	343,00

ONE 60  
CW, DALI

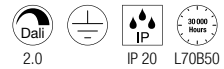
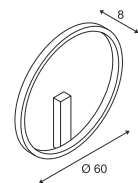

220-240V ~50/60Hz | 600mA  
Potência do sistema: 24W  
Material: alumínio/aço



Down 1350lm | 3000K | 1430lm | 4000K

Versão	Art. n.º	EUR
● Preto	1002918	413,00
○ Branco	1002919	413,00

TRUKKO  
WL, Retangular

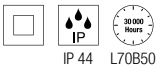

220-240V ~50/60Hz | 24V  
Potência do sistema: 25W  
Material: vidro/ABS

- Inclui aquecimento dos espelhos e função de memória
- Cor da luz regulável através de função touch



1080lm | 3000K | 1290lm | 4000K | 1250lm | 6500K

Versão	Art. n.º	EUR
○ Prateado/leitoso	<b>1004730</b>	<b>383,00</b>

TRUKKO  
WL, Redondo

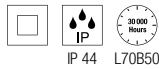

220-240V ~50/60Hz | 24V  
Potência do sistema: 25W  
Material: vidro/ABS

- Inclui aquecimento dos espelhos e função de memória
- Cor da luz regulável através de função touch



730lm | 3000K | 710lm | 4000K | 720lm | 6500K

Versão	Art. n.º	EUR
○ Prateado/leitoso 1270/1260/1260lm	<b>1004731</b>	<b>399,00</b>
● Preto 730/710/720lm	<b>1007201</b>	<b>399,00</b>

1007201 358

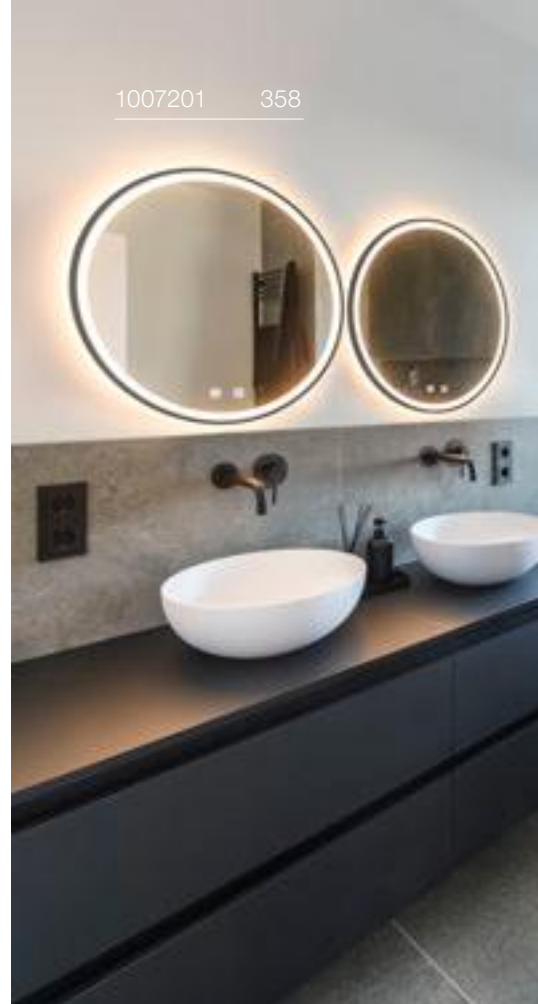

149772 359

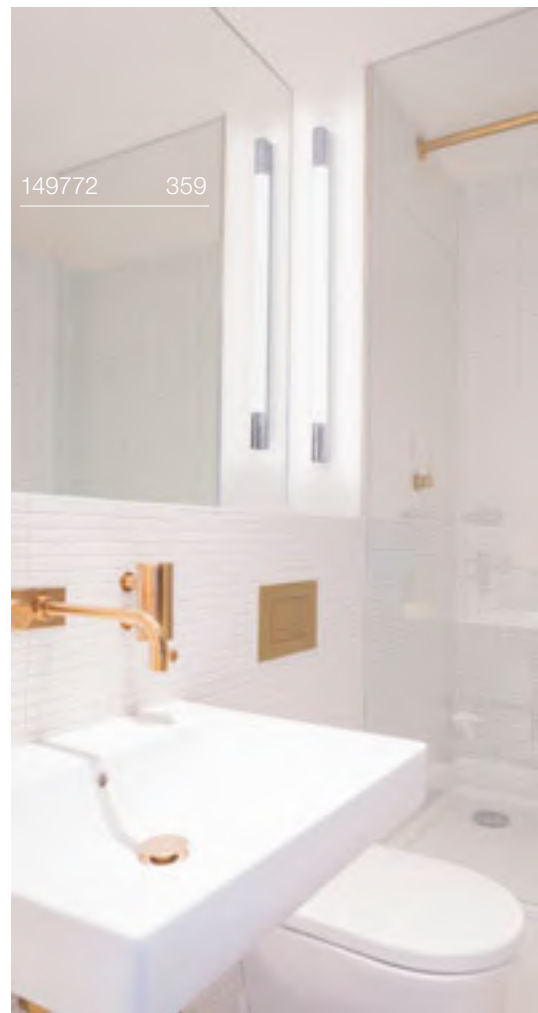



### TRUKKO 80 WL, Redondo

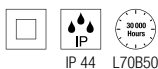
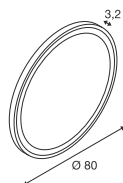
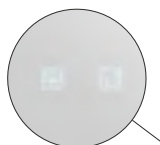

220-240V ~50/60Hz | 24V  
Potência do sistema: 23W  
Material: vidro/ABS

- Inclui aquecimento dos espelhos e função de memória
- Cor da luz regulável através de função touch



730lm | 3000K | 740lm | 4000K | 790lm | 6500K  
1100lm | 1130lm | 1210lm

Versão	Art. n.º	EUR
○ Prateado/leitoso		
1100/1130/1210lm	<b>1007200</b>	<b>560,00</b>
● Preto		
730/740/790lm	<b>1007202</b>	<b>560,00</b>

### TRUKKO 60 WL

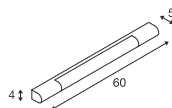

220-240V ~50/60Hz | 500mA  
Potência do sistema: 9,2W  
Material: alumínio/plástico



Down 750lm | 3000K

Versão	Art. n.º	EUR
● Cromado	<b>149762</b>	<b>161,00</b>

### TRUKKO 90 WL

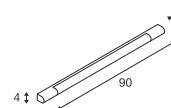

220-240V ~50/60Hz | 500mA  
Potência do sistema: 12W  
Material: alumínio/plástico



Down 1040lm | 3000K

Versão	Art. n.º	EUR
● Cromado	<b>149772</b>	<b>191,00</b>

SEDO 14  
WL

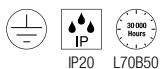
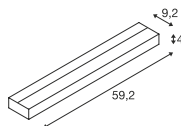

220-240V ~50/60Hz | 500mA  
Potência do sistema: 18W  
Material: alumínio/vidro



Down 1300lm | 3000K

Versão	Art. n.º	EUR
○ Branco	151781	242,00
● Alumínio	151786	252,00

SEDO 21  
WL

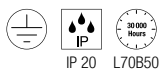
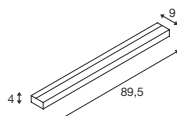

220-240V ~50/60Hz | 700mA  
Potência do sistema: 30W  
Material: alumínio/vidro



Down 2500lm | 3000K

Versão	Art. n.º	EUR
○ Branco	151791	292,00
● Alumínio	151796	302,00

151781

360

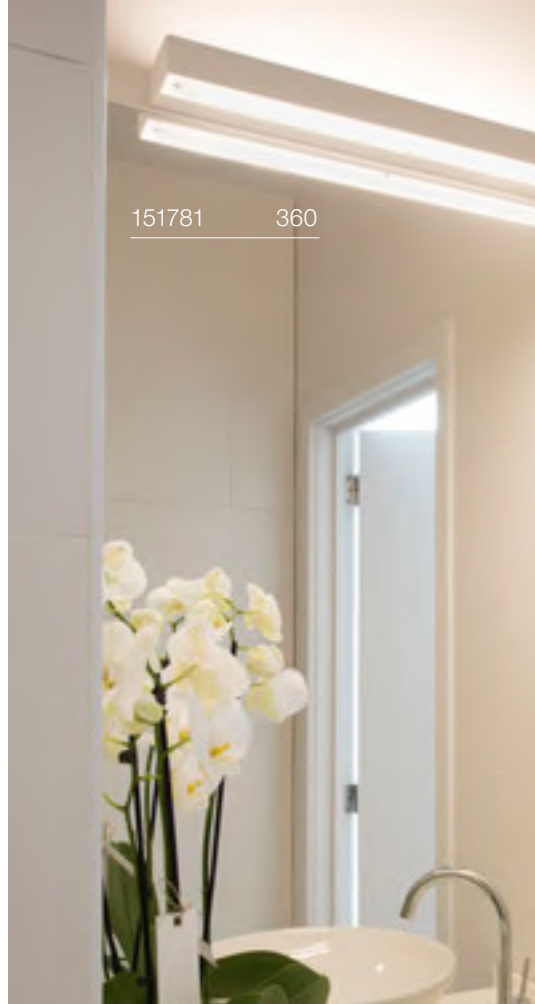





ARLINA 60  
WL

ARLINA 130  
WL

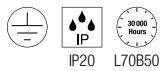
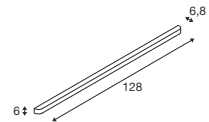
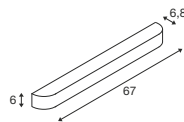

IP20 L70B50

220-240V ~50/60Hz | 500mA  
Potência do sistema: 23W  
Material: alumínio/vidro

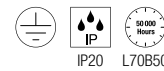

IP20 L70B50

220-240V ~50/60Hz | 700mA  
Potência do sistema: 31W  
Material: alumínio



Down 1550lm | 3000K



Down 2400lm | 3000K

Versão	Art. n.º	EUR
● Alumínio	1002239	253,00

Versão	Art. n.º	EUR
● Alumínio	1002240	325,00

1002239 361



1002191 363





### MARYLIN 40 WL

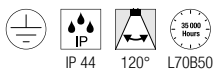
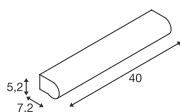

220-240V ~50/60Hz | 350mA  
Potência do sistema: 9,8W  
Material: alumínio/policarbonato (PC)



Down 890lm | 3000K | 980lm | 4000K

Versão	Art. n.º	EUR
● Cromado	1002190	228,00

### MARYLIN 60 WL

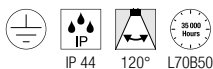
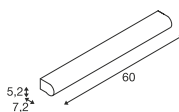

200-240V ~50/60Hz | 350mA  
Potência do sistema: 16W  
Material: alumínio/policarbonato (PC)



Down 1170lm | 3000K | 1280lm | 4000K

Versão	Art. n.º	EUR
● Cromado	1002191	286,00

### MARYLIN 90 WL

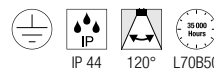
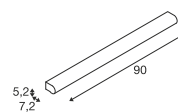

220-240V ~50/60Hz | 600mA  
Potência do sistema: 21W  
Material: alumínio/policarbonato (PC)



Down 1800lm | 3000K | 1990lm | 4000K

Versão	Art. n.º	EUR
● Cromado	1002192	344,00

WL 106  
E14

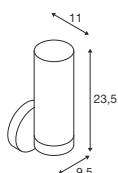

220-240V ~50/60Hz  
Material: alumínio/vidro

**SOCKET**  
**INSIDE** <40  
W

Casquilha: 1xE14 Máx. Ø: 3,6 cm C: 11 cm

Versão	Art. n.º	EUR
● ○ Cromado/branco	<b>1002228</b>	<b>90,00</b>



C35 | 4,2W | 320°  
2700K | 350lm | CEE=G  
5kWh/1000h



Art. N.º: **1005285** | **8,50 EUR**

WL 106  
E14

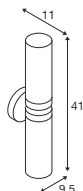

220-240V ~50/60Hz  
Material: alumínio/vidro

**SOCKET**  
**INSIDE** <40  
W

Casquilha: 2xE14 Máx. Ø: 3,6 cm C: 11 cm

Versão	Art. n.º	EUR
● Cromado	<b>1002229</b>	<b>161,00</b>



C35 | 4,2W | 320°  
2700K | 350lm | CEE=G  
5kWh/1000h



Art. N.º: **1005285** | **8,50 EUR**



1002228 364



### MIBO UP/DOWN WL, QT14

151282 365

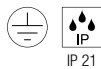
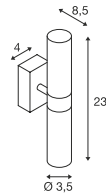

220-240V ~50/60Hz  
Material: alumínio/vidro



Casquilho: 2xG9

Versão	Art. n.º	EUR
● Cromado	151282	89,00



LED G9 | 3,6W | 300°  
3000K | 400lm | CEE=E  
4kWh/1000h

Art. N.º: 1005286 | 8,80 EUR

### MAGANDA WL

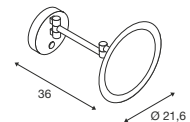

100-240V ~50/60Hz | 12V  
Potência do sistema: 4,8W  
Material: aço/vidro

- Cor da luz regulável através de interruptor na luminária



45.4lm | 2700K | 48lm | 3000K | 51lm | 4000K

Versão	Art. n.º	EUR
● Cromado	1004971	199,00

1003507 367





### DORISA 30 WL

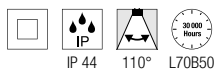
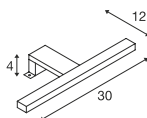

200-240V ~50Hz | 340mA  
Potência do sistema: 5,2W  
Material: alumínio/plástico

- Alcance de fixação: 0-6 mm
- Conversível em lâmpada de espelho desmontando o suporte



Down 300lm | 4000K

Versão	Art. n.º	EUR
● Cromado	1000777	115,00

### DORISA 50 WL

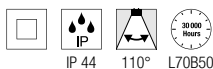
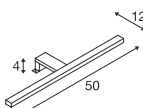

200-240V ~50Hz | 340mA  
Potência do sistema: 6,6W  
Material: alumínio/plástico

- Alcance de fixação: 0-6 mm
- Conversível em lâmpada de espelho desmontando o suporte



Down 370lm | 4000K

Versão	Art. n.º	EUR
● Cromado	1000780	127,00

### GLENOS® 60 WL

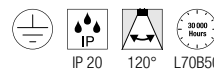
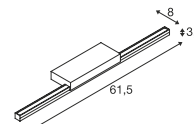

220-240V ~50/60Hz | 500mA  
Potência do sistema: 12W  
Material: alumínio/policarbonato (PC)

- Alcance de fixação: 0-6 mm
- Conversível em lâmpada de espelho desmontando o suporte



Down 1170lm | 3000K | 4000K

Versão	Art. n.º	EUR
● Preto	1003506	181,00
○ Branco	1003507	181,00
● Cinzento	1003508	181,00

Q-LINE®  
WL



1000669 368

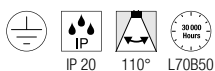
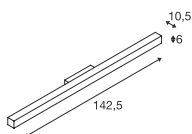

220-240V ~50/60Hz | 700mA  
Potência do sistema: 45W  
Material: alumínio/acrílico



Down 3800lm | 3000K

Versão	Art. n.º	EUR
● Preto	1000669	464,00
○ Branco	1000668	464,00
● Cinzento	1000670	464,00







### L-LINE 60 WL

### L-LINE 120 WL

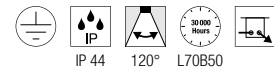
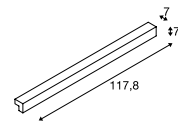
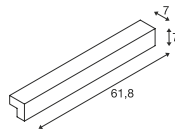

220-240V ~50/60Hz | 350mA  
Potência total: 10W  
Material: alumínio / policarbonato (PC)

220-240V ~50/60Hz | 350mA  
Potência total: 18,5W  
Material: alumínio / policarbonato (PC)



Down 820lm | 3000K

Down 1650lm | 3000K

Variante	Art. n.º	EUR
<input type="radio"/> Branco	<b>1001299</b>	<b>239,00</b>
<input type="radio"/> Prateado	<b>1001300</b>	<b>239,00</b>

Variante	Art. n.º	EUR
<input type="radio"/> Branco	<b>1001303</b>	<b>330,00</b>
<input type="radio"/> Prateado	<b>1001304</b>	<b>330,00</b>

# ÁREA PROTEGIDA NA CASA DE BANHO

As áreas protegidas correspondentes são definidas para uma iluminação segura na casa de banho. Para as áreas fora destas zonas de proteção, ou seja, sempre que seja improvável que a fonte de luz da casa de banho entre em contacto com a água, como o teto da casa de banho, não é prescrito qualquer índice de proteção.

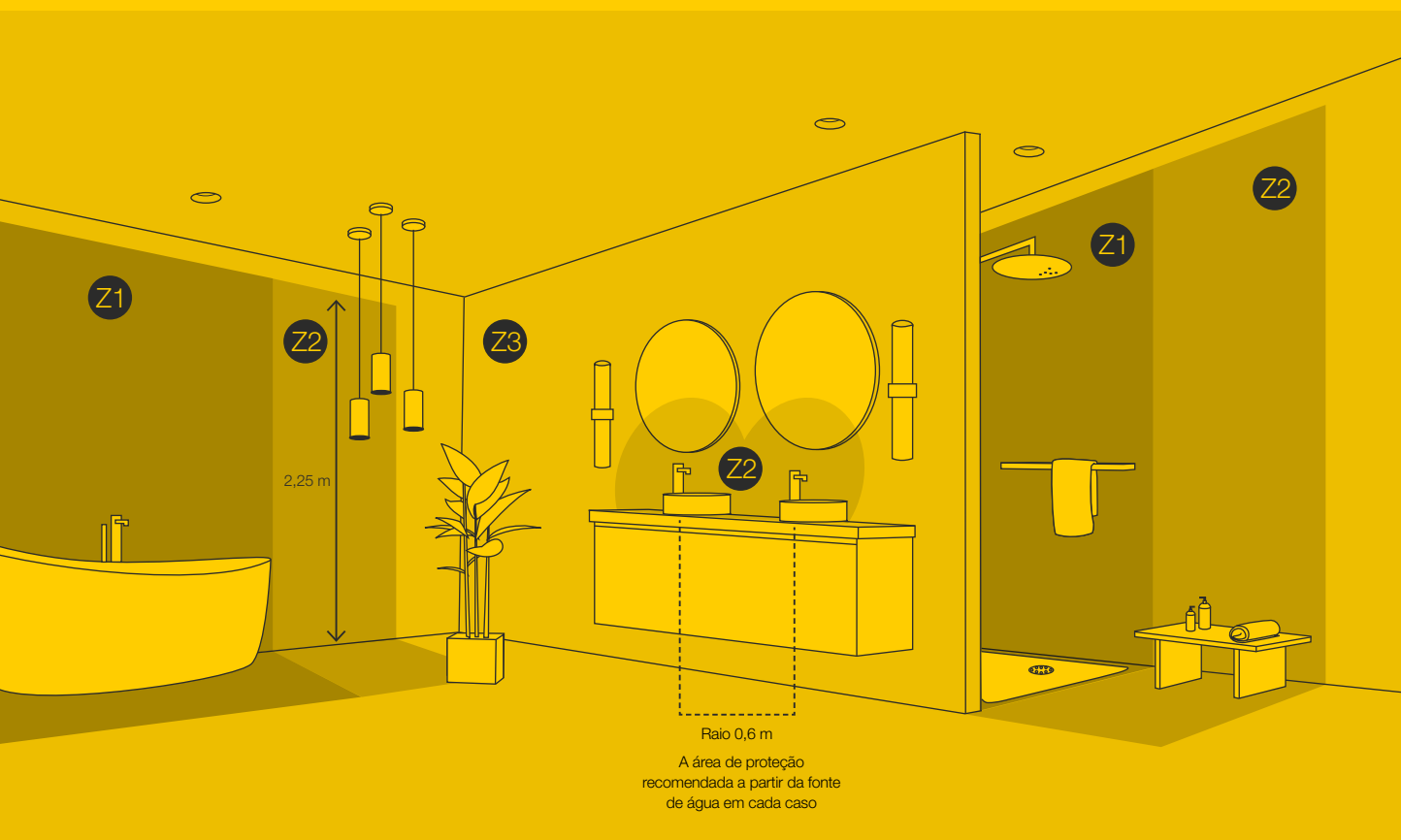

**Z1** ZONA 1

Mínimo IP65



**Z2** ZONA 2

Mínimo IP44



**Z3** ZONA 3

Mínimo IP21



Para tornar a iluminação em oásis modernos de bem-estar não só funcional e particularmente relaxante mas também segura, deve-se selecionar o índice de proteção IP correto em função da área de utilização.

A abreviatura IP significa Ingress Protection (Índice/classe de Proteção). O código IP padronizado, por exemplo, usa o primeiro dígito para indicar proteção contra corpos estranhos e contacto, enquanto o segundo descreve a impermeabilidade à água e à humidade. Este último é particularmente importante na casa de banho e no exterior.

## CORPOS ESTRANHOS    ÁGUA

Sem proteção	0	0	Sem proteção
Proteção contra corpos estranhos sólidos de maiores dimensões a partir de um diâmetro de 50 mm	1	1	Proteção contra queda vertical de pingos de água
Proteção contra corpos estranhos sólidos médios a partir de um diâmetro de 12,5 mm	2	2	Proteção contra queda de pingos de água quando o corpo da luminária está inclinado até 15°
Proteção contra corpos estranhos sólidos de menores dimensões a partir de um diâmetro de 2,5 mm	3	3	Proteção contra queda de água pulverizada em até 60° a partir da vertical
Proteção contra corpos estranhos sólidos muito pequenos a partir de um diâmetro de 1 mm	4	4	Proteção contra salpicos de água por todos os lados
Proteção contra poeiras em nociva abundância	5	5	Proteção contra jatos de água (bico) de qualquer ângulo
Totalmente à prova de pó	6	6	Proteção contra fortes jatos de água
		7	Proteção contra imersão temporária
		8	Proteção contra imersão permanente

### EXEMPLO IP 65:

O produto tem o nível 6, que é a máxima proteção contra o pó, e o nível 5 que é elevada proteção contra jatos de água. Pode estar classificado como sendo à prova de pó e à prova de água.





## PANTILHO ROPE WL, G9

1007595 373

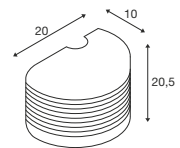

200-240V ~50/60Hz  
Material: vidro



Casquilho: 1xG9

Máx. Ø: 3 cm

C: 6 cm

Versão	Art. n.º	EUR
● Âmbar/dourado	<b>1007595</b>	<b>179,00</b>
● Antracite/prateado	<b>1007594</b>	<b>179,00</b>



LED G9 | 3,6W | 300°  
3000K | 400lm | CEE=E  
4kWh/1000h

Art. N.º: **1005286** | **8,80 EUR**







**ASTO TUBE**  
WL, single, GU10

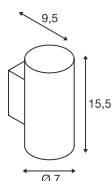

220-240V ~50/60Hz  
Material: alumínio

- Inclui refletor decorativo na cor do produto, feito de plástico reciclado
- Outros refletores decorativos coloridos disponíveis como opção



Casquilho: 1xGU10

Versão	Art. n.º	EUR
● Preto	1006441	60,00
○ Branco	1006442	60,00



LED GU10 51 mm | 6W | 38°  
2700K | 450lm | CEE=F  
6kWh/1000h



Art. N.º: 1005077 | 7,50 EUR

**ASTO TUBE**  
WL, up/down, GU10

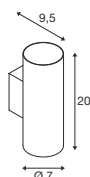

220-240V ~50/60Hz  
Material: alumínio

- Inclui refletor decorativo na cor do produto, feito de plástico reciclado
- Outros refletores decorativos coloridos disponíveis como opção



Casquilho: 2xGU10

Versão	Art. n.º	EUR
● Preto	1006443	80,00
○ Branco	1006444	80,00



LED GU10 51 mm | 6W | 36°  
2200-2700K | 360lm | CEE=G  
6kWh/1000h



Art. N.º: 1005273 | 9,99 EUR

**ASTO TUBE**  
Refletor decorativo



A: 3,95 cm  
Ø: 6,75 cm  
Material: policarbonato (PC)

Versão	Art. n.º	EUR
● Cromado preto	1007190	4,00
● Dourado	1006450	4,00
● Cromado	1006449	4,00
● Cobre	1006451	4,00

1006319 + 1004663 377 + 379

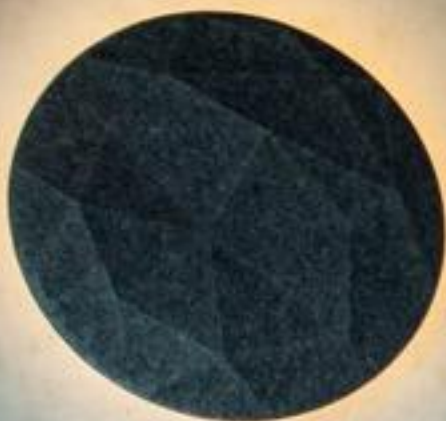

1004969 + 1004660 378







## MANA BASE WL, Redondo, PHASE

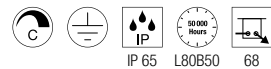
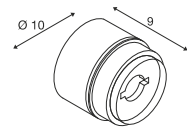

220-240V ~50/60Hz | 350mA  
Potência do sistema: 15W  
Material: alumínio/policarbonato (PC)

- Encontra os acessórios correspondentes nas páginas 378-379



Down 800lm | 2700K | 820lm | 3000K

Versão	Art. n.º	EUR
● Antracite	1006319	189,00



Artigo	Art. n.º	EUR
Abajur		
● Oxidado	1006317	59,00
● Oxidado	1006318	59,00



## MANA BASE Redondo

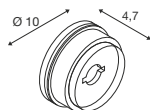

## MANA 40 Abajur, redondo, feltro acústico



A: 6 cm  
Ø: 40 cm  
Material: feltro/alumínio

Versão	Art. n.º	EUR
● Cinzento	1004661	99,00
● Bege	1004660	99,00



Material: alumínio/policarbonato (PC)

- Casquilho não iluminada para abajures redondos da série MANA

Versão	Art. n.º	EUR
● Antracite	1004969	26,00

## MANA 60 Abajur, redondo, feltro acústico



A: 6 cm  
Ø: 60 cm  
Material: feltro/alumínio

Versão	Art. n.º	EUR
● Cinzento	1004663	145,00
● Bege	1004662	145,00



**MANA 40**  
Abajur, redondo



NEW



A: 2,2 cm  
Ø: 40 cm  
Material: aço

**MANA 40**  
Abajur, redondo



NEW



A: 2,2 cm  
Ø: 40 cm  
Material: aço

**MANA 40**  
Abajur, redondo, estrutura lunar



NEW



A: 2,2 cm  
Ø: 40 cm  
Material: aço

Versão	Art. n.º	EUR
● Preto	1008201	79,00

Versão	Art. n.º	EUR
○ Branco	1008203	79,00

Versão	Art. n.º	EUR
● Dourado	1008205	99,00

**MANA 60**  
Abajur, redondo



NEW



A: 4,2 cm  
Ø: 60 cm  
Material: aço

**MANA 60**  
Abajur, redondo



NEW



A: 4,2 cm  
Ø: 60 cm  
Material: aço

**MANA 60**  
Abajur, redondo, estrutura lunar



NEW



A: 4,2 cm  
Ø: 60 cm  
Material: aço

Versão	Art. n.º	EUR
● Preto	1008202	125,00

Versão	Art. n.º	EUR
○ Branco	1008204	125,00

Versão	Art. n.º	EUR
● Dourado	1008206	145,00

1000613 + 1000616 381





MANA  
WL, Casquilho, PHASE

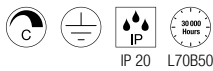
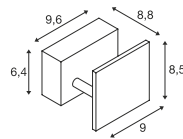

220-240V ~50/60Hz | 350mA  
Potência do sistema: 8,3W  
Material: alumínio/aço



Down 42lm | 2000K - 520lm | 3000K

Versão	Art. n.º	EUR
○ Branco	1000613	145,00

MANA  
Abajur



C: 12 cm A: 10 cm P: 9 cm  
Material: madeira

- Adequado para 1000613

Versão	Art. n.º	EUR
○ Branco	1000618	51,00
● Cinzento/Castanho	1000616	51,00

1000614 + 1000621 383





## MANA WL, Casquilho, PHASE

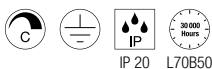
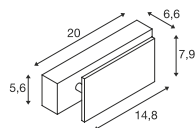

220-240V ~50/60Hz | 350mA  
Potência do sistema: 15W  
Material: alumínio/aço



Down 70lm | 2000K - 700lm | 3000K

Versão	Art. n.º	EUR
○ Branco	1000614	169,00

## MANA Abajur



C: 29 cm A: 9,5 cm P: 7 cm  
Material: madeira

- Adequado para 1000614

Versão	Art. n.º	EUR
○ Branco	1000623	61,00
● Cinzento/Castanho	1000621	61,00

1006307 385







### OCULUS WL, single, PHASE

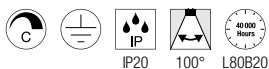
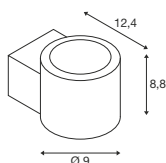

220-240V ~50/60Hz | 350mA  
Potência do sistema: 8 W



Down 57lm | 2000K - 570lm | 3000K

Versão	Art. n.º	EUR
● Preto	1006307	229,00
○ Branco	1006308	229,00

### OCULUS WL up/down, PHASE

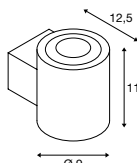

220-240V ~50/60Hz | 700mA  
Potência do sistema: 15W  
Material: alumínio/vidro

- Incluída lente fosca adicional



Up Down 22lm | 2000K - 555lm | 3000K

Versão	Art. n.º	EUR
● Preto	1004670	249,00
○ Branco	1004671	249,00

### OCULUS WL up/down, DTW

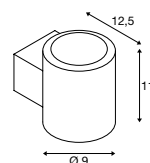

220-240V ~50/60Hz | 700mA  
Potência do sistema: 15W  
Material: alumínio



Down 22lm | 2000K - 550lm | 3000K

Versão	Art. n.º	EUR
● Latão (PVD)	1008613	369,00
● Cobre escuro (PVD)	1008614	369,00
● Bronze escuro (PVD)	1008612	369,00

PLASTRA  
WL, Cube, QT14

PLASTRA  
WL, cubes

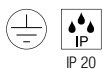
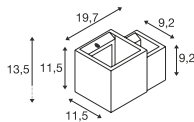
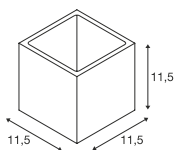
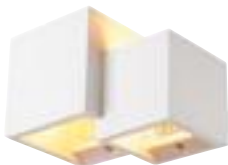

220-240V ~50/60Hz  
Material: gesso/aço

220-240V ~50/60Hz  
Material: gesso/aço

- Pode ser pintado/forrado individualmente à cor da parede

- Pode ser pintado/forrado individualmente à cor da parede



Casquilho: 1xG9

Casquilho: 2xG9 Máx. Ø: 7 cm C: 4 cm

Versão	Art. n.º	EUR
<input type="radio"/> Branco	148018	54,00

Versão	Art. n.º	EUR
<input type="radio"/> Branco	1004733	59,00



LED G9 | 3,6W | 300°  
3000K | 400lm | CEE=E  
4kWh/1000h



Art. N.º: 1005286 | 8,80 EUR



LED G9 | 3,6W | 300°  
3000K | 400lm | CEE=E  
4kWh/1000h



Art. N.º: 1005286 | 8,80 EUR

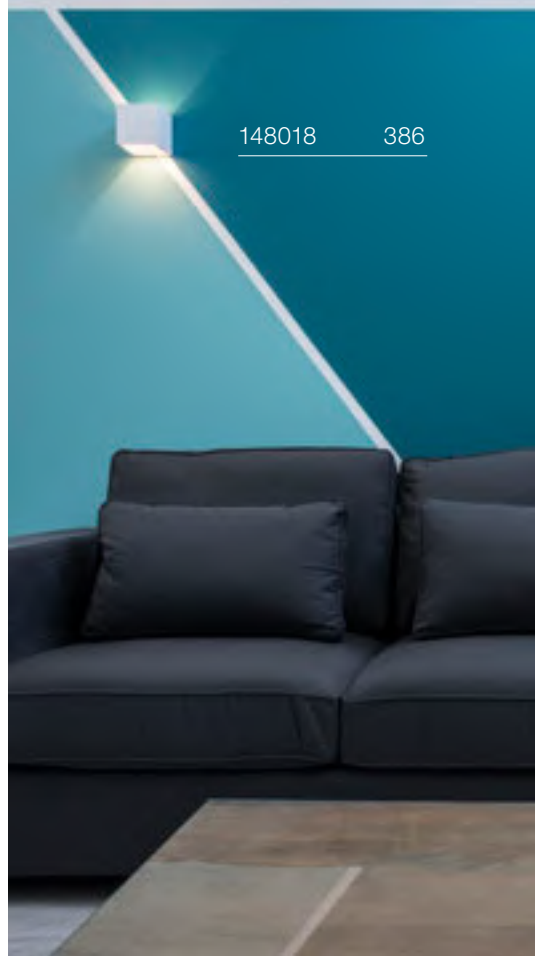



**PLASTRA**  
WL, Retangular, QT-DE12

**PLASTRA**  
WL, E14

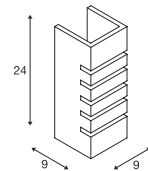
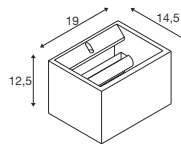

148010 387

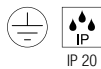

220-240V ~50/60Hz  
Material: gesso/aço

220-240V ~50/60Hz  
Material: gesso/aço

- Pode ser pintado/forrado individualmente à cor da parede

- Pode ser pintado/forrado individualmente à cor da parede



Casquilho: 1xR7s 118 mm

Casquilho: 1xE14

Versão	Art. n.º	EUR
○ Branco	1002238	79,00

Versão	Art. n.º	EUR
○ Branco	148010	52,00



LED R7s | 15W | 330°  
3000K | 2000lm | CEE=E  
15kWh/1000h



Art. N.º: 1005288 | 28,50 EUR



C35 | 4,2W | 320°  
2700K | 350lm | CEE=G  
5kWh/1000h



Art. N.º: 1005285 | 8,50 EUR

1004732 389



148091 389





**PLASTRA**  
WL, Semirredondo

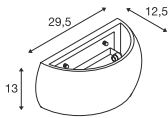

220-240V ~50/60Hz  
Material: gesso/aço

- Pode ser pintado/fornado individualmente à cor da parede



Casquilho: 1xR7s 118 mm Máx. Ø: 2 cm | C: 11,8 cm

Versão	Art. n.º	EUR
<input type="radio"/> Branco	<b>1004732</b>	<b>73,00</b>



LED R7s | 15W | 330°  
3000K | 2000lm | CEE=E  
15kWh/1000h



Art. N.º: **1005288** | **28,50 EUR**

**PLASTRA**  
WL, Proteção redonda

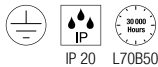
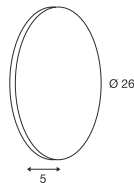

100-240V ~50/60Hz | 12V  
Potência do sistema: 6,5W  
Material: gesso/aço

- Pode ser pintado/fornado individualmente à cor da parede



Down 375lm | 3000K

Versão	Art. n.º	EUR
<input type="radio"/> Branco	<b>148091</b>	<b>189,00</b>

**PLASTRA**  
WL, Quadrado

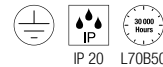
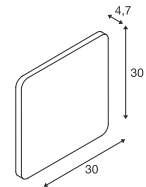

100-240V ~50/60Hz | 12V  
Potência do sistema: 10,5W  
Material: gesso/aço

- Pode ser pintado/fornado individualmente à cor da parede



Down 650lm | 3000K

Versão	Art. n.º	EUR
<input type="radio"/> Branco	<b>148019</b>	<b>216,00</b>



PLASTRA  
WL, QPAR51

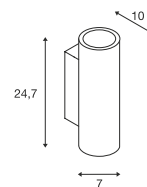

220-240V ~50/60Hz  
Material: gesso/aço

- Pode ser pintado/forrado individualmente à cor da parede

**SECRET INSIDE** <35 W

Casquilho: 2xGU10

Versão	Art. n.º	EUR
○ Branco	148060	67,00



LED GU10 51 mm | 6W | 36°  
2200-2700K | 360lm | CEE=G  
6kWh/1000h



Art. N.º: 1005273 | 9,99 EUR





**PLASTRA 101**  
WL, E14

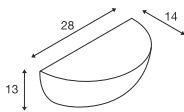

220-240V ~50/60Hz  
Material: gesso/aço

- Pode ser pintado/forrado individualmente à cor da parede



Casquilho: 1xE14 Máx. Ø: 4,5 cm | C: 11 cm

Versão	Art. n.º	EUR
<input type="radio"/> Branco	<b>148013</b>	<b>54,00</b>



C35 | 4,2W | 320°  
2700K | 350lm | CEE=G  
5kWh/1000h



Art. N.º: **1005285 | 8,50 EUR**

**PLASTRA**  
WL, Curve, QT-DE12

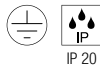
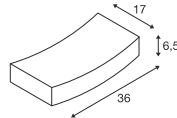

220-240V ~50/60Hz  
Material: gesso/aço

- Pode ser pintado/forrado individualmente à cor da parede



Casquilho: 1xR7s 78 mm

Versão	Art. n.º	EUR
<input type="radio"/> Branco	<b>148012</b>	<b>73,00</b>



LED R7s | 9W | 330°  
3000K | 1050lm | CEE=E  
9kWh/1000h



Art. N.º: **1005287 | 24,00 EUR**

**PLASTRA 104**  
WL, QT14

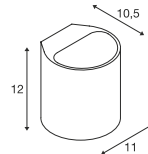

220-240V ~50/60Hz  
Material: gesso/aço

- Pode ser pintado/forrado individualmente à cor da parede



Casquilho: 1xG9

Versão	Art. n.º	EUR
<input type="radio"/> Branco	<b>148016</b>	<b>54,00</b>



LED G9 | 3,6W | 300°  
3000K | 400lm | CEE=E  
4kWh/1000h



Art. N.º: **1005286 | 8,80 EUR**

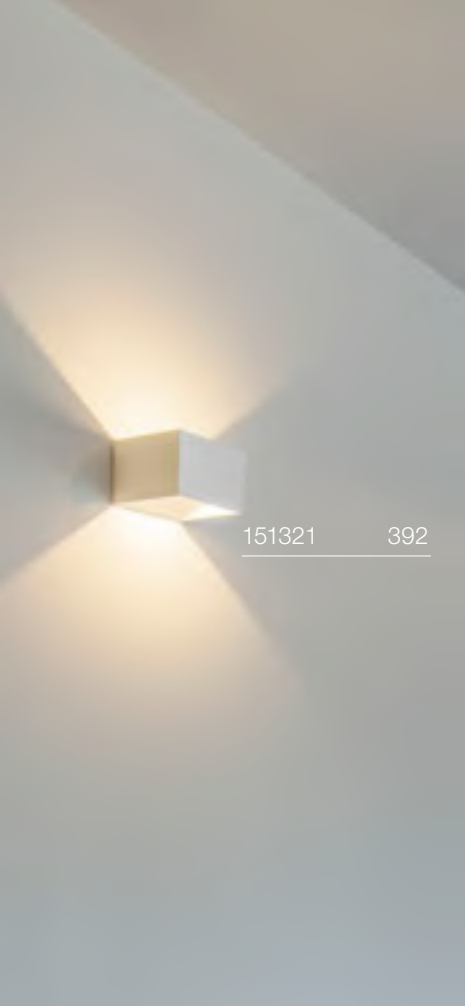

151321 392



1000638 392

## LOGS IN WL

## LOGS IN WL, PHASE

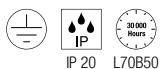
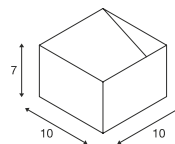
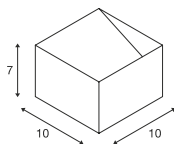

IP 20 L70B50

100-240V ~50/60Hz | 500mA  
Potência do sistema: 6W  
Material: alumínio

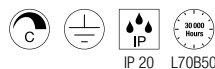

IP 20 L70B50

220-240V ~50/60Hz | 250mA  
Potência do sistema: 11W  
Material: alumínio



Up/Down 300lm | 3000K  
470lm

Versão	Art. n.º	EUR
● Preto/dourado 300lm	<b>151320</b>	<b>118,00</b>
○ Branco 470lm	<b>151321</b>	<b>118,00</b>



Up/Down 43lm | 2000K - 430lm | 3000K  
69lm

Versão	Art. n.º	EUR
● Preto/dourado 43-430lm	<b>1000638</b>	<b>159,00</b>
○ Branco 69-690lm	<b>1000639</b>	<b>159,00</b>
○ Alumínio/branco 69-690lm	<b>1000640</b>	<b>159,00</b>





1002843 393

LOGS IN L  
WL, PHASE

LOGS IN L  
WL, PHASE

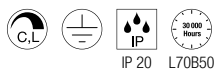
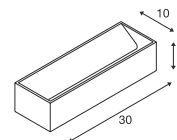
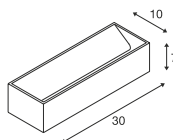

IP 20 L70B50

220-240V ~50/60Hz | 500mA  
Potência do sistema: 18W  
Material: alumínio



IP 20 L70B50

220-240V ~50/60Hz | 500mA  
Potência do sistema: 21W  
Material: alumínio



1002928 393



Up/Down 1100lm | 3000K  
1600lm

Versão	Art. n.º	EUR
● Preto/dourado 1100lm	<b>1002842</b>	<b>205,00</b>
○ Branco 1600lm	<b>1002844</b>	<b>205,00</b>
○ Aluminio/branco 1600lm	<b>1002843</b>	<b>205,00</b>



Up/Down 100lm | 2000K - 1000lm | 3000K  
140lm | 1390lm

Versão	Art. n.º	EUR
● Preto/dourado 100-1000lm	<b>1002928</b>	<b>275,00</b>
○ Branco 140-1390lm	<b>1002929</b>	<b>275,00</b>



1003467 395



1003468 395



### QUAD FRAME 14 WL

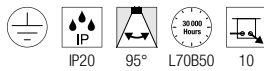
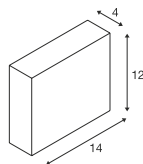
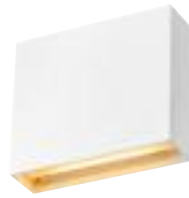

100-240V ~50/60Hz | 350mA  
Potência do sistema: 4,4W  
Material: alumínio



Down 165lm | 2700K | 175lm | 3000K

Versão	Art. n.º	EUR
<input type="radio"/> Branco	1003467	99,00

### QUAD FRAME 19 WL

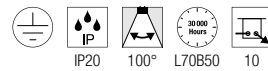
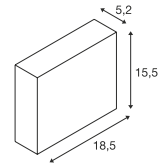

220-240V ~50/60Hz | 500mA  
Potência do sistema: 11W  
Material: alumínio



Down 580lm | 2700K | 640lm | 3000K

Versão	Art. n.º	EUR
<input type="radio"/> Branco	1003468	119,00



151275 396

ASSO 300  
WL, PHASE

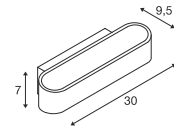

151410 397

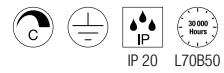

220-240V ~50/60Hz | 500mA  
Potência do sistema: 12W  
Material: alumínio/aço



Up/Down

975lm | 3000K

Versão	Art. n.º	EUR
○ Branco	151271	215,00
● Alumínio/branco	151275	226,00



### ASSO 300 WL, PHASE

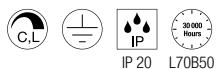
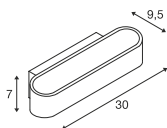
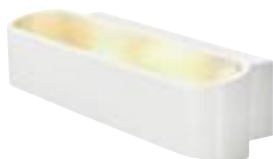

220-240V ~50/60Hz | 500mA  
Potência do sistema: 21W  
Material: alumínio/aço



Up/Down 135lm | 2000K - 1340lm | 3000K

Versão	Art. n.º	EUR
○ Branco	1000634	252,00

### OSSA 180 WL, QT-DE12

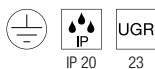
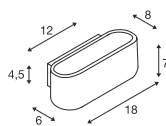

220-240V ~50/60Hz  
Material: alumínio/aço



Casquilho: 1xR7s 78 mm

Versão	Art. n.º	EUR
● Preto	151450	96,00
○ Branco	151451	96,00



LED R7s | 9W | 330°  
3000K | 1050lm | CEE=E  
9kWh/1000h



Art. N.º: 1005287 | 24,00 EUR

### OSSA 300 WL, QT-DE12

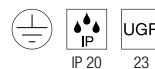
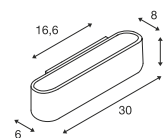

220-240V ~50/60Hz  
Material: alumínio/aço



Casquilho: 1xR7s 118 mm

Versão	Art. n.º	EUR
● Preto	151410	117,00
○ Branco	151411	117,00



LED R7s | 15W | 330°  
3000K | 2000lm | CEE=E  
15kWh/1000h



Art. N.º: 1005288 | 28,50 EUR

CARISO  
WL, PHASE

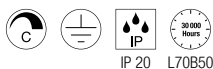
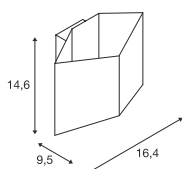
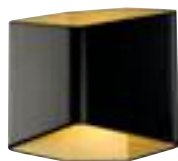

220-240V ~50/60Hz | 500mA  
Potência do sistema: 9,2W  
Material: alumínio/aço



Up/Down 250lm | 2700K  
560lm | 3000K

Versão	Art. n.º	EUR
● Preto/dourado 250lm   2700K	<b>151710</b>	<b>169,00</b>
○ Branco 560lm   3000K	<b>151711</b>	<b>165,00</b>

CARISO  
WL, PHASE

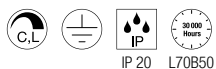
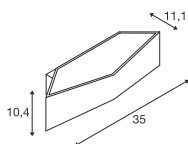

220-240V ~50/60Hz | 500mA  
Potência do sistema: 21W  
Material: alumínio/aço



Up/Down 100lm | 2000K - 1030lm | 3000K

Versão	Art. n.º	EUR
● Preto/dourado 58-580lm   1700-2700K	<b>151740</b>	<b>289,00</b>
○ Branco 100-1030lm   2000-3000K	<b>151741</b>	<b>279,00</b>



151710 398

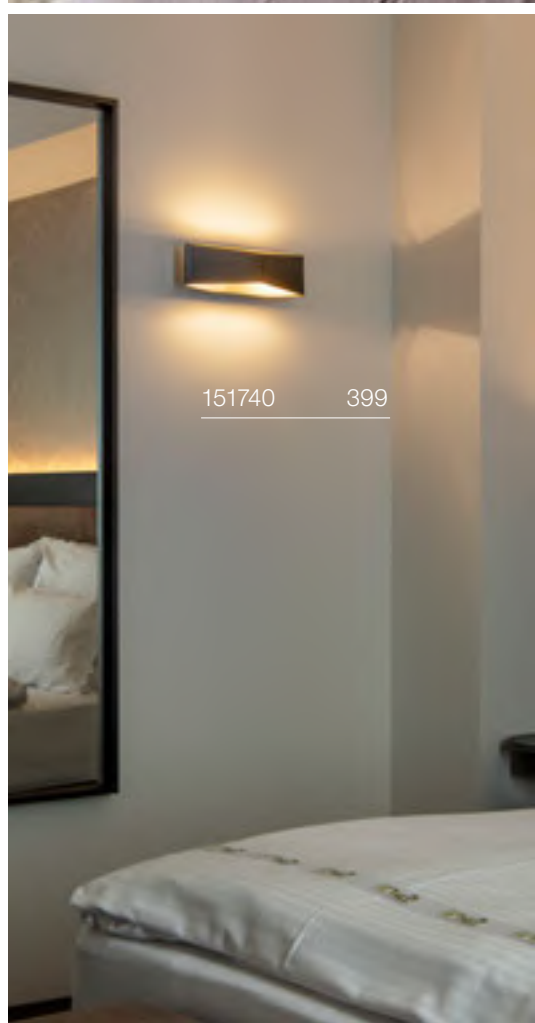

151740 399



## CHROMBO WL, PHASE

NEW

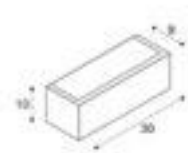

1003317 399

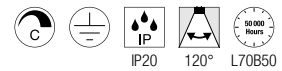

220-240V ~50/60Hz | 200mA  
Potência do sistema: 8W  
Material: aço/vidro



Down

790lm | 3000K

Versão	Art. n.º	EUR
● Preto	1008071	171,00
○ Branco	1003316	171,00

1004740 401



1004743 401







### DIRETO 60 WL, PHASE

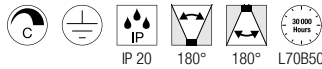
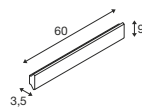
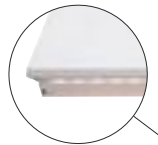

220-240V ~50/60Hz | 500mA  
Potência do sistema: 14W  
Material: alumínio



Up 590lm | 2700K | Down 625lm | 3000K

Versão	Art. n.º	EUR
● Preto	1004740	199,00
○ Branco	1004741	199,00

### DIRETO 90 WL, PHASE

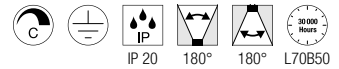
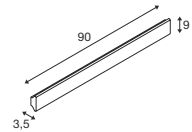
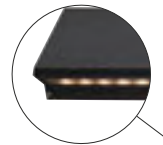

220-240V ~50/60Hz | 500mA  
Potência do sistema: 20W  
Material: alumínio



Up 840lm | 2700K | Down 880lm | 3000K

Versão	Art. n.º	EUR
● Preto	1004742	239,00
○ Branco	1004743	239,00

DENA 30  
WL, E14

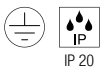
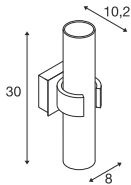

220-240V ~50/60Hz  
Material: alumínio

BASKET  
WL, E27

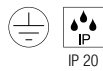
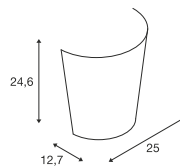

220-240V ~50/60Hz  
Material: vidro

151591 402



Casquilho: 2xE14 Máx. Ø: 5,1 cm C: 9,6 cm

Versão	Art. n.º	EUR
● Alumínio	147529	103,00



C35 | 4,2W | 320°  
2700K | 350lm | CEE=G  
5kWh/1000h



Art. N.º: 1005285 | 8,50 EUR



Casquilho: 1xE27 Máx. Ø: 5,2 cm C: 15,2 cm

Versão	Art. n.º	EUR
○ Branco	151591	97,00



LED E27 | 8W | 240°  
3000K | 880lm | CEE=E  
8kWh/1000h



Art. N.º: 1005289 | 10,25 EUR



1003429 403

### QUADRASS WL, E27

### QUADRASS SPOT WL, E27

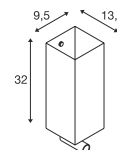
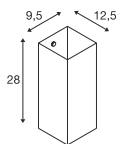

IP 20

220-240V ~50/60Hz  
Material: aço/vidro

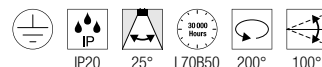

100-240V ~50/60Hz | 700mA  
Potência do sistema: 2W  
Material: aço/vidro

- Interruptor no corpo da luminária
- Fontes de luz comutáveis separadamente



Down 200lm | 3000K



Casquilho: 1xE27 Máx. Ø: 6,5 cm | C: 18 cm

Versão	Art. n.º	EUR
● Preto	1003430	140,00
○ Branco	1003431	140,00



LED E27 | 13,2W | 220°  
2700K | 1300lm | CEE=F  
13kWh/1000h



Art. N.º: 1005302 | 12,25 EUR



Casquilho: 1xE27 Máx. Ø: 6,5 cm | C: 18 cm

Versão	Art. n.º	EUR
● Preto	1003428	211,00
○ Branco	1003429	211,00



A60 | 7,5W | 320°  
2700K | 800lm | CEE=F  
8kWh/1000h



Art. N.º: 1005303 | 9,60 EUR

**FITU**  
Haste de suporte para  
parede

MIX  
match

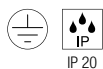
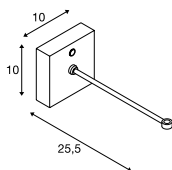

Material: aço

- Luminárias suspensas a combinar, consulte a página 299

Versão	Art. n.º	EUR
● Preto	1004682	64,00

**FITU CUBE**  
WL, E27

MIX  
match

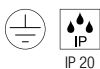
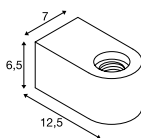

220-240V ~50/60Hz  
Material: aço



Casquilho: 1xE27 Máx. Ø: 12,5 cm

Versão	Art. n.º	EUR
● Preto	1004738	80,00
○ Branco	1004739	80,00



A60 | 7,5W | 180°  
2700K | 720lm | CEE=F  
8kWh/1000h



Art. N.º: 1005305 | 19,00 EUR

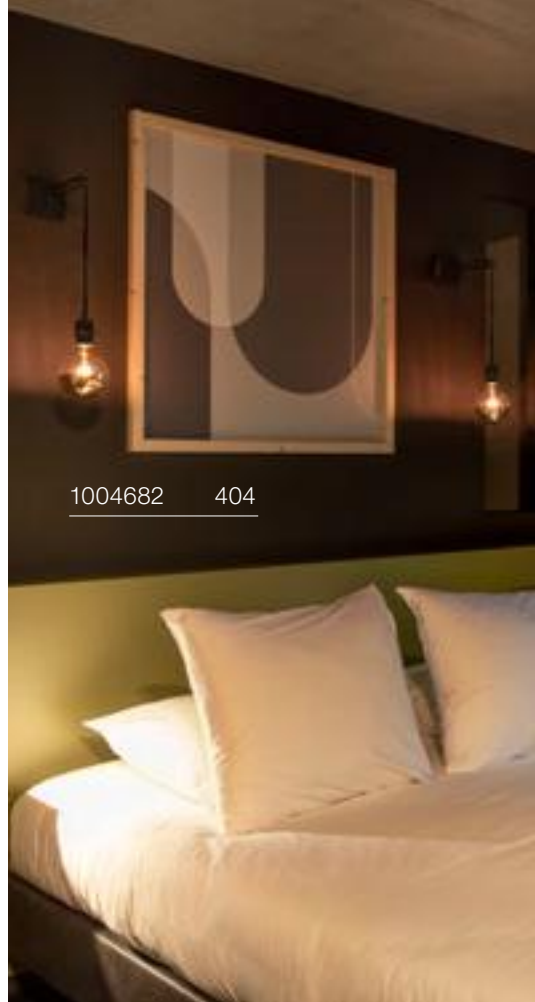

1004682 404

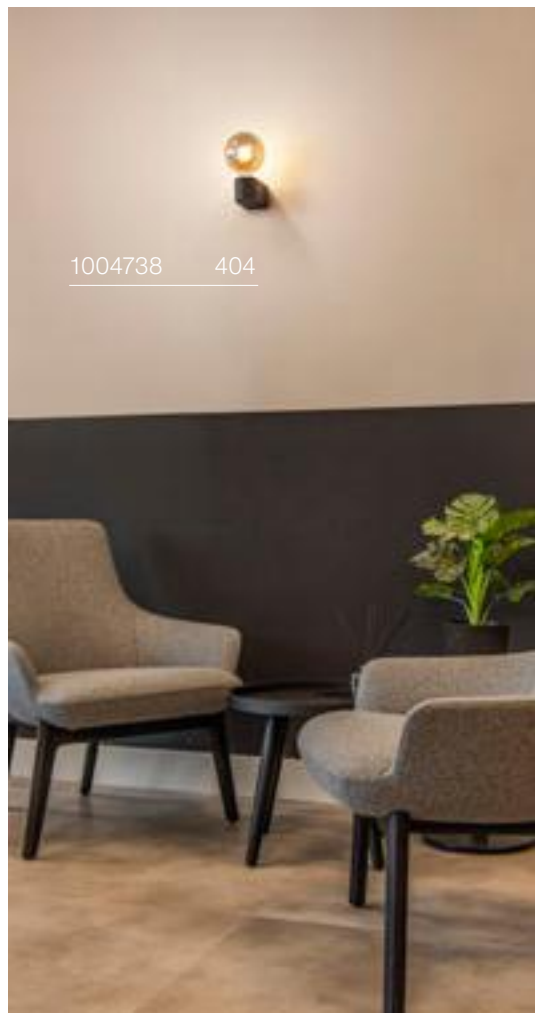

1004738 404



THEO UP/DOWN  
WL, QPAR51

SOLID CUBE  
WL, QT14

1000327 405

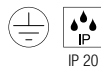
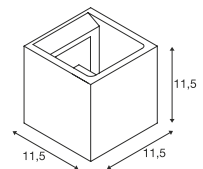
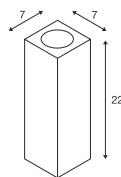

IP 20

220-240V ~50/60Hz  
Material: alumínio



IP 20

220-240V ~50/60Hz  
Material: betão

1000910 405



Casquilho: 2xGU10

Versão	Art. n.º	EUR
● Antracite	1000330	109,00
○ Branco	1000327	109,00
● Alumínio	1000329	119,00



Casquilho: 1xG9

Versão	Art. n.º	EUR
● Cinzento	1000910	97,00
● Preto	1000911	97,00



LED GU10 51 mm | 6W | 38°  
2700K | 450lm | CEE=F  
6kWh/1000h



Art. N.º: 1005077 | 7,50 EUR



LED G9 | 3,6W | 300°  
3000K | 400lm | CEE=E  
4kWh/1000h



Art. N.º: 1005286 | 8,80 EUR

151803 406





ENOLA B  
WL, QPAR51

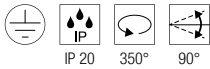
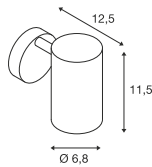

220-240V ~50/60Hz  
Material: alumínio/aço

- Interruptor no corpo da luminária



Casquilho: 1xGU10 Máx. C: 6 cm

Versão	Art. n.º	EUR
● Preto	1000729	81,00
○ Branco	1000730	81,00



LED GU10 51 mm | 6W | 38°  
2700K | 450lm | CEE=F  
6kWh/1000h



Art. N.º: 1005077 | 7,50 EUR



Artigo	Art. n.º	EUR
Anel decorativo		
● Preto	151840	8,95

ENOLA B  
WL, QPAR51

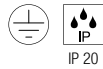
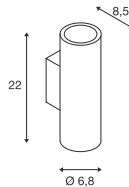

220-240V ~50/60Hz  
Material: alumínio/aço



Casquilho: 2xGU10 Máx. C: 8,5 cm

Versão	Art. n.º	EUR
● Preto	151800	94,00
○ Branco	151801	94,00
● Dourado	151803	104,00



LED GU10 51 mm | 6W | 38°  
3000K | 470lm | CEE=F  
6kWh/1000h



Art. N.º: 1005080 | 7,50 EUR



Artigo	Art. n.º	EUR
Anel decorativo		
● Preto	151840	8,95

ASTINA UP/DOWN  
WL, QPAR51

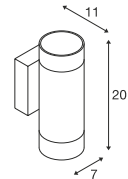

220-240V ~50/60Hz  
Material: alumínio/aço



Casquilho: 2xGU10

Versão	Art. n.º	EUR
● Preto	1002933	112,00
○ Branco	1002931	112,00



LED GU10 51 mm | 6W | 36°  
2200-2700K | 360lm | CEE=G  
6kWh/1000h



Art. N.º: 1005273 | 9,99 EUR

FENDA  
WL, Casquilho, E27

MIX  
match

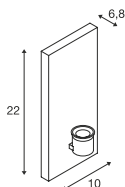

220-240V ~50/60Hz  
Material: aço/plástico



Casquilho: 1xE27 Máx. Ø: 5,1 cm C: 20 cm

Versão	Art. n.º	EUR
○ Branco	1001272	52,00



LED E27 | 8W | 240°  
3000K | 880lm | CEE=E  
8kWh/1000h



Art. N.º: 1005289 | 10,25 EUR

FENDA  
Abajur

MIX  
match



L: 23 cm A: 30 cm P: 12 cm  
Material: têxtil/aço

Versão	Art. n.º	EUR
● Preto	1001273	38,50
● Preto/cobre	1001274	44,75
○ Branco	1001275	38,50
● Bege	1001276	38,50

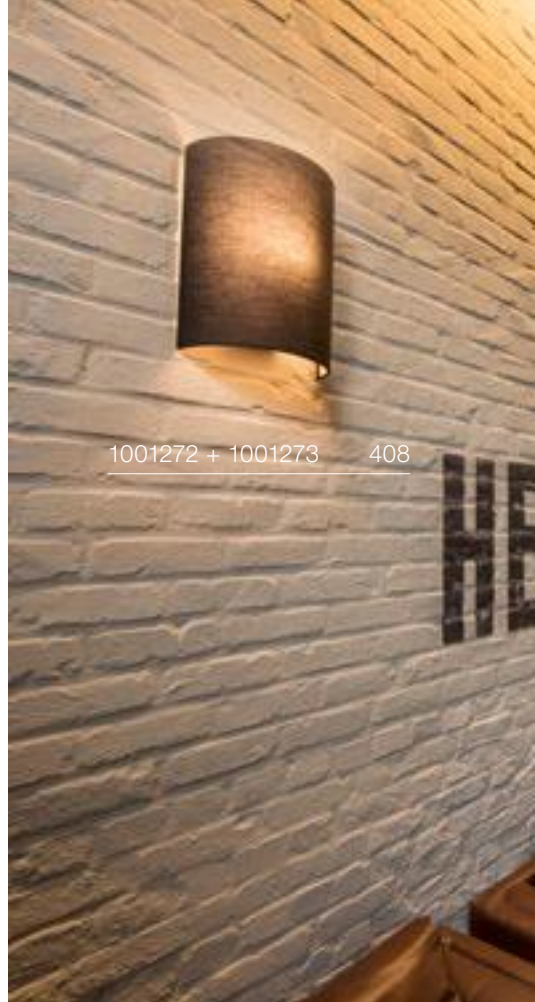

1001272 + 1001273 408



149452 409





### KENKUA SPOT WL, E27

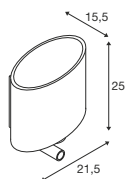

100-240V ~50/60Hz | 700mA  
Potência do sistema: 2W  
Material: aço/vidro

- Fontes de luz na luminária comutáveis separadamente.



Down 200lm | 3000K



Casquilho: 1xE27 Máx. Ø: 6,5 cm | C: 12 cm

Versão	Art. n.º	EUR
● Cromado	1002855	206,00



A60 | 7,5W | 320°  
2700K | 800lm | CEE=F  
8kWh/1000h



Art. N.º: 1005303 | 9,60 EUR

### COUPA FLEX WL

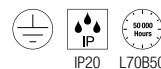
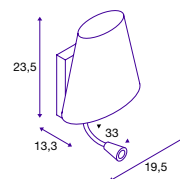

220-240V ~50/60Hz | 700mA  
Potência do sistema: 3,4W  
Material: aço/vidro

- Fontes de luz na luminária comutáveis separadamente.



Down 240lm | 3000K



Casquilho: 1xG9 Máx. C: 9 cm

Versão	Art. n.º	EUR
● Cromado	149452	206,00



LED G9 | 3,6W | 300°  
3000K | 400lm | CEE=E  
4kWh/1000h



Art. N.º: 1005286 | 8,80 EUR



KARPO MAGN  
CW, single, PHASE

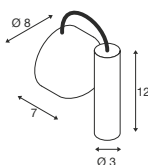

220-240V ~50/60Hz | 500mA  
Potência do sistema: 6,2W  
Material: aço/alumínio

- Cabeça da luminária livremente posicionável devido ao suporte magnético



Down 350lm | 3000K

Versão	Art. n.º	EUR
● Preto	1004706	197,00

KARPO GOOSE  
WL

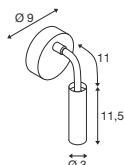

220-240V ~50/60Hz | 12V  
Potência do sistema: 5,8W  
Material: alumínio/aço

- A luz é regulável através do interruptor na cabeça da luminária



Down 380lm | 420lm | 3000K

Versão	Art. n.º	EUR
● Preto	1006162	179,00
○ Branco	1006161	179,00

1006161 410



1002140 411

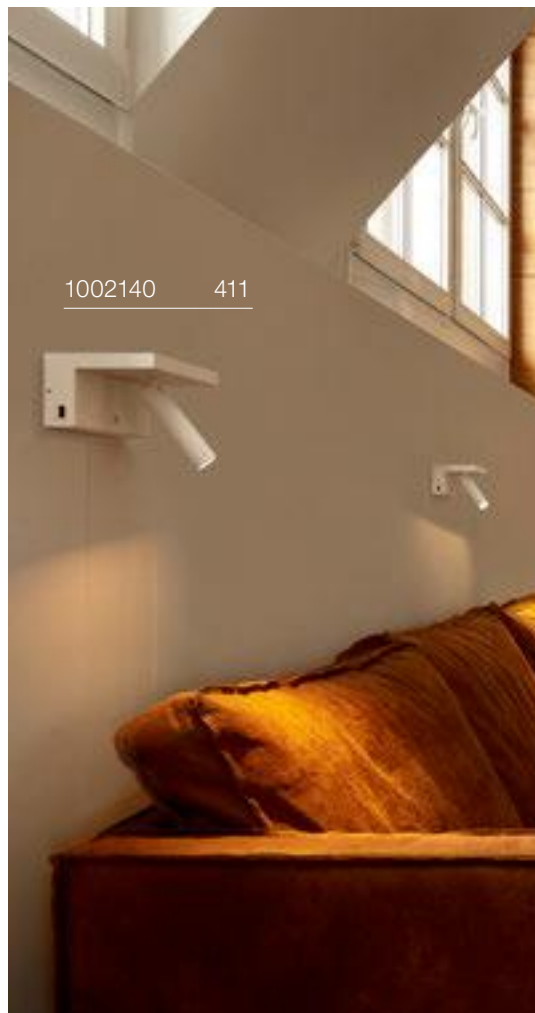



## KARPO 30 WL, single

## KARPO WL

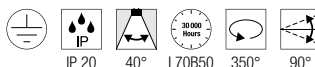
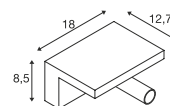
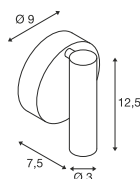

100-240V ~50/60Hz | 500mA  
Potência do sistema: 6W  
Material: alumínio/aço

220-240V ~50/60Hz | 500mA  
Potência do sistema: 6,8W  
Material: alumínio

- Interruptor no corpo da luminária

- 2 ligações USB 1,5 Amp. máx.
- 3 níveis reguláveis através de interruptor na Casquilho



Down 370lm | 3000K  
400lm

Down 390lm | 3000K

Versão	Art. n.º	EUR
● Preto		
370lm	<b>152340</b>	<b>125,00</b>
○ Branco		
400lm	<b>152341</b>	<b>125,00</b>

Versão	Art. n.º	EUR
○ Branco	<b>1002140</b>	<b>242,00</b>



1003457 412

## SOMNILA SPOT WL, Esquerda

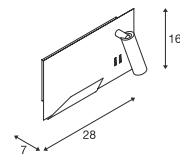

1003459 413

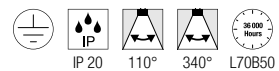

100-240V ~50/60Hz | 12V  
Potência do sistema: 15W  
Material: alumínio/aço

- 1 ligação USB
- Fontes de luz na estrutura comutáveis separadamente



IRC  
90

Down

120lm | 3000K

Versão	Art. n.º	EUR
● Preto 490lm	1003455	232,00
○ Branco 770lm	1003457	232,00



### SOMNILA SPOT WL, Direita

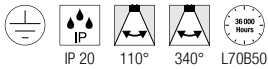
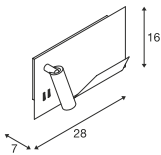

100-240V ~50/60Hz | 12V  
Potência do sistema: 15W  
Material: alumínio/aço

- 1 ligação USB
- Fontes de luz na estrutura comutáveis separadamente



Down 120lm | 3000K

Versão	Art. n.º	EUR
● Preto 490lm	1003456	232,00
○ Branco 770lm	1003458	232,00

### SOMNILA FLEX WL, Esquerda

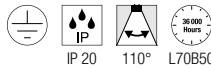
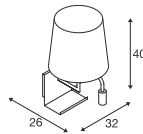

100-240V ~50/60Hz | 12V  
Material: alumínio

- Fontes de luz na estrutura comutáveis separadamente.



Down 120lm | 3000K

Versão	Art. n.º	EUR
○ Branco	1003459	242,00

### SOMNILA FLEX WL, Direita

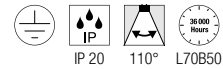
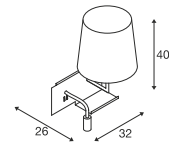

100-240V ~50/60Hz | 12V  
Material: alumínio

- Fontes de luz na estrutura comutáveis separadamente.



Down 120lm | 3000K

Versão	Art. n.º	EUR
○ Branco	1003460	242,00

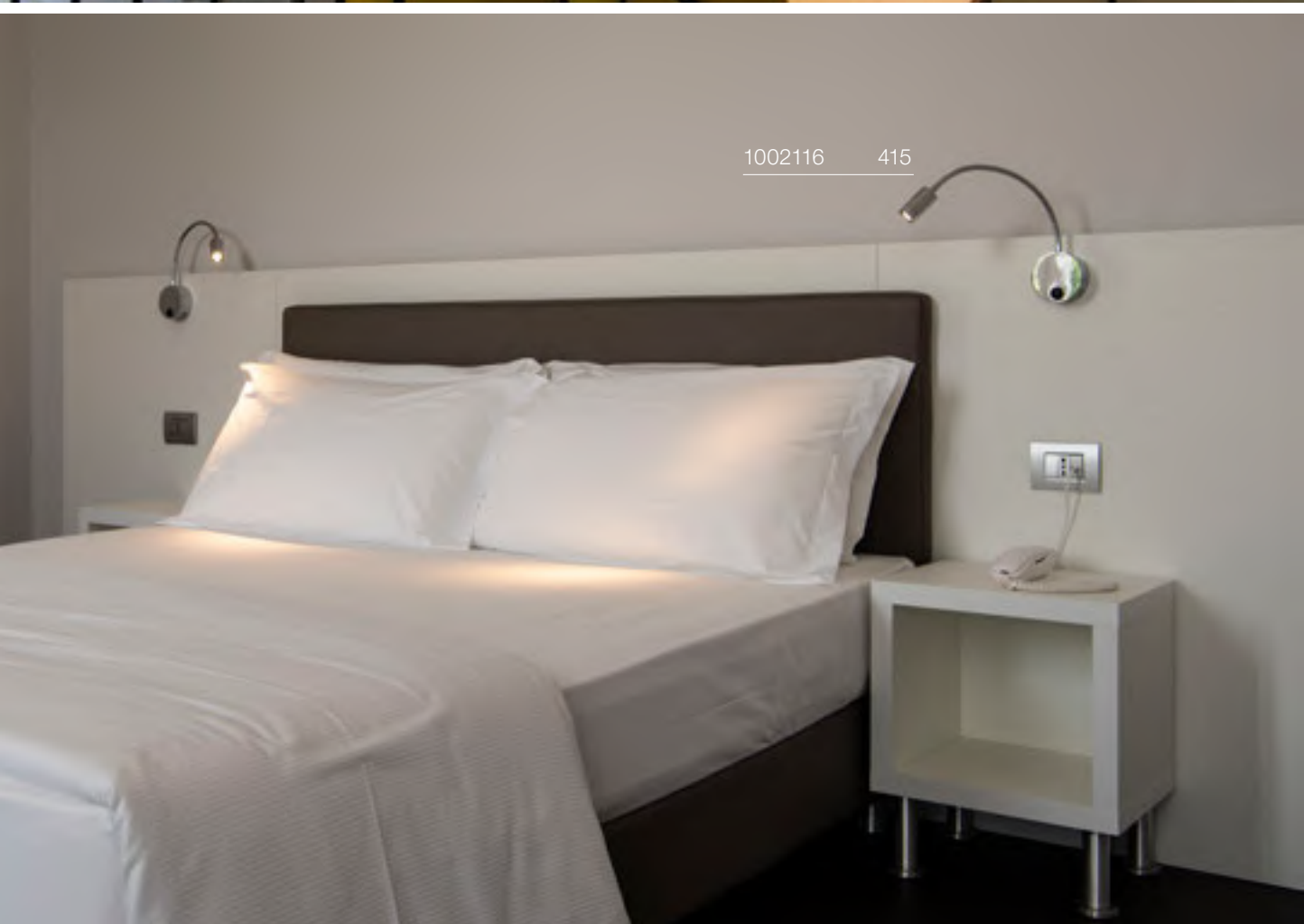



## DIO FLEX PLATE WL QPAR51

## DIO FLEX PLATE WL

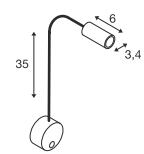
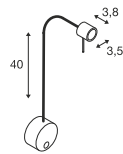

IP 20

220-240V ~50/60Hz  
Material: alumínio

- Interruptor no corpo da luminária

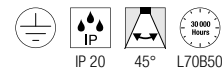

IP 20 45° L70B50

100-240V ~50/60Hz | 350mA  
Potência do sistema: 1,9W  
Material: alumínio/vidro

- Interruptor no corpo da luminária



Casquilho: 1xGU10

Versão	Art. n.º	EUR
● Preto	1002608	57,00
○ Branco	1002607	57,00
● Cromado	146692	66,00



Down 100lm | 2700K | 3000K

Versão	Art. n.º	EUR
● Preto 2700K	1002430	100,00
● Preto 3000K	1002431	100,00
○ Branco 2700K	1002117	100,00
○ Branco 3000K	1002118	100,00
● Cromado 3000K	146682	106,00



LED GU10 51 mm | 6W | 38°  
3000K | 470lm | CEE=F  
6kWh/1000h



Art. N.º: 1005080 | 7,50 EUR

**PHELIA**  
WL, QPAR51

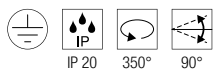
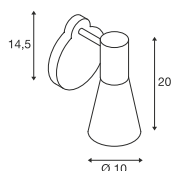

220-240V ~50/60Hz  
Material: alumínio/aço

- Interruptor na cabeça da luminária



Casquilho: 1xGU10 Máx. Ø: 5,1 cm | C: 10,5 cm

Versão	Art. n.º	EUR
● Preto	148540	131,00



LED GU10 51 mm | 6W | 38°  
2700K | 450lm | CEE=F  
6kWh/1000h



Art. N.º: 1005077 | 7,50 EUR

**MERADO FLOOD**  
WL, PHASE

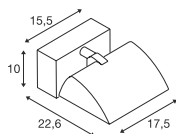

220-240V ~50/60Hz | 1000mA  
Potência do sistema: 40W  
Material: alumínio



Down 3000lm | 3000K  
3200lm | 4000K

Versão	Art. n.º	EUR
○ Branco 3000lm   3000K	1001468	247,00
○ Branco 3200lm   4000K	1001472	247,00



148540 416



1001468 416





DISPLAY ADL 50  
QPAR51

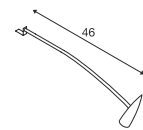

1002860 417



220-240V ~50/60Hz  
Material: alumínio/latão

- Extremidade do cabo aberta da caixa de ligação incl.  
• Extremidade do cabo aberta



Casquilho: 1xGU10

Versão	Art. n.º	EUR
○ Branco	1002860	48,25
● Cromado	146332	62,00



LED GU10 51 mm | 6W | 36°  
2200-2700K | 360lm | CEE=G  
6kWh/1000h



Art. N.º: 1005273 | 9,99 EUR



1008579 418

## DECONA 30 CW, PHASE

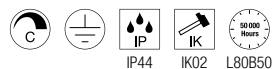
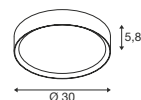

220-240V ~50/60Hz  
Potência do sistema: 18W  
Material: alumínio/PC



Down 1600lm | 2700K | 1600lm | 3000K

Versão	Art. n.º	EUR
● Preto 1450/1450lm	1008578	119,00
● Preto/dourado 1560/1560lm	1008580	119,00
○ Branco 1600/1600lm	1008577	119,00
○ Branco/dourado 1530/1530lm	1008579	119,00



### DECONA 42 CW, PHASE



### DECONA Caixa de montagem para encastrar 310 mm



A: 7,5 cm  
Ø: 31,3 cm  
Material: alumínio

### DECONA Caixa de montagem para encastrar 430 mm



A: 7,5 cm  
Ø: 43,3 cm  
Material: alumínio

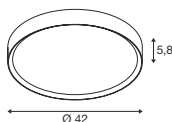

Versão	Art. n.º	EUR
<input type="radio"/> Branco	1008585	59,00

Versão	Art. n.º	EUR
<input type="radio"/> Branco	1008586	69,00

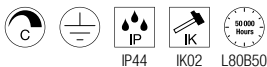

220-240V ~50/60Hz | 300  
Potência do sistema: 23W  
Material: alumínio/PC



Down 2020lm | 2700K | 2020lm | 3000K

Versão	Art. n.º	EUR
● Preto 2260/2260lm	1008582	149,00
● Preto/dourado 2170/2170lm	1008584	149,00
○ Branco 2140/2140lm	1008581	149,00
○ Branco/dourado 2020/2020lm	1008583	149,00

### DECONA kit de suspensão 1,50 m



C: 150 cm  
Material: aço

Versão	Art. n.º	EUR
● Preto	1008587	28,00
○ Branco	1008588	28,00

1008334 421



## PURI 2.0 Tube



220-240V ~50/60Hz  
Material: alumínio

**SOCKET**  
**INSIDE** 6 W

Casquilho: 1-4xGU10 Máx. Ø: 5,1 cm | C: 5,5 cm



LED GU10 51 mm | 6W | 38°  
2700K | 450lm | CEE=F  
6kWh/1000h



Art. N.º: 1005075 | 7,50 EUR

1008308 420



## PURI 2.0 Tube CW, Double Asym., QPAR51

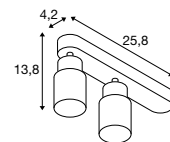

Versão	Art. n.º	EUR
● Preto	1008308	94,00
● Preto/dourado	1008309	94,00
○ Branco	1008310	94,00
● Cinzento	1008311	94,00



PURI 2.0  
Tube CW, Single, QPAR51

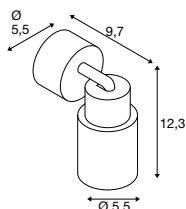

Versão	Art. n.º	EUR
● Preto	1008284	45,90
● Preto/dourado	1008285	45,90
○ Branco	1008286	45,90
● Cinzento	1008287	45,90

PURI 2.0  
Tube CW, Interruptor, Single, QPAR51

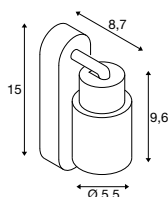

Versão	Art. n.º	EUR
● Preto	1008296	54,90
● Preto/dourado	1008297	54,90
○ Branco	1008298	54,90
● Cinzento	1008299	54,90

PURI 2.0  
Tube CW, Double Long, QPAR51

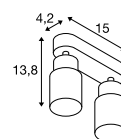

Versão	Art. n.º	EUR
● Preto	1008361	79,00
● Preto/dourado	1008362	79,00
○ Branco	1008363	79,00
● Cinzento	1008364	79,00

PURI 2.0  
Tube CW, Triple Long, QPAR51

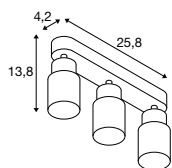

Versão	Art. n.º	EUR
● Preto	1008320	119,00
● Preto/dourado	1008321	119,00
○ Branco	1008322	119,00
● Cinzento	1008323	119,00

PURI 2.0  
Tube CW, Triple Round, QPAR51

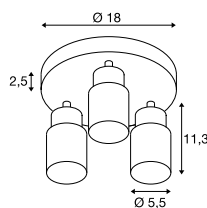

Versão	Art. n.º	EUR
● Preto	1008332	139,00
● Preto/dourado	1008333	139,00
○ Branco	1008334	139,00
● Cinzento	1008335	139,00

PURI 2.0  
Tube CW, Quadruple Long, QPAR51

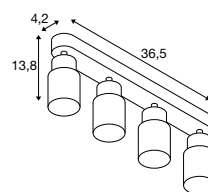

Versão	Art. n.º	EUR
● Preto	1008344	169,00
● Preto/dourado	1008345	169,00
○ Branco	1008346	169,00
● Cinzento	1008347	169,00



1008313 422

## PURI 2.0 Cone

NEW



220-240V ~50/60Hz  
Material: alumínio

**SOCKET  
INSIDE** 6  
W

Casquilho: 1-4xGU10 Máx. Ø: 5,1 cm | C: 5,5 cm



LED GU10 51 mm | 6W | 38°  
3000K | 470lm | CEE=F  
6kWh/1000h



Art. N.º: 1005080 | 7,50 EUR



1008367 423

## PURI 2.0 Cone CW, Double Asym., QPAR51

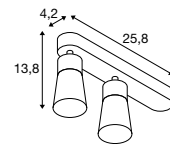

Versão	Art. n.º	EUR
● Preto	1008312	94,00
● Preto/dourado	1008313	94,00
○ Branco	1008314	94,00
● Cinzento	1008315	94,00



PURI 2.0  
Cone CW, Single, QPAR51

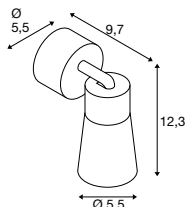

Versão	Art. n.º	EUR
● Preto	1008288	45,90
● Preto/dourado	1008289	45,90
○ Branco	1008290	45,90
● Cinzento	1008291	45,90

PURI 2.0  
Cone CW, Interruptor, Single, QPAR51

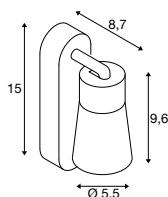

Versão	Art. n.º	EUR
● Preto	1008300	54,90
● Preto/dourado	1008301	54,90
○ Branco	1008302	54,90
● Cinzento	1008303	54,90

PURI 2.0  
Cone CW, Double Long, QPAR51

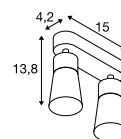

Versão	Art. n.º	EUR
● Preto	1008365	79,00
● Preto/dourado	1008366	79,00
○ Branco	1008367	79,00
● Cinzento	1008368	79,00

PURI 2.0  
Cone CW, Triple Long, QPAR51

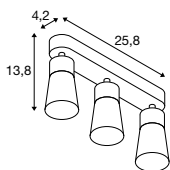

Versão	Art. n.º	EUR
● Preto	1008324	119,00
● Preto/dourado	1008325	119,00
○ Branco	1008326	119,00
● Cinzento	1008327	119,00

PURI 2.0  
Cone CW, Triple Round, QPAR51

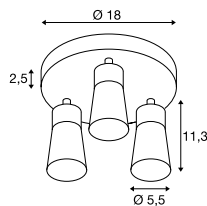

Versão	Art. n.º	EUR
● Preto	1008336	139,00
● Preto/dourado	1008337	139,00
○ Branco	1008338	139,00
● Cinzento	1008339	139,00

PURI 2.0  
Cone CW, Quadruple Long, QPAR51

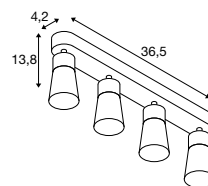

Versão	Art. n.º	EUR
● Preto	1008348	169,00
● Preto/dourado	1008349	169,00
○ Branco	1008350	169,00
● Cinzento	1008351	169,00

1008292 425



## PURI 2.0 Dome



220-240V ~50/60Hz  
Material: alumínio

**SOCKET**  
**INSIDE** 6  
W

Casquilho: 1-4xGU10 Máx. Ø: 5,1 cm | C: 5,5 cm



LED GU10 51 mm | 6W | 38°  
3000K | 470lm | CEE=F  
6kWh/1000h



Art. N.º: 1005079 | 7,50 EUR

1008352 425



## PURI 2.0 Dome CW, Double Asym., QPAR51

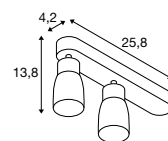

Versão	Art. n.º	EUR
● Preto	1008316	94,00
● Preto/dourado	1008317	94,00
○ Branco	1008318	94,00
● Cinzento	1008319	94,00





PURI 2.0  
Dome CW, Single, QPAR51

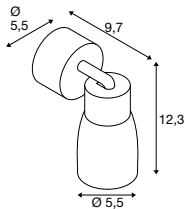

Versão	Art. n.º	EUR
● Preto	1008292	45,90
● Preto/dourado	1008293	45,90
○ Branco	1008294	45,90
● Cinzento	1008295	45,90

PURI 2.0  
Dome CW, Interruptor, Single, QPAR51

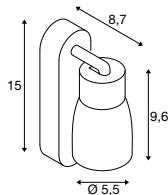

Versão	Art. n.º	EUR
● Preto	1008304	54,90
● Preto/dourado	1008305	54,90
○ Branco	1008306	54,90
● Cinzento	1008307	54,90

PURI 2.0  
Dome CW, Double Long, QPAR51

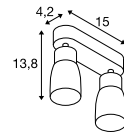

Versão	Art. n.º	EUR
● Preto	1008369	79,00
● Preto/dourado	1008370	79,00
○ Branco	1008371	79,00
● Cinzento	1008372	79,00

PURI 2.0  
Dome CW, Triple Long, QPAR51

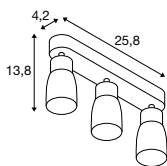

Versão	Art. n.º	EUR
● Preto	1008328	119,00
● Preto/dourado	1008329	119,00
○ Branco	1008330	119,00
● Cinzento	1008331	119,00

PURI 2.0  
Dome CW, Triple Round, QPAR51

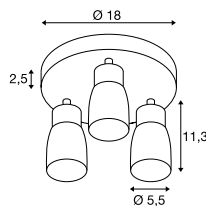

Versão	Art. n.º	EUR
● Preto	1008340	139,00
● Preto/dourado	1008341	139,00
○ Branco	1008342	139,00
● Cinzento	1008343	139,00

PURI 2.0  
Dome CW, Quadruple Long, QPAR51

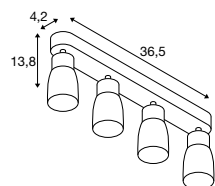

Versão	Art. n.º	EUR
● Preto	1008352	169,00
● Preto/dourado	1008353	169,00
○ Branco	1008354	169,00
● Cinzento	1008355	169,00



1008233 426

NEW

## PURI 2.0 Basic

MIX  
match



220-240V ~50/60Hz  
Material: alumínio

- Pode encontrar abajures a condizer na página 429

SOCKET  
INSIDE 6  
W

Casquilho: 1-4xGU10 Máx. Ø: 5,1 cm | C: 5,5 cm



LED GU10 51 mm | 6W | 36°  
2200-2700K | 360lm | CEE=G C.L.

Art. N.º: 1005273 | 9,99 EUR

## PURI 2.0 Basic CW, Double Asym., QPAR51

MIX  
match

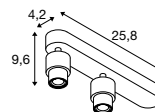

Versão	Art. n.º	EUR
● Preto	1008233	79,00
○ Branco	1008232	79,00



PURI 2.0  
Basic CW, Single, QPAR51

MIX  
match

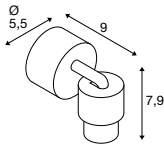

Versão	Art. n.º	EUR
● Preto	1008229	39,00
○ Branco	1008228	39,00

PURI 2.0  
Basic CW, Interruptor, Single, QPAR51

MIX  
match

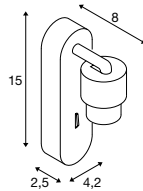

Versão	Art. n.º	EUR
● Preto	1008231	49,00
○ Branco	1008230	49,00

PURI 2.0  
Basic CW, Double Long, QPAR51

MIX  
match

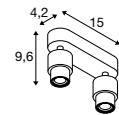

Versão	Art. n.º	EUR
● Preto	1008241	79,00
○ Branco	1008240	79,00

PURI 2.0  
Basic CW, Triple Long, QPAR51

MIX  
match

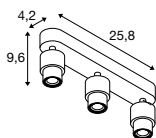

Versão	Art. n.º	EUR
● Preto	1008235	99,00
○ Branco	1008234	99,00

PURI 2.0  
Basic CW, Triple Round, QPAR51

MIX  
match

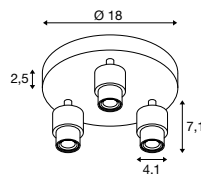

Versão	Art. n.º	EUR
● Preto	1008237	119,00
○ Branco	1008236	119,00

PURI 2.0  
Basic CW, Quadruple Long, QPAR51

MIX  
match

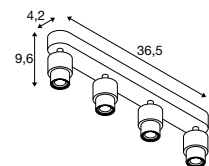

Versão	Art. n.º	EUR
● Preto	1008239	145,00
○ Branco	1008238	145,00



1008232 + 1008221 426 + 429



1008238 + 1008219 426 + 429



1008238 + 1008219 426 + 429



PURI 2.0  
Tube Abajur

MIX  
match



A: 6,5 cm  
Ø: 5,5 cm  
Material: alumínio

Versão	Art. n.º	EUR
● Preto	1008214	9,00
○ Branco	1008213	9,00
● Dourado	1008216	9,00
● Alumínio	1008376	9,00
● Cinzento	1008215	9,00
● Bronze	1008217	9,00

PURI 2.0  
Cone Abajur

MIX  
match



A: 6,5 cm  
Ø: 5,5 cm  
Material: alumínio

Versão	Art. n.º	EUR
● Preto	1008219	9,00
○ Branco	1008218	9,00
● Dourado	1008221	9,00
● Alumínio	1008377	9,00
● Cinzento	1008220	9,00
● Bronze	1008222	9,00

PURI 2.0  
Dome Abajur

MIX  
match



A: 6,5 cm  
Ø: 5,5 cm  
Material: alumínio

Versão	Art. n.º	EUR
● Preto	1008224	9,00
○ Branco	1008223	9,00
● Dourado	1008226	9,00
● Alumínio	1008378	9,00
● Cinzento	1008225	9,00
● Bronze	1008227	9,00





PURI  
CW

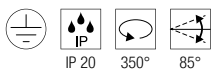

220-240V ~50/60Hz  
Material: alumínio/aço

- Anel decorativo incl.



Casquilho: 1-4xGU10



LED GU10 51 mm | 6W | 38°  
2700K | 450lm | CEE=F  
6kWh/1000h



Art. N.º: 1005077 | 7,50 EUR

PURI  
CW, single, QPAR51

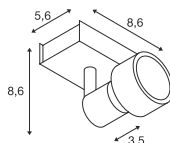

Versão	Art. n.º	EUR
● Preto	147360	39,00
○ Branco	147361	39,00

PURI  
CW, double, QPAR51

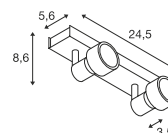

Versão	Art. n.º	EUR
● Preto	147370	79,00
○ Branco	147371	79,00

PURI  
CW, triple, QPAR51

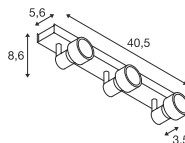

Versão	Art. n.º	EUR
● Preto	147380	109,00
○ Branco	147381	109,00

PURI  
CW, quad, QPAR51

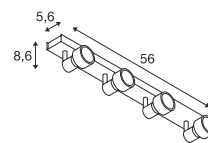

Versão	Art. n.º	EUR
● Preto	1002029	159,00
○ Branco	1002030	159,00







## AVO

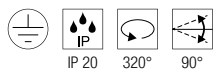

220-240V ~50/60Hz  
Material: aço



Casquilho: 1-4xGU10



LED GU10 51 mm | 6W | 38°  
2700K | 450lm | CEE=F  
6kWh/1000h



Art. N.º: 1005077 | 7,50 EUR

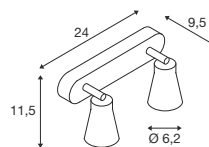
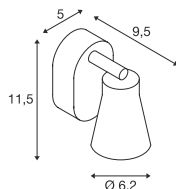

Versão	Art. n.º	EUR
● Preto	1000886	45,25
○ Branco	1000887	45,25

Versão	Art. n.º	EUR
● Preto	1000889	94,00
○ Branco	1000890	94,00

## AVO CW, triple, QPAR51

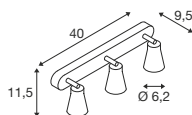

## AVO CW, quad, QPAR51

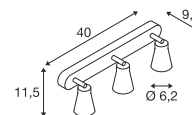

Versão	Art. n.º	EUR
● Preto	1000892	117,00
○ Branco	1000893	117,00

Versão	Art. n.º	EUR
● Preto	1000895	140,00
○ Branco	1000896	140,00



147443

435





## ASTO

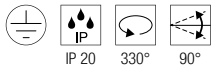

220-240V ~50/60Hz  
Material: alumínio



Casquilho: 2xGU10



LED GU10 51 mm | 6W | 38°  
2700K | 450lm | CEE=F  
6kWh/1000h



Art. N.º: 1005075 | 7,50 EUR

## ASTO CW, single, QPAR51

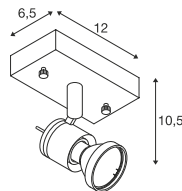

Versão	Art. n.º	EUR
● Alumínio	147441	35,75

## ASTO CW, double, QPAR51

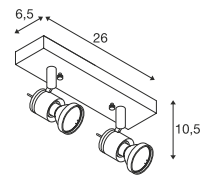

Versão	Art. n.º	EUR
● Alumínio	147442	70,00

## ASTO CW, triple, QPAR51

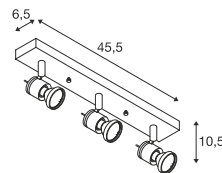

Versão	Art. n.º	EUR
● Alumínio	147443	95,00

## ASTO CW, quad, QPAR51

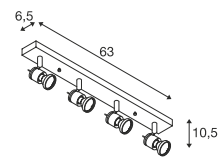

Versão	Art. n.º	EUR
● Alumínio	147444	119,00



1007591 437





PANTILHO ROPE 19  
CW, E27

PANTILHO ROPE 27  
CW, E27

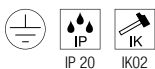
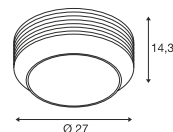
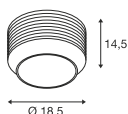

200-240V ~50/60Hz  
Material: vidro

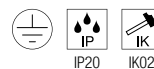

200-240V ~50/60Hz  
Material: vidro



Casquilho: 1xE27 Máx. Ø: 10 cm | C: 11 cm



Casquilho: 1xE27 Máx. Ø: 15 cm | C: 11 cm

Versão	Art. n.º	EUR
● Ambar/dourado	1007592	159,00
● Antracite/prateado	1007593	159,00

Versão	Art. n.º	EUR
● Ambar/dourado	1007591	199,00
● Antracite/prateado	1007590	199,00



A60 | 7,5W | 180°  
2700K | 720lm | CEE=F  
8kWh/1000h



Art. N.º: 1005305 | 19,00 EUR



A60 | 7,5W | 180°  
2700K | 720lm | CEE=F  
8kWh/1000h



Art. N.º: 1005305 | 19,00 EUR



1007608 + 1007610 439





### CYFT WAVE CW, PHASE

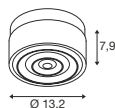

220-240V ~50/60Hz | 500mA  
Potência do sistema: 6,5W  
Material: alumínio



240lm | 2700K | 260lm | 3000K | 280lm | 4000K

Versão	Art. n.º	EUR
● Preto	1008024 ●	199,00

### CYFT CW, PHASE

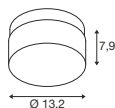

220-240V ~50/60Hz | 500mA  
Potência do sistema: 6,5W  
Material: alumínio/acrílico



330lm | 2700K | 350lm | 3000K | 380lm | 4000K

Versão	Art. n.º	EUR
● Preto	1007608	199,00

### CYFT Anel decorativo



A: 2,45 cm  
Ø: 13,1 cm  
Material: aço

Versão	Art. n.º	EUR
○ Branco	1007611	18,00
● Latão	1007610	29,90
● Cromado	1007609	25,00
● Bronze	1008025 ●	29,00
● Níquel	1008026 ●	25,00



1007718 441





**KAMI**  
CW, single, QPAR51

NEW

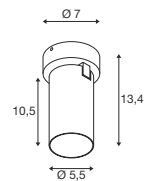

220-240V ~50/60Hz  
Material: alumínio

**SOCKET** **INSIDE** 10 W

Casquilho: 1xGU10

Máx. Ø: 5,1 cm

Versão	Art. n.º	EUR
● Preto	1007721	64,00
● Preto/dourado	1007717	64,00
○ Branco	1007720	64,00
● Branco/Preto	1007718	64,00
○ Branco/dourado	1007716	64,00



LED GU10 51 mm | 6W | 38°  
2700K | 450lm | CEE=F  
6kWh/1000h



Art. N.º: 1005077 | 7,50 EUR

1006423 443



1006428 443





### ASTO TUBE

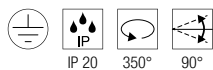

220-240V ~50/60Hz  
Material: alumínio

- Inclui refletor decorativo na cor do produto, feito de plástico reciclado
- Outros refletores decorativos coloridos disponíveis como opção



Casquilho: 1-4xGU10

### ASTO TUBE CW, single, GU10

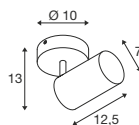

Versão	Art. n.º	EUR
● Preto	1006423	50,00
○ Branco	1006424	50,00

### ASTO TUBE CW, double, GU10

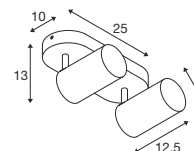

Versão	Art. n.º	EUR
● Preto	1006425	95,00
○ Branco	1006426	95,00

### ASTO TUBE Refletor decorativo



A: 3,95 cm  
Ø: 6,75 cm  
Material: policarbonato (PC)

### ASTO TUBE CW, triple, GU10

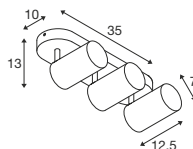

Versão	Art. n.º	EUR
● Preto	1006427	135,00
○ Branco	1006428	135,00

### ASTO TUBE CW, quadruple, GU10

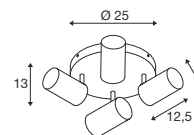

Versão	Art. n.º	EUR
● Preto	1006429	165,00
○ Branco	1006430	165,00

Versão	Art. n.º	EUR
● Cromado preto	1007190	4,00
● Dourado	1006450	4,00
● Cromado	1006449	4,00
● Cobre	1006451	4,00



1004664 445

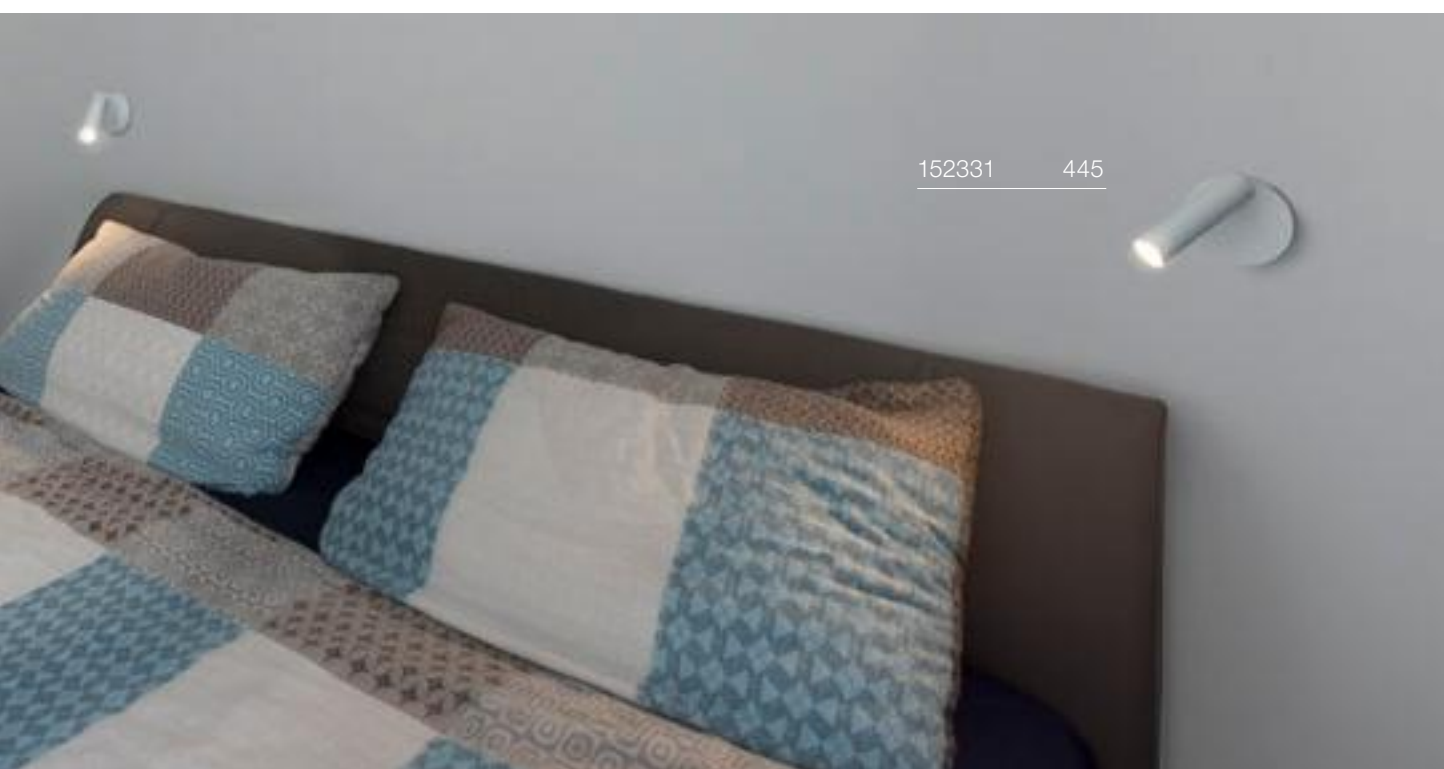

152331 445



### OCULUS CW, PHASE

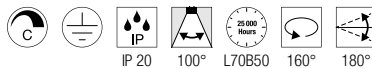
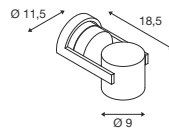

220-240V ~50/60Hz | 250mA  
Potência do sistema: 11W  
Material: alumínio/vidro

- Incluída lente fosca adicional



Down 36lm | 2000K - 780lm | 3000K

Versão	Art. n.º	EUR
● Preto	1004664	255,00
○ Branco	1004665	255,00

### KARPO 30 CW, single

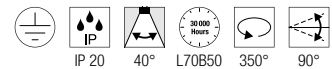
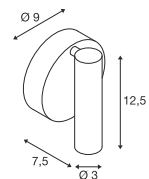

220-240V ~50/60Hz | 500mA  
Potência do sistema: 9,3W  
Material: alumínio/aço



Down 560lm | 3000K  
680lm

Versão	Art. n.º	EUR
● Preto		
560lm	152330	129,00
○ Branco		
680lm	152331	129,00





**NOBLO®**  
CW single, PHASE, DTW

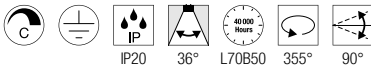
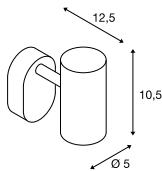

220-240V ~50/60Hz | 350  
Potência do sistema: 8W  
Material: alumínio/aço



Down 10lm | 2000K - 450lm | 3000K

Versão	Art. n.º	EUR
● Preto	1008706	119,00
○ Branco	1008703	119,00



Artigo	Art. n.º	EUR
Anel decorativo		
● Preto	1008482	5,90
○ Branco	1008483	5,90
● Dourado	1008484	5,90
● Cinzento	1008485	5,90
● Cobre	1008486	5,90
● Bronze	1008487	5,90

**NOBLO®**  
CW double, PHASE, DTW

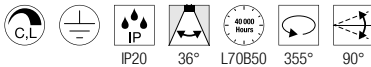
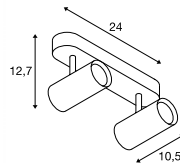

220-240V ~50/60Hz | 350  
Potência do sistema: 15W  
Material: alumínio/aço



Down 10lm | 2000K - 940lm | 3000K

Versão	Art. n.º	EUR
● Preto	1008707	189,00
○ Branco	1008704	189,00



Artigo	Art. n.º	EUR
Anel decorativo		
● Preto	1008482	5,90
○ Branco	1008483	5,90
● Dourado	1008484	5,90
● Cinzento	1008485	5,90
● Cobre	1008486	5,90
● Bronze	1008487	5,90

**NOBLO®**  
CW triple, PHASE, DTW

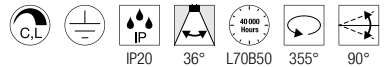
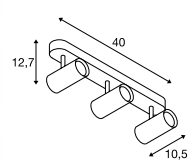

220-240V ~50/60Hz | 350  
Potência do sistema: 22W  
Material: alumínio/aço



Down 10lm | 2000K - 1360lm | 3000K

Versão	Art. n.º	EUR
● Preto	1008708	279,00
○ Branco	1008705	279,00



Artigo	Art. n.º	EUR
Anel decorativo		
● Preto	1008482	5,90
○ Branco	1008483	5,90
● Dourado	1008484	5,90
● Cinzento	1008485	5,90
● Cobre	1008486	5,90
● Bronze	1008487	5,90

1008711 449







NOBLO®  
CW single, PHASE

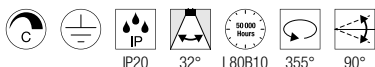
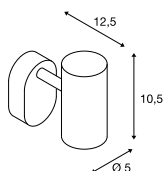

220-240V ~50/60Hz | 150  
Potência do sistema: 6W  
Material: alumínio/aço



Down 740lm | 2700K  
750lm | 3000K

Versão	Art. n.º	EUR
● Preto 750lm   3000K	<b>1008712</b>	<b>119,00</b>
● Preto 740lm   2700K	<b>1008718</b>	<b>119,00</b>
○ Branco 750lm   3000K	<b>1008709</b>	<b>119,00</b>
○ Branco 740lm   2700K	<b>1008715</b>	<b>119,00</b>

Artigo	Art. n.º	EUR
Dekoring		
● Preto	<b>1008482</b>	<b>5,90</b>
○ Branco	<b>1008483</b>	<b>5,90</b>
● Dourado	<b>1008484</b>	<b>5,90</b>
● Cinzento	<b>1008485</b>	<b>5,90</b>
● Cobre	<b>1008486</b>	<b>5,90</b>
● Bronze	<b>1008487</b>	<b>5,90</b>

NOBLO®  
CW double, PHASE

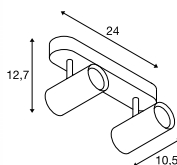

220-240V ~50/60Hz | 300  
Potência do sistema: 12W  
Material: alumínio/aço



Down 1450lm | 2700K  
1460lm | 3000K

Versão	Art. n.º	EUR
● Preto 1460lm   3000K	<b>1008713</b>	<b>189,00</b>
● Preto 1450lm   2700K	<b>1008719</b>	<b>189,00</b>
○ Branco 1460lm   3000K	<b>1008710</b>	<b>189,00</b>
○ Branco 1450lm   2700K	<b>1008716</b>	<b>189,00</b>

Artigo	Art. n.º	EUR
Dekoring		
● Preto	<b>1008482</b>	<b>5,90</b>
○ Branco	<b>1008483</b>	<b>5,90</b>
● Dourado	<b>1008484</b>	<b>5,90</b>
● Cinzento	<b>1008485</b>	<b>5,90</b>
● Cobre	<b>1008486</b>	<b>5,90</b>
● Bronze	<b>1008487</b>	<b>5,90</b>

NOBLO®  
CW triple, PHASE

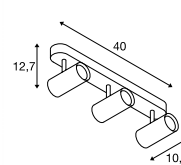

220-240V ~50/60Hz | 500  
Potência do sistema: 19W  
Material: alumínio/aço



Down 2350lm | 2700K  
2360lm | 3000K

Versão	Art. n.º	EUR
● Preto 2360lm   3000K	<b>1008714</b>	<b>279,00</b>
● Preto 2350lm   2700K	<b>1008720</b>	<b>279,00</b>
○ Branco 2360lm   3000K	<b>1008711</b>	<b>279,00</b>
○ Branco 2350lm   2700K	<b>1008717</b>	<b>279,00</b>

Artigo	Art. n.º	EUR
Dekoring		
● Preto	<b>1008482</b>	<b>5,90</b>
○ Branco	<b>1008483</b>	<b>5,90</b>
● Dourado	<b>1008484</b>	<b>5,90</b>
● Cinzento	<b>1008485</b>	<b>5,90</b>
● Cobre	<b>1008486</b>	<b>5,90</b>
● Bronze	<b>1008487</b>	<b>5,90</b>

1000131 451





# KALU

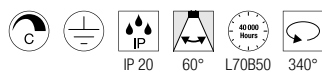

220-240V ~50/60Hz | 350mA  
Material: alumínio/policarbonato (PC)



Down

1000lm | 3000K  
2000lm | 3000K  
3000lm | 3000K  
4000lm | 3000K

## KALU CW, single, PHASE

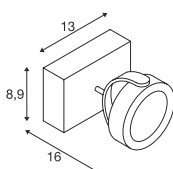

Versão	Art. n.º	EUR
● Preto		
1000lm   3000K   17W	<b>1000127</b>	<b>159,00</b>
○ Branco		
1000lm   3000K   17W	<b>1000128</b>	<b>159,00</b>

## KALU CW, double, PHASE

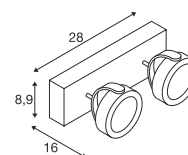

Versão	Art. n.º	EUR
● Preto		
2000lm   3000K   31W	<b>1000129</b>	<b>262,00</b>
○ Branco		
2000lm   3000K   31W	<b>1000130</b>	<b>262,00</b>

## KALU CW, triple, PHASE

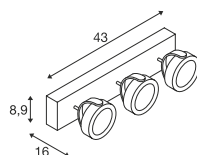

Versão	Art. n.º	EUR
● Preto		
3000lm   3000K   44W	<b>1000131</b>	<b>398,00</b>
○ Branco		
3000lm   3000K   44W	<b>1000132</b>	<b>398,00</b>

## KALU CW, quad, PHASE

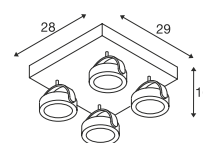

Versão	Art. n.º	EUR
● Preto		
4000lm   3000K   60W	<b>1000135</b>	<b>494,00</b>
○ Branco		
4000lm   3000K   60W	<b>1000136</b>	<b>494,00</b>

147321 453





## KALU

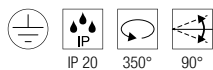

220-240V ~50/60Hz  
Material: alumínio



Casquilho: 1xGU10



QPAR111 | 8W | 38°  
2700K | 680lm | CEE=F  
8kWh/1000h



Art. N.º: 1005274 | 29,90 EUR

## KALU CW, single, QPAR111

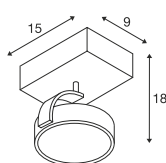

Versão	Art. n.º	EUR
● Preto	1000702	75,00
○ Branco	147301	75,00
● Alumínio	147306	78,00

## KALU CW, double, QPAR111

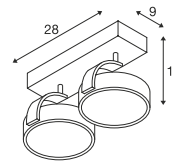

Versão	Art. n.º	EUR
● Preto	1000703	149,00
○ Branco	147311	149,00
● Alumínio	147316	159,00

## KALU CW, triple, QPAR111

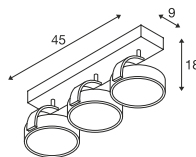

Versão	Art. n.º	EUR
● Preto	1000704	206,00
○ Branco	147321	206,00
● Alumínio	147326	217,00

## KALU CW, quad, QPAR111

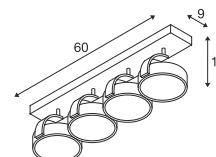

Versão	Art. n.º	EUR
● Preto	1002023	289,00
○ Branco	1002024	289,00
● Alumínio	1002025	299,00



152010 455



**ENOLA B**  
CW, single, QPAR51

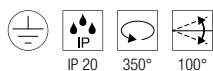
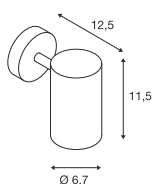

220-240V ~50/60Hz  
Material: alumínio/aço

- Anel decorativo na cor da luminária incl.
- Anel decorativo preto opcional disponível como acessório.



Casquilho: 1xGU10

Máx. C: 6,7 cm

Versão	Art. n.º	EUR
● Preto	152010	73,00
○ Branco	152011	73,00



LED GU10 51 mm | 6W | 38°  
2700K | 450lm | CEE=F  
6kWh/1000h



Art. N.º: 1005077 | 7,50 EUR



Artigo	Art. n.º	EUR
Anel decorativo		
● Preto	151840	8,95

**ENOLA B**  
CW, double, QPAR51

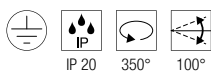
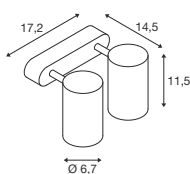

220-240V ~50/60Hz  
Material: alumínio/aço

- Anel decorativo na cor da luminária incl.
- Anel decorativo preto opcional disponível como acessório.



Casquilho: 2xGU10

max. L: 6,7 cm

Versão	Art. n.º	EUR
● Preto	152020	125,00
○ Branco	152021	125,00



LED GU10 51 mm | 6W | 38°  
2700K | 450lm | CEE=F  
6kWh/1000h



Art. N.º: 1005077 | 7,50 EUR



Artigo	Art. n.º	EUR
Anel decorativo		
● Preto	151840	8,95

**ENOLA B**  
CW, double, QPAR51

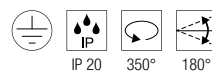
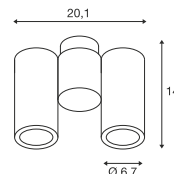

220-240V ~50/60Hz  
Material: alumínio/aço

- Anel decorativo na cor da luminária incl.
- Anel decorativo preto opcional disponível como acessório.



Casquilho: 2xGU10

Máx. C: 8 cm

Versão	Art. n.º	EUR
● Preto	151830	156,00
○ Branco	151831	156,00



LED GU10 51 mm | 6W | 38°  
2700K | 450lm | CEE=F  
6kWh/1000h



Art. N.º: 1005077 | 7,50 EUR



Artigo	Art. n.º	EUR
Anel decorativo		
● Preto	151840	8,95

1002215 456



## ALTRA DICE CW, double, QPAR51

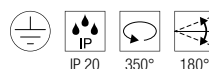
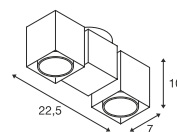

220-240V ~50/60Hz  
Material: alumínio/aço

**SOCKET**  
**INSIDE** <50  
W

Casquilho: 2xGU10

Versão	Art. n.º	EUR
● Preto	1002215	109,00
○ Branco	151531	109,00



LED GU10 51 mm | 6W | 36°  
2200-2700K | 360lm | CEE=G  
6kWh/1000h



Art. N.º: 1005273 | 9,99 EUR





**SPOT 79**  
CW, QPAR51

**INDA**  
CW, QPAR51

147551

457

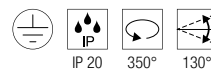
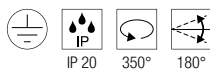
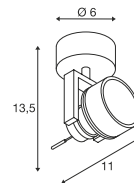
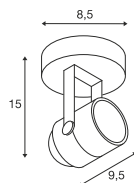

220-240V ~50/60Hz  
Material: alumínio

220-240V ~50/60Hz  
Material: alumínio



Casquilho: 1xGU10 Máx. Ø: 5,1 cm | C: 5,7 cm

Casquilho: 1xGU10 Máx. Ø: 5,1 cm | C: 5,7 cm

Versão	Art. n.º	EUR
● Preto	132020	32,75
○ Branco	132021	32,75
● Cinzento	132024	32,75

Versão	Art. n.º	EUR
● Preto	147550	65,00
○ Branco	147551	65,00
● Alumínio	147559	69,00



LED GU10 51 mm | 6W | 38°  
2700K | 450lm | CEE=F  
6kWh/1000h



Art. N.º: 1005077 | 7,50 EUR



LED GU10 51 mm | 6W | 38°  
2700K | 450lm | CEE=F  
6kWh/1000h



Art. N.º: 1005077 | 7,50 EUR





**SENSER 12**  
CW, Quadrado, PHASE

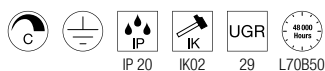
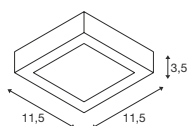

220-240V ~50/60Hz | 200mA  
Potência do sistema: 8,4W  
Material: alumínio



Down 460lm | 3000K

Versão	Art. n.º	EUR
<input type="radio"/> Branco	<b>1003017</b>	<b>74,00</b>

**SENSER 18**  
CW, Quadrado, PHASE

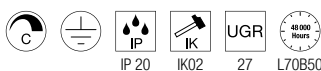
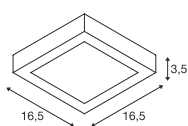

220-240V ~50/60Hz | 350mA  
Potência do sistema: 13W  
Material: alumínio



Down 840lm | 3000K

Versão	Art. n.º	EUR
<input type="radio"/> Branco	<b>1003018</b>	<b>79,00</b>

**SENSER 24**  
CW, Quadrado, PHASE

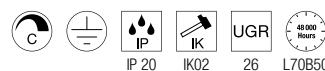
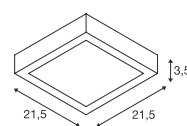

220-240V ~50/60Hz | 500mA  
Potência do sistema: 15W  
Material: alumínio



Down 1140lm | 3000K  
1240lm | 4000K

Versão	Art. n.º	EUR
<input type="radio"/> Branco		
1140lm   3000K	<b>1003019</b>	<b>85,00</b>
<input type="radio"/> Branco		
1240lm   4000K	<b>1004705</b>	<b>85,00</b>





**SENSER 12**  
CW, Redondo, PHASE

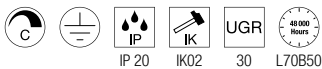
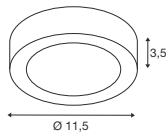

220-240V ~50/60Hz | 200mA  
Potência do sistema: 8,4W  
Material: alumínio



Down 460lm | 3000K  
470lm | 4000K

Versão	Art. n.º	EUR
○ Branco		
460lm   3000K   8.4W	<b>1003014</b>	<b>74,00</b>
○ Branco		
470lm   4000K   8.2W	<b>1004700</b>	<b>74,00</b>

**SENSER 18**  
CW, Redondo, PHASE

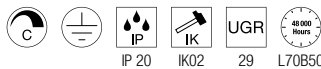
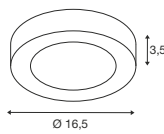

220-240V ~50/60Hz | 350mA  
Potência do sistema: 13W  
Material: alumínio



Down 830lm | 3000K  
990lm | 4000K

Versão	Art. n.º	EUR
○ Branco		
830lm   3000K   13W	<b>1003015</b>	<b>79,00</b>
○ Branco		
990lm   4000K   12W	<b>1004701</b>	<b>79,00</b>

**SENSER 24**  
CW, Redondo, PHASE

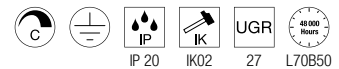
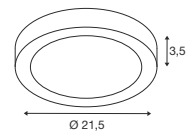

220-240V ~50/60Hz | 500mA  
Potência do sistema: 15W  
Material: alumínio



Down 1140lm | 3000K  
1300lm | 4000K

Versão	Art. n.º	EUR
○ Branco		
1140lm   3000K   15W	<b>1003016</b>	<b>85,00</b>
○ Branco		
1300lm   4000K   15W	<b>1004702</b>	<b>85,00</b>

SIMA  
CW, Redondo, Sensor

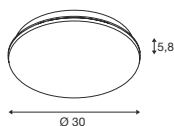

220-240V ~50/60Hz | 320mA  
Potência do sistema: 24W  
Material: policarbonato (PC)



Down 2200lm | 3000K

Versão	Art. n.º	EUR
○ Branco	1005086	176,00

SIMA  
CW, Redondo, PHASE

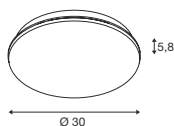

220-240V ~50/60Hz | 320mA  
Potência do sistema: 24W  
Material: policarbonato (PC)



Down 2200lm | 3000K

Versão	Art. n.º	EUR
○ Branco	1005085	152,00

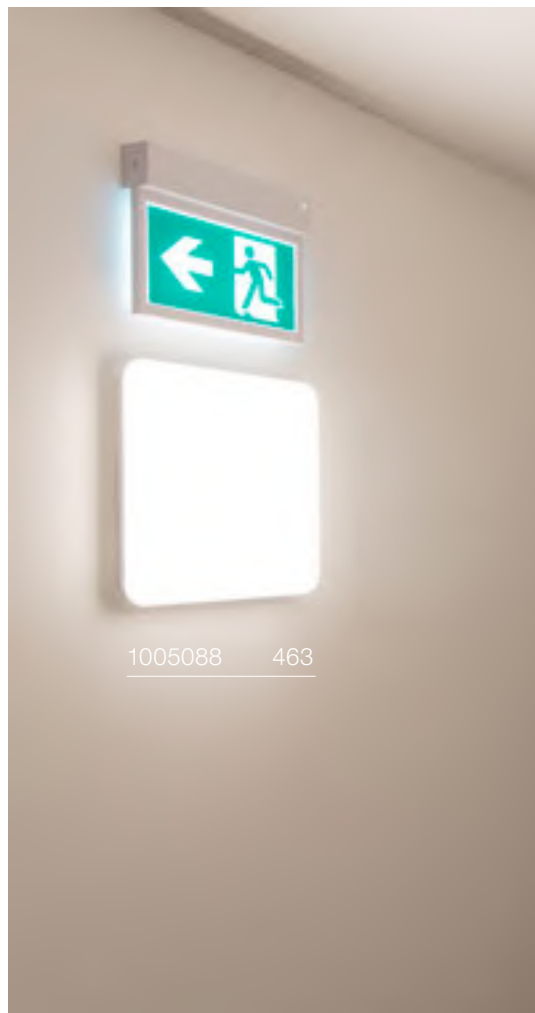
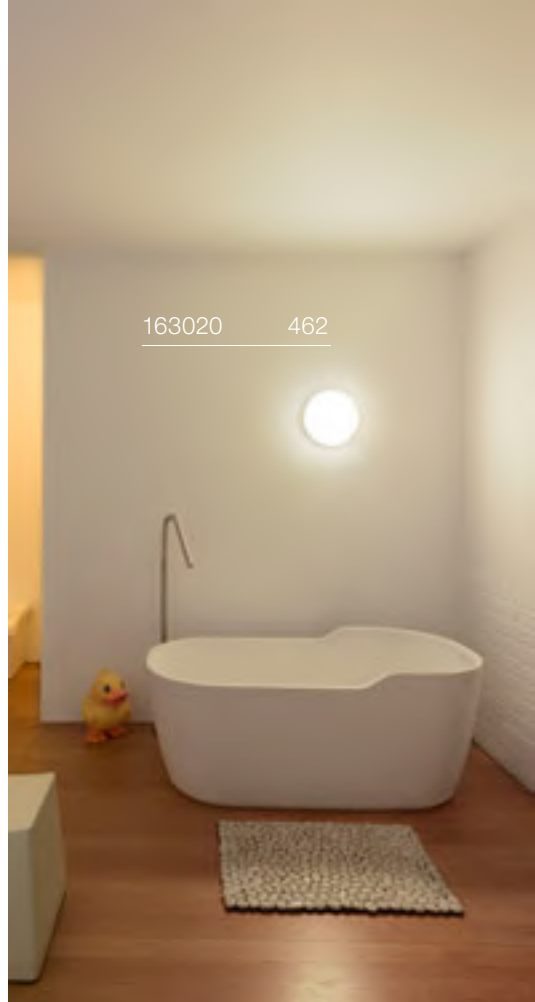

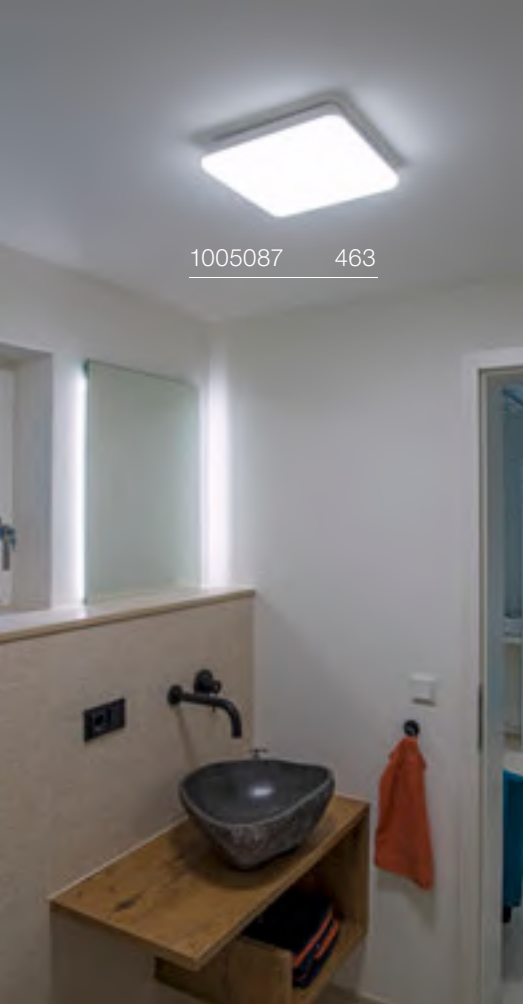

1005087 463

**SIMA**  
CW, Quadrado, Sensor

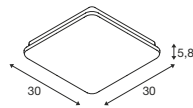

**SIMA**  
CW, Quadrado, PHASE

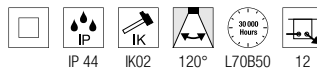
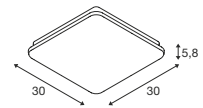

220-240V ~50/60Hz | 320mA  
Potência do sistema: 24W  
Material: policarbonato (PC)



220-240V ~50/60Hz | 320mA  
Potência do sistema: 24W  
Material: policarbonato (PC)



Down 2200lm | 3000K

Versão	Art. n.º	EUR
○ Branco	1005088	176,00



Down 2200lm | 3000K

Versão	Art. n.º	EUR
○ Branco	1005087	152,00



1002021 465







LIPSY® 30  
CW, Dome

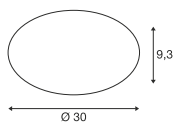
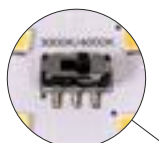

220-240V ~50/60Hz | 350mA  
Potência do sistema: 13,5W  
Material: alumínio/policarbonato (PC)



Down 1550lm | 3000K | 1600lm | 4000K

Versão	Art. n.º	EUR
○ Branco	1002020	90,00

LIPSY® 40  
CW, Dome

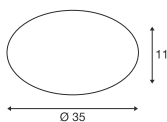

220-240V ~50/60Hz | 500mA  
Potência do sistema: 17,5W  
Material: alumínio/policarbonato (PC)



Down 2050lm | 3000K | 2200lm | 4000K

Versão	Art. n.º	EUR
○ Branco	1002021	111,00

LIPSY® 50  
CW, Dome

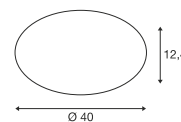
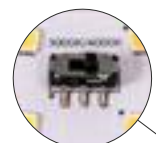

220-240V ~50/60Hz | 500mA  
Potência do sistema: 20W  
Material: alumínio/policarbonato (PC)



Down 2500lm | 3000K | 2700lm | 4000K

Versão	Art. n.º	EUR
○ Branco	1002022	121,00

1002076 467





LIPSY® 30  
CW, Drum

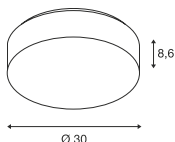
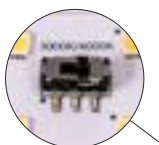

220-240V ~50/60Hz | 350mA  
Potência do sistema: 13,5W  
Material: alumínio/policarbonato (PC)



Down 1600lm | 3000K | 1650lm | 4000K

Versão	Art. n.º	EUR
○ Branco	1002075	100,00

LIPSY® 40  
CW, Drum

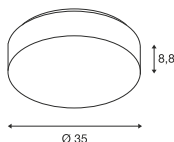
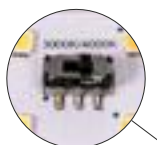

220-240V ~50/60Hz | 500mA  
Potência do sistema: 17,5W  
Material: alumínio/policarbonato (PC)



Down 2100lm | 3000K | 2300lm | 4000K

Versão	Art. n.º	EUR
○ Branco	1002076	111,00

LIPSY® 50  
CW, Drum

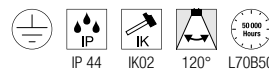
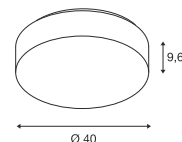

220-240V ~50/60Hz | 500mA  
Potência do sistema: 20W  
Material: alumínio/policarbonato (PC)



Down 2450lm | 3000K | 2600lm | 4000K

Versão	Art. n.º	EUR
○ Branco	1002077	121,00



1002940 468



1002941 468

### LIPSY® 40 CW, Drum, DALI

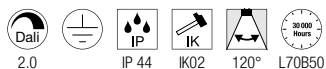
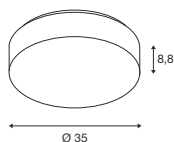
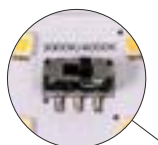

220-240V ~50/60Hz | 500mA  
Potência do sistema: 18W  
Material: alumínio/policarbonato (PC)



Down 2100lm | 3000K | 2300lm | 4000K

Versão	Art. n.º	EUR
○ Branco	1002940	201,00

### LIPSY® 50 CW, Drum, DALI

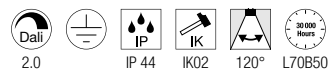
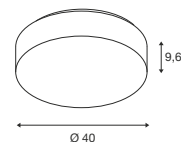

220-240V ~50/60Hz | 500mA  
Potência do sistema: 21W  
Material: alumínio/policarbonato (PC)



Down 2450lm | 3000K | 2600lm | 4000K

Versão	Art. n.º	EUR
○ Branco	1002941	212,00



MELAN  
CW, E27

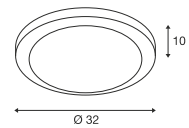

220-240V ~50/60Hz  
Material: alumínio/vidro

**SOCKET**  
**INSIDE** <60  
W

Casquilho: 1xE27 Máx. Ø: 7 cm | C: 16 cm

Versão	Art. n.º	EUR
● Alumínio	155236	122,00



A60 | 7,5W | 320°  
2700K | 800lm | CEE=F  
8kWh/1000h



Art. N.º: 1005303 | 9,60 EUR



155236 469

1006124 471





### BATTEN 60 CW

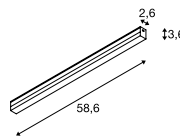

220-240V ~50/60Hz | 110mA  
Potência do sistema: 9W  
Material: policarbonato (PC)

- Interruptor no corpo da luminária
- Alimentador excl.



Down 940lm | 3000K | 980lm | 4000K

Versão	Art. n.º	EUR
<input type="radio"/> Branco	1006123	53,00



Artigo	Art. n.º	EUR
Conector direto		
<input type="radio"/> Branco	1006128	2,40
Alimentador		
<input type="radio"/> Branco	1006125	10,40
Fixações de montagem, 2 unidades		
<input type="radio"/> Branco	1006126	2,00
Conector		
<input type="radio"/> Branco	1006127	5,80

### BATTEN 120 CW

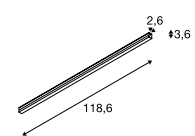

220-240V ~50/60Hz | 220mA  
Potência do sistema: 18W  
Material: policarbonato (PC)

- Interruptor no corpo da luminária
- Alimentador excl.



Down 1900lm | 3000K | 1960lm | 4000K

Versão	Art. n.º	EUR
<input type="radio"/> Branco	1006124	66,00



Artigo	Art. n.º	EUR
Conector direto		
<input type="radio"/> Branco	1006128	2,40
Alimentador		
<input type="radio"/> Branco	1006125	10,40
Fixações de montagem, 2 unidades		
<input type="radio"/> Branco	1006126	2,00
Conector		
<input type="radio"/> Branco	1006127	5,80



**SPORTCLUB**  
**HET EILAND**



1001020 473







## LONG GRILL CW

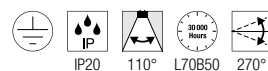
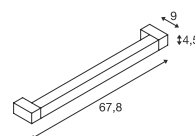

220-240V ~50/60Hz | 700mA  
Potência do sistema: 20W  
Material: alumínio/acrílico



Down

1600lm | 3000K

Versão	Art. n.º	EUR
● Preto	1001020	297,00
○ Branco	1001019	297,00





### SIGHT 60 CW

### SIGHT 115 CW

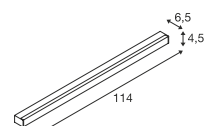
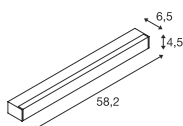
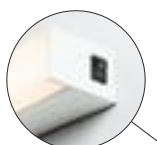

220-240V ~50/60Hz | 700mA  
Potência do sistema: 20W  
Material: alumínio/acrílico

220-240V ~50/60Hz | 700mA  
Potência do sistema: 38W  
Material: alumínio/acrílico

- Interruptor no corpo da luminária



Down 1490lm | 3000K

Down 3100lm | 3000K

Versão	Art. n.º	EUR
● Preto	1001283	232,00
○ Branco	1001284	232,00

Versão	Art. n.º	EUR
● Preto	1001286	323,00
○ Branco	1001287	323,00

1008109 + 1007860 478 + 479





NEW



**SCKET**

VARYT | 478

NEW



VARYT | 479

NEW



VARYT | 479

NEW



VARYT | 479

NEW



VARYT | 479

NEW



**LED**

QUIMERA | 481



**LED**

ONE STRAIGHT | 483



**LED**

ONE BOW | 483



**LED**

VINOLINA ONE | 485



**LED**

VINOLINA | 485



**LED**

VINOLINA TWO | 487



**LED**

TAHA | 489



**SCKET**

TINY SUN | 491



**SCKET**

LITTLE SUN | 491



**LED**

WORKLIGHT PRO | 492



**LED**

WORKLIGHT PRO | 492



**LED**

WORKLIGHT | 493



**LED**

WORKLIGHT | 493



**SCKET**

FENDA | 495



**SCKET**

FENDA | 495



**SCKET**

FENDA | 495



**SCKET**

FENDA | 497



FENDA | 497



FENDA | 497



FENDA | 497



FENDA | 497



**LED**

KARPO | 498



**LED**

KARPO | 498



**SCKET**

PHELIA | 499

# VARYT TL, E14

MIX  
match

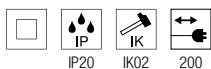
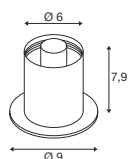

220-240V ~50/60Hz  
Material: alumínio

- PT Ficha europeia e interruptores



Base: 1xE14 máx. Ø: 11 cm C: 3,8 cm

Versão	Art. n.º	EUR
● Preto	1008109	89,00
○ Branco	1008110	89,00
● Latão (PVD)	1008112	119,00
● Cromado	1008111	99,00
● Cobre (PVD)	1008113	119,00



C35 | 4,2W | 320°  
2700K | 380lm | CEE=F  
5kWh/1000h



Art. N.º: 1005284 | 6,50 EUR



1008109 + 1007859 478 + 479



1008110 + 1008119 478 + 479



**VARYT**  
Difusor em vidro p/ PD, WL, CL, TL

MIX  
match



A: 12,8 cm  
Ø: 12 cm  
Material: vidro

Versão	Art. n.º	EUR
○ Branco	1008119 ●	59,00

**VARYT**  
Difusor em vidro diamante  
p/ PD, WL, CL, TL

MIX  
match

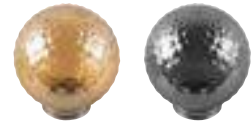

A: 12,7 cm  
Ø: 12 cm  
Material: vidro

Versão	Art. n.º	EUR
● Âmbar	1008023 ●	79,00
● Smoke	1007858 ●	79,00



**VARYT**  
Difusor em vidro linha  
p/ PD, WL, CL, TL

MIX  
match



A: 13 cm  
Ø: 12 cm  
Material: vidro

Versão	Art. n.º	EUR
○ Branco	1007859 ●	69,00

**VARYT**  
Difusor em vidro plissado  
p/ PD, WL, CL, TL

MIX  
match



A: 13,5 cm  
Ø: 11,5 cm  
Material: vidro

Versão	Art. n.º	EUR
○ Branco	1007860 ●	75,00

1008033 223



1008038 481







## QUIMERA TL



NEW

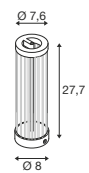

220-240V ~50/60Hz | 350mA  
Potência do sistema: 4,3W  
Material: alumínio/vidro



Down 110lm | 2700K | 120lm | 3000K

Versão	Art. n.º	EUR
● Latão (PVD)	<b>1008039</b>	● <b>329,00</b>
● Cobre escuro (PVD)	<b>1008040</b>	● <b>329,00</b>
● Bronze escuro (PVD)	<b>1008038</b>	● <b>329,00</b>

1006353 483



1006355 483

1006352 483





## ONE STRAIGHT FL

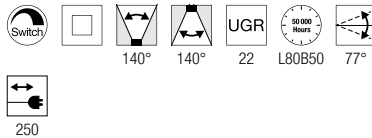
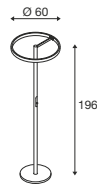

220-240V ~50/60Hz | 24V  
Potência do sistema: 22W  
Material: aço/policarbonato (PC)

• Ficha Euro



Up	600lm	2700K	600lm	3000K
Down	600lm		600lm	

Versão	Art. n.º	EUR
● Preto	1006355	849,00
● Preto/latão	1006353	849,00
○ Branco	1006354	849,00

## ONE BOW FL

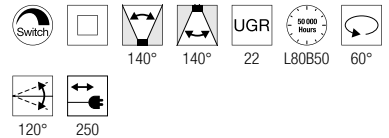
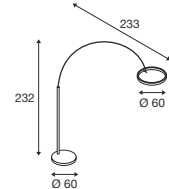

220-240V ~50/60Hz | 24V  
Potência do sistema: 22W  
Material: aço/policarbonato (PC)

• Ficha Euro



Up	600lm	2700K	600lm	3000K
Down	600lm		600lm	

Versão	Art. n.º	EUR
● Preto	1006352	1.249,00
● Preto/latão	1006350	1.249,00
○ Branco	1006351	1.249,00



1007357 485

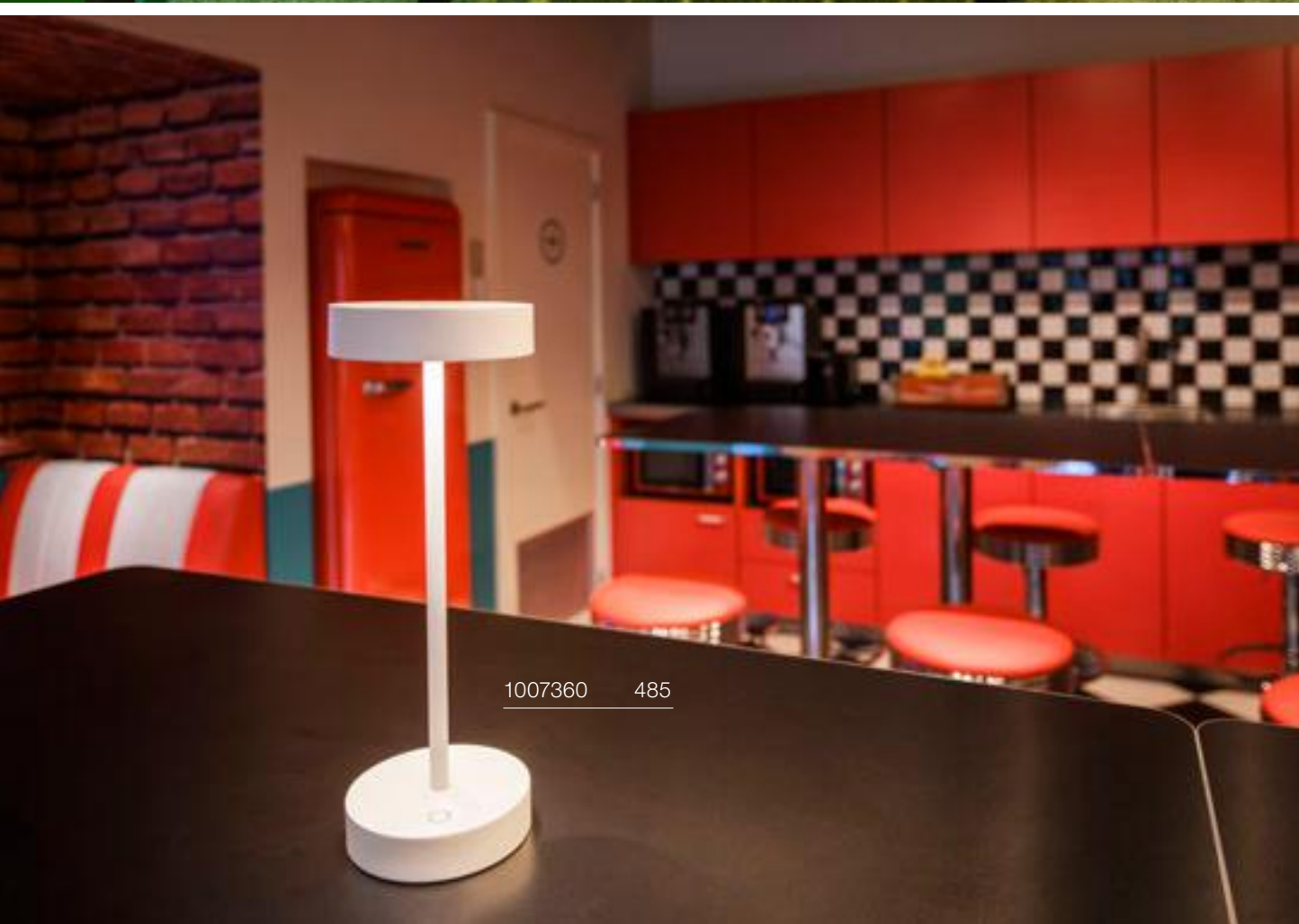

1007360 485



## VINOLINA ONE TL, Acumulador

## VINOLINA TL, Acumulador

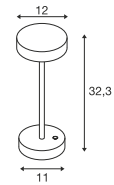
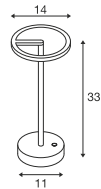

IP54 L80B10

Funcionamento a bateria de 5V  
Potência do sistema: 2,5W  
Material: alumínio

- Duração 12h
- Tempo de carregamento 7h
- Inclui placa de carregamento
- Não inclui fonte de alimentação
- USB A



IP54 L80B10

Funcionamento a bateria de 5V  
Potência do sistema: 2,2W  
Material: alumínio

- Duração 12h
- Tempo de carregamento 7h
- Inclui placa de carregamento
- Não inclui fonte de alimentação
- USB A



Down 125lm | 2700K

Versão	Art. n.º	EUR
● Preto	1007359	99,00
○ Branco	1007357	99,00
● Oxidado	1007358	99,00



Down 130lm | 2700K | 130lm | 3000K

Versão	Art. n.º	EUR
● Preto	1007362	99,00
○ Branco	1007360	99,00
● Oxidado	1007361	99,00



1007696 487



## VINOLINA TWO TL, Acumulador, DTW

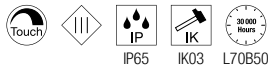
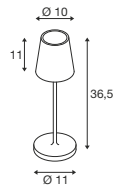

Funcionamento a bateria de 5V  
Potência do sistema: 2W  
Material: alumínio/plástico

- Duração 10h
- Tempo de carregamento 5h
- Inclui estação de carregamento para uma luminária



140lm | 2200K | 170lm | 2700K | 190lm | 3000K

Versão	Art. n.º	EUR
● Preto	1007693	99,00
○ Branco	1007692	99,00
● Areia	1007697	99,00
● Oxidado	1007695	99,00
● Vermelho	1007694	99,00
● Verde-limão	1007696	99,00

## VINOLINA TWO Base de carregamento

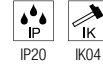

220-240V ~50/60Hz | 5V  
Potência do sistema: 37W  
Material: plástico/plástico

C: 46,2 cm  
L: 32,6 cm  
A: 5 cm

- Base de carregamento para máx. 6 VINOLINA TWO
- Cabo de ligação disponível em separado

Versão	Art. n.º	EUR
● Preto	1007698	139,00

## VINOLINA TWO Cabo de ligação IEC com ficha de segurança



C: 180 cm

Versão	Art. n.º	EUR
● Preto	1008029	14,90



1007380 489





## TAHA

Conjunto de luminárias, BATERIA

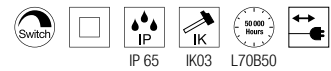
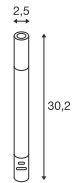

100-240V ~50/60Hz | Funcionamento a bateria de 5V  
 Potência do sistema: 5W  
 Máx. Controlador com saída em U: 5V DC  
 Material: alumínio/plástico

- 3 níveis reguláveis
- Transformador de tomada



Down

200lm | 2700K

Versão	Art. n.º	EUR
● Preto	1007380	159,00



1007366 491



## TINY SUN TL

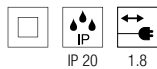
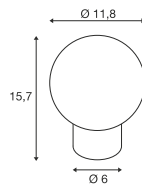

220-240V ~50/60Hz  
Material: aço

- Ficha Euro e interruptor
- Cabo em tecido



Base: 1xG9 máx. Ø: 1,9 cm C: 6 cm

Versão	Art. n.º	EUR
● Cobre	1007364	99,00
● Bronze	1007363	99,00



LED QT14 | 3,6W | 300°  
K2700K | 450lm | CEE=E  
4kWh/1000h

Art. N.º: 1007455 | 8,80 EUR

## LITTLE SUN TL

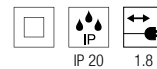
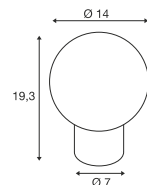

220-240V ~50/60Hz  
Material: aço

- Ficha Euro e interruptor
- Cabo em tecido



Base: 1xG9 máx. Ø: 1,9 cm C: 6 cm

Versão	Art. n.º	EUR
● Cobre	1007366	109,00
● Bronze	1007365	109,00



LED G9 | 3,6W | 300°  
3000K | 400lm | CEE=E  
4kWh/1000h

Art. N.º: 1005286 | 8,80 EUR

**WORKLIGHT PRO**  
FL, single

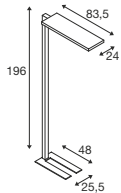

L80B10 250

200-240V ~50/60Hz | 48V  
Potência do sistema: 100W  
Material: alumínio/aço

- Ficha de segurança
- Sensor incl.



Up 10700lm | 4000K  
Down 2300lm

Versão	Art. n.º	EUR
● Preto	1007462	950,00
○ Branco	1007463	950,00
● Cinzento	1007464	950,00

**WORKLIGHT PRO**  
FL, double

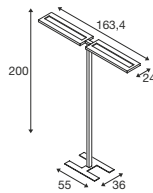

L80B10 250

200-240V ~50/60Hz | 48V  
Potência do sistema: 150W  
Material: alumínio/aço

- Ficha de segurança
- Sensor incl.



Up 15600m | 4000K  
Down 4400lm

Versão	Art. n.º	EUR
● Preto	1007465	1.749,00
○ Branco	1007466	1.749,00
● Cinzento	1007467	1.749,00

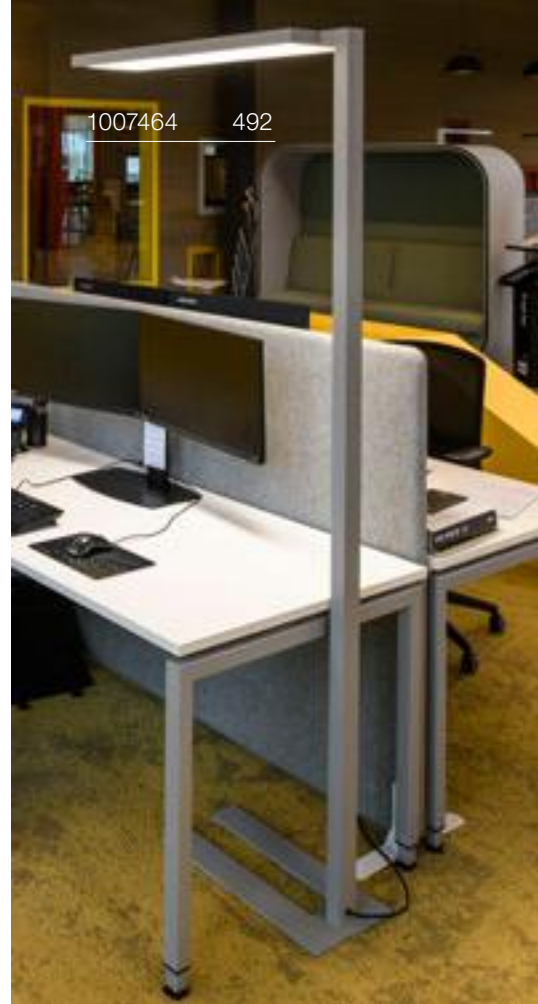



1007465 492



## WORKLIGHT FL

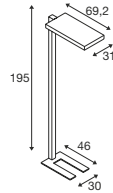

L80B10 250

200-240V ~50/60Hz | 2000mA  
Potência do sistema: 79W  
Material: alumínio

- Ficha de segurança



Up 3800lm | 4000K  
Down 3800lm

Versão	Art. n.º	EUR
● Preto	1005390	799,00
○ Branco	1005391	799,00
○ Prateado	1006343	799,00

## WORKLIGHT TL

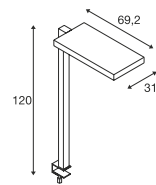

L80B10 250

200-240V ~50/60Hz | 2000mA  
Potência do sistema: 79W  
Material: alumínio

- Alcance de fixação de: 6-40 mm
- Ficha de segurança



Up 3800lm | 4000K  
Down 3800lm

Versão	Art. n.º	EUR
● Preto	1005392	699,00
○ Branco	1005394	699,00
○ Prateado	1006344	699,00

1006344 493





132660 + 1000580    300 + 497

155790 + 155592    495 + 497

155780 + 155592    495 + 497

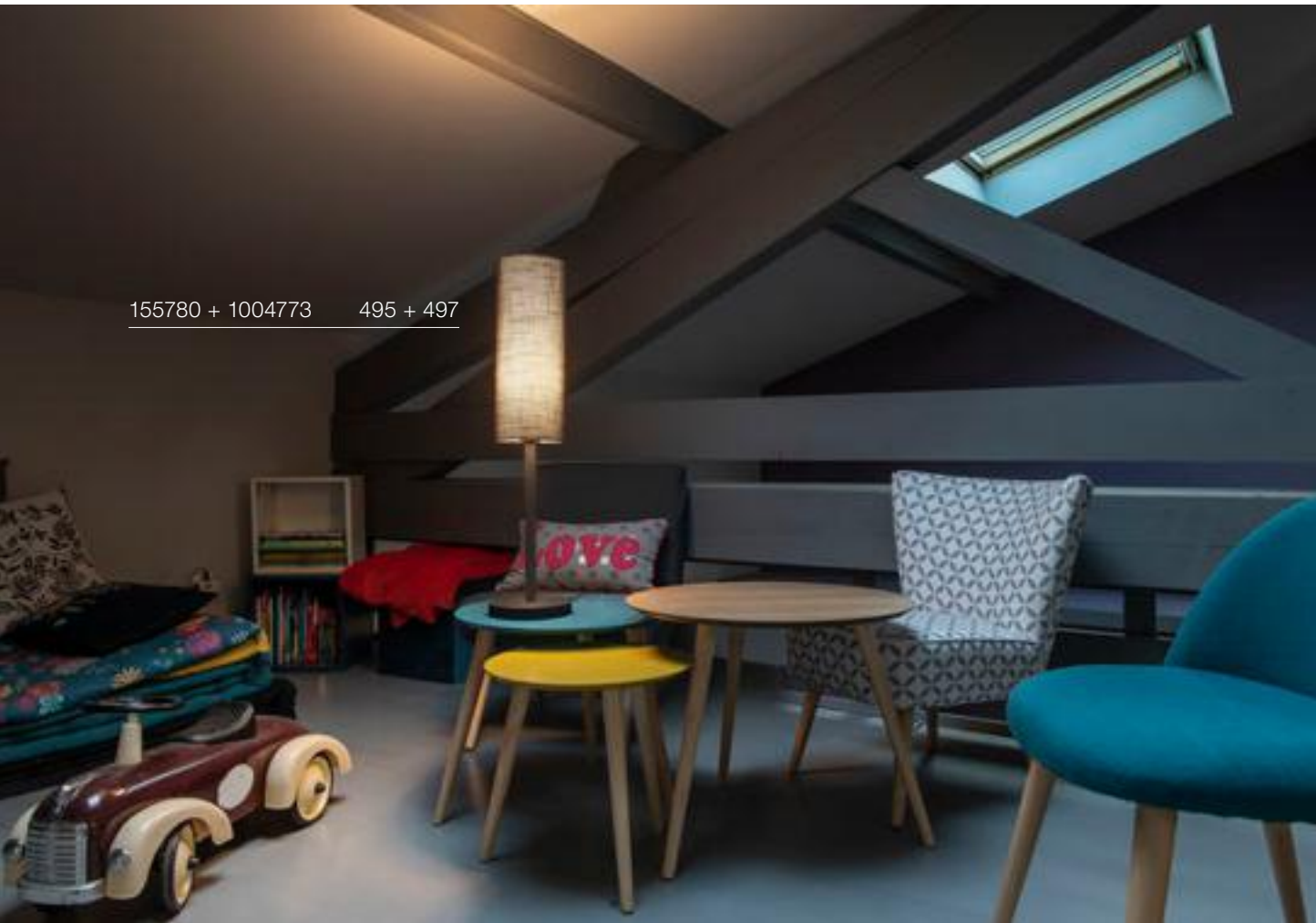

155780 + 1004773    495 + 497



## FENDA TL, E27

MIX  
match

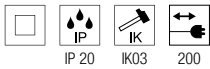
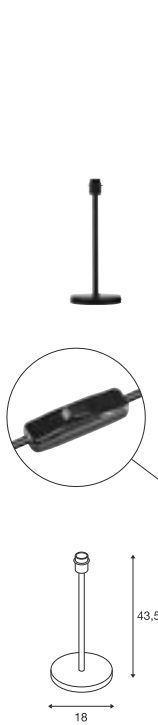

220-240V ~50/60Hz  
Material: aço

- Ficha Euro e interruptor
- Pode encontrar abajures a condizer na página 497

**SOCKET INSIDE** <60 W

Base: 1xE27

Versão	Art. n.º	EUR
● Preto	155780	80,00



A60 | 7,5W | 320°  
2700K | 800lm | CEE=F  
8kWh/1000h



Art. N.º: 1005303 | 9,60 EUR

## FENDA FL, E27

MIX  
match

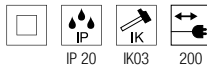

220-240V ~50/60Hz  
Material: aço/plástico

- Ficha Euro e interruptor
- Pode encontrar abajures a condizer na página 497

**SOCKET INSIDE** <60 W

Base: 1xE27

Versão	Art. n.º	EUR
● Preto	155790	141,00



A60 | 7,5W | 320°  
2700K | 800lm | CEE=F  
8kWh/1000h



Art. N.º: 1005303 | 9,60 EUR

## FENDA TL, E27

MIX  
match

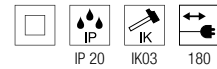
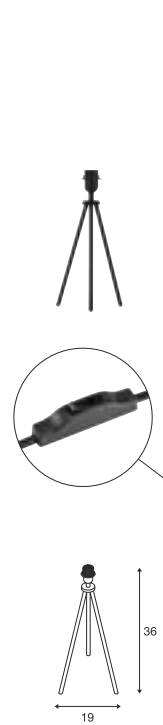

220-240V ~50/60Hz  
Material: alumínio/plástico

- Ficha Euro e interruptor
- Pode encontrar abajures a condizer na página 497

**SOCKET INSIDE** <40 W

Base: 1xE27

Versão	Art. n.º	EUR
● Preto	155540	80,00



LED E27 | 7,5W | 320°  
2500K | 700lm | CEE=F  
8kWh/1000h



Art. N.º: 1005265 | 26,50 EUR



155490 + 1004775 497





## FENDA FL, E27

MIX  
match

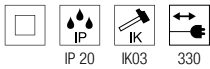
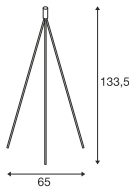
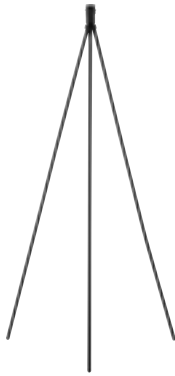

220-240V ~50/60Hz  
Material: alumínio

- Interruptor na cabeça da luminária
- Ficha Euro



Base: 1xE27

Versão	Art. n.º	EUR
● Preto	155490	132,00



LED E27 | 13,2W | 220°  
2700K | 1300lm | CEE=F  
13kWh/1000h



Art. N.º: 1005302 | 12,25 EUR

## FENDA 15 cm, Redondo

MIX  
match



A: 40 cm  
Ø: 15 cm  
Material: têxtil/aço

Versão	Art. n.º	EUR
● Cinzento	1004773	44,75

## FENDA 30 cm, Redondo

MIX  
match



A: 20 cm  
Ø: 30 cm  
Material: têxtil/aço

Versão	Art. n.º	EUR
● Preto/cobre	155592	70,00
○ Branco	155582	53,00
● Cinzento	1004774	53,00
● Bege	155583	53,00

## FENDA Ø 45 cm, Redondo

MIX  
match



A: 28 cm  
Ø: 45,5 cm  
Material: têxtil/aço

## FENDA Ø 70cm, Redondo

MIX  
match



A: 36 cm  
Ø: 70 cm  
Material: têxtil/aço

Versão	Art. n.º	EUR
● Preto/cobre	156122	88,00
○ Branco	156111	83,00
● Cinzento	1004775	83,00
● Bege	156113	83,00

Versão	Art. n.º	EUR
● Preto/cobre	1000580	129,00
○ Branco	1000579	112,00

KARPO  
TL

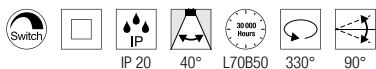
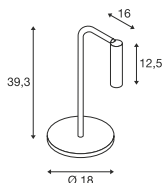

230

200-240V ~50/60Hz | 500mA  
Potência do sistema: 6,2W  
Material: alumínio

- Interruptor na cabeça da luminária
- Transformador de tomada



Down 360lm | 430lm | 3000K

Versão	Art. n.º	EUR
● Preto 360lm	1001461	186,00
○ Branco 430lm	1001460	186,00

KARPO  
FL

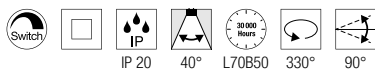
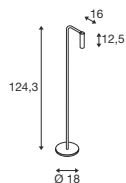

230

200-240V ~50/60Hz | 500mA  
Potência do sistema: 6,2W  
Material: alumínio

- Interruptor na cabeça da luminária
- Transformador de tomada



Down 360lm | 430lm | 3000K

Versão	Art. n.º	EUR
● Preto 360lm	1001463	242,00
○ Branco 430lm	1001462	242,00

1001463 498

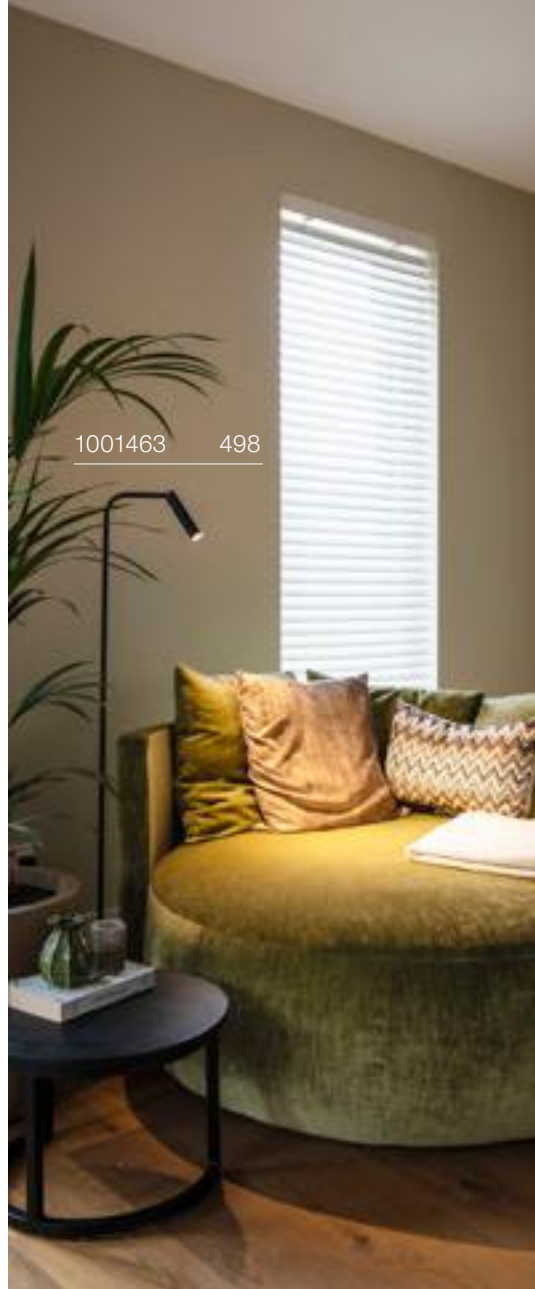

1001461 498





**PHELIA**  
FL, E27

146010 498

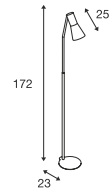

220-240V ~50/60Hz  
Material: alumínio/aço

- Interruptor na cabeça da luminária
- Ficha de segurança e interruptor



Base: 1xE27 | Máx. Ø: 5,3 cm | C: 18 cm

Versão	Art. n.º	EUR
● Preto	146010	242,00



A60 | 7,5W | 320°  
2700K | 800lm | CEE=F  
8kWh/1000h



Art. N.º: 1005303 | 9,60 EUR

1008456 531





 NUMINOS® XS | 514



 NUMINOS® S | 516



 NUMINOS® XS | 518



 NUMINOS® S | 520



 IN-LINE 22 | 523



 IN-LINE 22 | 523

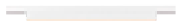

 IN-LINE 44 | 525



 IN-LINE 44 | 525



 IN-LINE 24 | 527



 IN-LINE 46 | 527



 GRIP! S | 529



 GRIP! S | 529



 GRIP! S | 529



 GRIP! S | 531



 GRIP! S | 531



 GRIP! S | 531



 LALU® PD | 533



LALU® TETRA 14 | 534



LALU® TETRA 24 | 534



LALU® ELYPSE 15 | 535



LALU® PLATE 15 | 535



LALU® CONE 15 | 535



LALU® ELYPSE 22 | 535



LALU® PLATE 22 | 535

1006623 + 1006617 525 + 523





## 48V TRACK

Calha eletrificada saliente DALI



	1 m	1 m	2 m	2 m
<b>Tensão nominal (V)</b>	48V DC	48V DC	48V DC	48V DC
<b>Intensidade máx. de corrente (A)</b>	16	16	16	16
<b>Carga mec. máx.</b>	5 kg	5 kg	10 kg	10 kg
<b>Cor</b>	● Preto	○ Branco	● Preto	○ Branco
<b>Material</b>	Alumínio	Alumínio	Alumínio	Alumínio
<b>C x L x A (cm)</b>	100 x 2,62 x 2,26	100 x 2,62 x 2,26	200 x 2,62 x 2,26	200 x 2,62 x 2,26
<b>Art. n.º</b>	<b>1006541</b>	<b>1006542</b>	<b>1006543</b>	<b>1006544</b>
<b>EUR</b>	<b>49,00</b>	<b>49,00</b>	<b>84,00</b>	<b>84,00</b>

	3 m	3 m	4 m	4 m
<b>Tensão nominal (V)</b>	48V DC	48V DC	48V DC	48V DC
<b>Intensidade máx. de corrente (A)</b>	16	16	16	16
<b>Carga mec. máx.</b>	15 kg	15 kg	20 kg	20 kg
<b>Cor</b>	● Preto	○ Branco	● Preto	○ Branco
<b>Material</b>	Alumínio	Alumínio	Alumínio	Alumínio
<b>C x L x A (cm)</b>	300 x 2,62 x 2,26	300 x 2,62 x 2,26	400 x 2,62 x 2,26	400 x 2,62 x 2,26
<b>Art. n.º</b>	<b>1006545</b>	<b>1006546</b>	<b>1006547</b>	<b>1006548</b>
<b>EUR</b>	<b>132,00</b>	<b>132,00</b>	<b>180,00</b>	<b>180,00</b>

# 48V TRACK

Calha eletrificada saliente DALI

Guia de planeamento e visão geral de acessórios

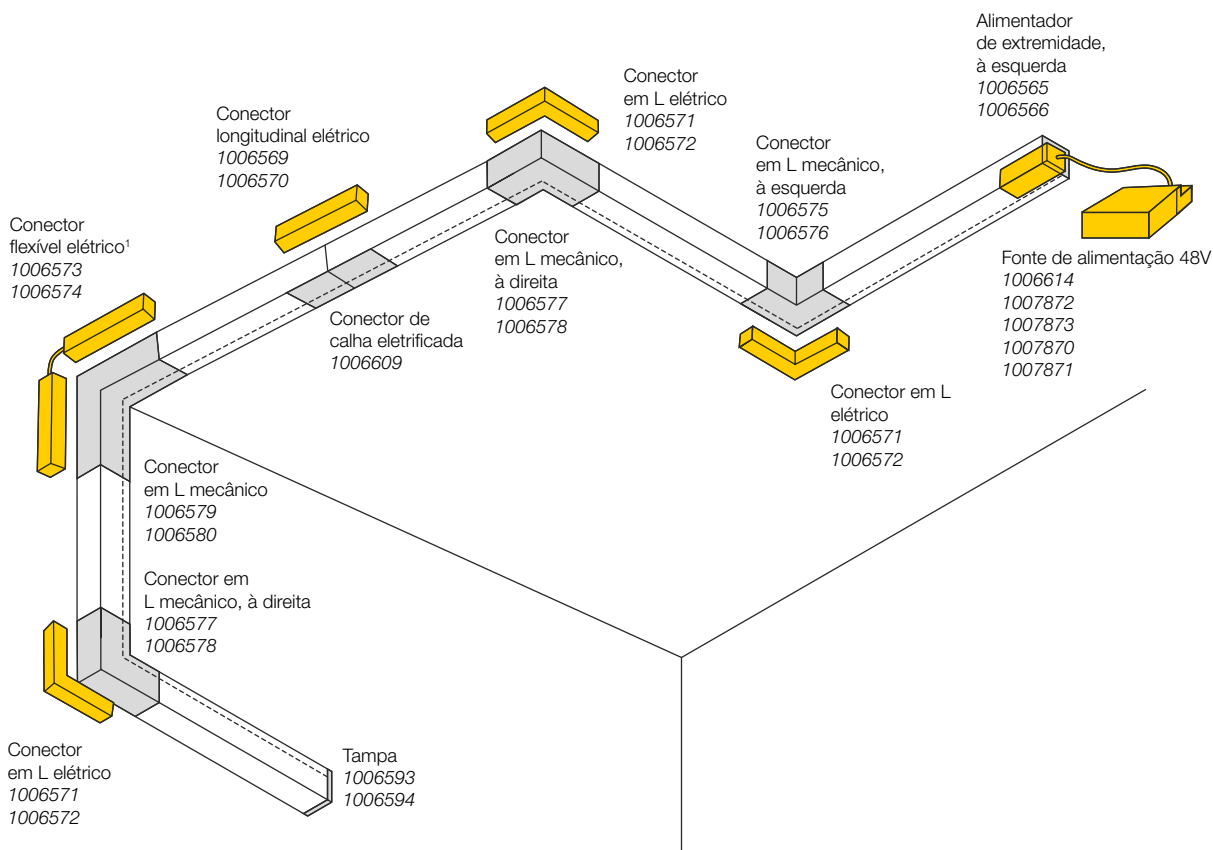

<sup>1</sup> Tenha em atenção que conectores elétricos e mecânicos têm de ser sempre instalados juntos.

## Alimentador de extremidade, à esquerda

16 A máx. | Policarbonato (PC)  
C: 9,7 cm | L: 1,6 cm | A: 1,9 cm



- Preto
- Branco

Art. n.º **1006565** **14,00 EUR**  
**1006566** **14,00 EUR**

## Alimentador de extremidade, à direita

16 A máx. | Policarbonato (PC)  
C: 9,7 cm | L: 1,6 cm | A: 1,9 cm



- Preto
- Branco

Art. n.º **1006567** **14,00 EUR**  
**1006568** **14,00 EUR**





**Conector em L mecânico, p/ calha eletrificada saliente padrão, à direita (p/ instalação no teto)**  
Alumínio  
C: 7,1 cm | L: 7,1 cm | A: 2,19 cm

● Preto Art. n.º 1006577 21,00 EUR  
○ Branco 1006578 21,00 EUR



**Conector em L mecânico, p/ calha eletrificada saliente padrão, à esquerda (p/ instalação no teto)**  
Alumínio

C: 7,1 cm | L: 7,1 cm | A: 2,19 cm  
● Preto Art. n.º 1006575 21,00 EUR  
○ Branco 1006576 21,00 EUR



**Conector em L mecânico, p/ calha eletrificada saliente, padrão, Stereo, (parede/teto)**  
Alumínio  
C: 8,4 cm | L: 2,62 cm | A: 8,4 cm

● Preto Art. n.º 1006579 21,00 EUR  
○ Branco 1006580 21,00 EUR



**Conector em L elétrico, DALI**  
16 A máx. | Policarbonato (PC)  
C: 11,4 cm | L: 11,4 cm | A: 1,9 cm

● Preto Art. n.º 1006571 27,00 EUR  
○ Branco 1006572 27,00 EUR



**Conector longitudinal elétrico, DALI**  
16 A máx. | Policarbonato (PC)  
C: 14,4 cm | L: 1,6 cm | A: 1,9 cm

● Preto Art. n.º 1006569 21,00 EUR  
○ Branco 1006570 21,00 EUR



**Conector flexível, elétrico, DALI**  
16 A máx. | Policarbonato (PC)  
C: 23 cm | L: 1,6 cm | A: 1,9 cm

● Preto Art. n.º 1006573 29,00 EUR  
○ Branco 1006574 29,00 EUR



**Caixa de transformador incl. alimentador de extremidade à direita, DALI**  
Policarbonato (PC)  
C: 23,3 cm | L: 10,1 cm | A: 4,1 cm

● Preto Art. n.º 1007137 35,00 EUR  
○ Branco 1007138 35,00 EUR



**Caixa de transformador incl. alimentador de extremidade à esquerda, DALI**  
Policarbonato (PC)  
C: 23,3 cm | L: 10,1 cm | A: 4,1 cm

● Preto Art. n.º 1007083 35,00 EUR  
○ Branco 1007084 35,00 EUR



**Fonte de alimentação 48V | 60W**  
Policarbonato (PC)  
C: 18 cm | L: 4,5 cm | A: 2,7 cm

○ Branco Art. n.º 1006613 59,00 EUR



**Fonte de alimentação 150W | 48V**  
Metal/Policarbonato (PC)  
C: 19,05 cm | L: 8,8 cm | A: 3,55 cm

● Preto Art. n.º 1006614 129,00 EUR



**Cobertura, 20 mm p/ estrutura de calha padrão, 2 m**  
Alumínio /policarbonato (PC)  
C: 200 cm | L: 2 cm | A: 0,6 cm

● Preto Art. n.º 1006611 9,90 EUR  
○ Branco 1006612 9,90 EUR



**Tampa p/ calha eletrificada saliente padrão**  
Policarbonato (PC)  
C: 2,6 cm | L: 0,2 cm | A: 2,2 cm

● Preto Art. n.º 1006593 3,50 EUR  
○ Branco 1006594 3,50 EUR



**Placa de reforço de calhas p/ calha eletrificada saliente**  
Aço  
C: 5 cm | L: 1,32 cm | A: 0,25 cm

● Cinzento Art. n.º 1006609 8,80 EUR



**Placa de reforço de calhas com conjunto de suspensão, cabo de aço de 3 m**  
Aço  
C: 12 cm | L: 2,7 cm

● Preto Art. n.º 1006603 21,00 EUR  
○ Branco 1006604 21,00 EUR



**Placa de reforço de calhas com conjunto de suspensão, haste de 1 m**  
Aço  
C: 12 cm | L: 2,7 cm

● Preto Art. n.º 1006601 21,00 EUR  
○ Branco 1006602 21,00 EUR



**Estrutura suspensa, haste de 1 m**  
Aço  
L: 2,9 cm

● Preto Art. n.º 1006605 18,00 EUR  
○ Branco 1006606 18,00 EUR



**Estrutura suspensa, cabo de aço de 3 m**  
Aço  
L: 2,9 cm

● Preto Art. n.º 1006607 18,00 EUR  
○ Branco 1006608 18,00 EUR



**Grampo de fixação**  
Alumínio  
C: 3 cm | L: 2,72 cm | A: 1,05 cm

● Preto Art. n.º 1006599 7,50 EUR  
○ Branco 1006600 7,50 EUR



**Intrack controlador LED (driver) 48VDC | 250 W, incl. DALI por cabo**  
Policarbonato (PC)  
C: 26,8 cm | L: 2,2 cm | A: 4,35 cm

● Preto Art. n.º 1007872 139,00 EUR  
○ Branco 1007873 139,00 EUR



**Intrack controlador LED (driver) 48VDC | 100 W, incl. DALI por cabo**  
Policarbonato (PC)  
C: 29,75 cm | L: 1,6 cm | A: 1,9 cm

● Preto Art. n.º 1007870 109,00 EUR  
○ Branco 1007871 109,00 EUR

1006726 + 1006623 + 1006617 517 + 525 + 523





## 48V TRACK

Calha eletrificada saliente em profundidade DALI



	1 m	1 m	2 m	2 m
Tensão nominal (V)	48V DC	48V DC	48V DC	48V DC
Intensidade máx. de corrente (A)	16	16	16	16
Carga mec. máx.	5 kg	5 kg	10 kg	10 kg
Cor	● Preto	○ Branco	● Preto	○ Branco
Material	Alumínio	Alumínio	Alumínio	Alumínio
C x L x A (cm)	100 x 2,62 x 4,72	100 x 2,62 x 4,72	200 x 2,62 x 4,72	200 x 2,62 x 4,72
Art. n.º	1006549	1006550	1006551	1006552
EUR	59,00	59,00	115,00	115,00

	3 m	3 m	4 m	4 m
Tensão nominal (V)	48V DC	48V DC	48V DC	48V DC
Intensidade máx. de corrente (A)	16	16	16	16
Carga mec. máx.	15 kg	15.29 kg	20 kg	20 kg
Cor	● Preto	○ Branco	● Preto	○ Branco
Material	Alumínio	Alumínio	Alumínio	Alumínio
C x L x A (cm)	300 x 2,62 x 4,72	300 x 2,62 x 4,72	400 x 2,62 x 4,72	400 x 2,62 x 4,72
Art. n.º	1006553	1006554	1006555	1006556
EUR	170,00	170,00	228,00	228,00

# 48V TRACK

Calha eletrificada saliente em profundidade DALI  
 Guia de planeamento e visão geral de acessórios

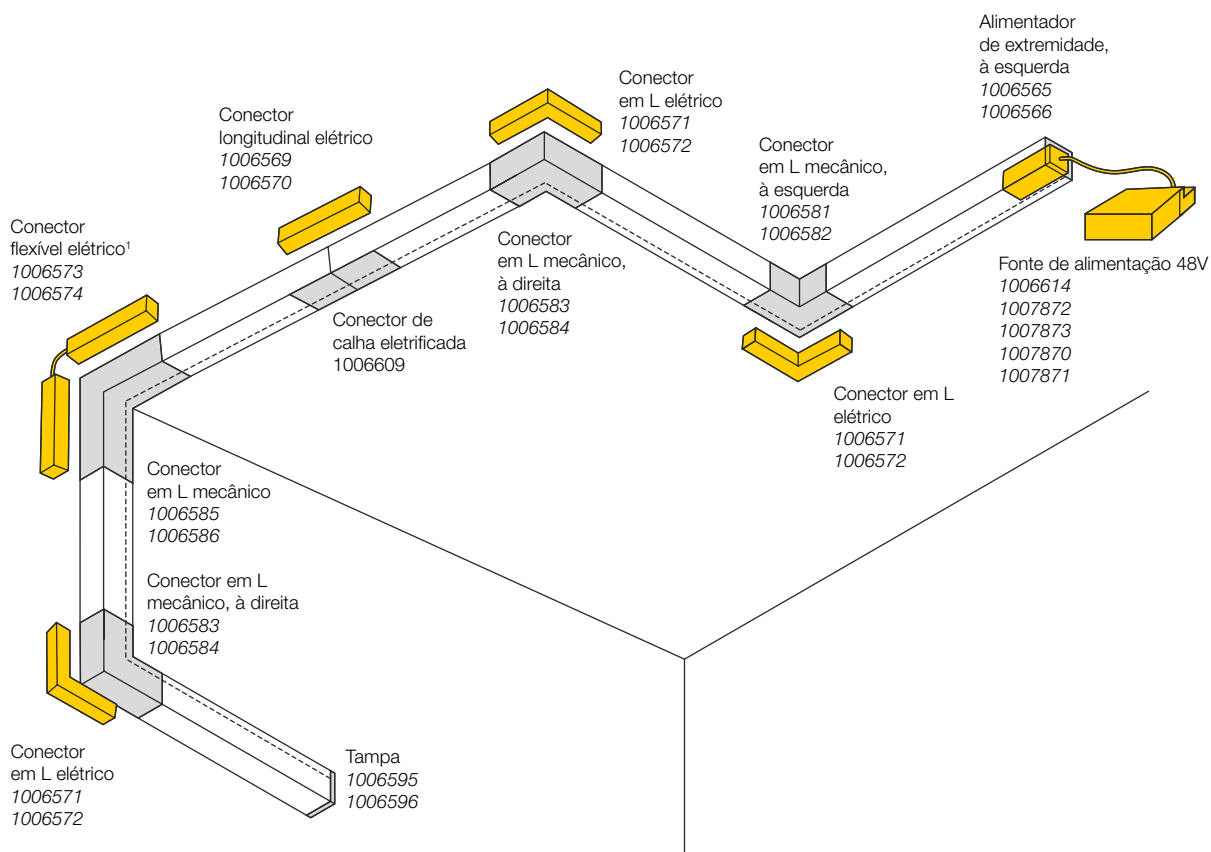

<sup>1</sup> Tenha em atenção que conectores elétricos e mecânicos têm de ser sempre instalados juntos.

## Alimentador de extremidade, à esquerda

16 A máx. | Policarbonato (PC)  
 C: 9,7 cm | L: 1,6 cm | A: 1,9 cm



- Preto
- Branco

Art. n.º **1006565** 14,00 EUR  
**1006566** 14,00 EUR

## Alimentador de extremidade, à direita

16 A máx. | Policarbonato (PC)  
 C: 9,7 cm | L: 1,6 cm | A: 1,9 cm



- Preto
- Branco

Art. n.º **1006567** 14,00 EUR  
**1006568** 14,00 EUR



**Conector em L mecânico, p/ calha eletrificada saliente em profundidade, à esquerda (p/ instalação no teto)**

Alumínio  
C: 7,1 cm | L: 7,1 cm | A: 4,7 cm  
● Preto Art. n.º 1006581 29,00 EUR  
○ Branco 1006582 29,00 EUR



**Conector em L mecânico, p/ calha eletrificada saliente em profundidade, à direita (p/ instalação no teto)**

Alumínio  
C: 7,1 cm | L: 7,1 cm | A: 4,7 cm  
● Preto Art. n.º 1006583 29,00 EUR  
○ Branco 1006584 29,00 EUR



**Conector em L mecânico, p/ calha eletrificada saliente, em profundidade, Stereo (parede/teto)**

Alumínio  
C: 8,4 cm | L: 8,4 cm | A: 4,7 cm  
● Preto Art. n.º 1006585 29,00 EUR  
○ Branco 1006586 29,00 EUR



**Conector em L elétrico, DALI**

16 A máx. | Policarbonato (PC)  
C: 11,4 cm | L: 11,4 cm | A: 1,9 cm  
● Preto Art. n.º 1006571 27,00 EUR  
○ Branco 1006572 27,00 EUR



**Conector longitudinal elétrico, DALI**

16 A máx. | Policarbonato (PC)  
C: 14,4 cm | L: 1,6 cm | A: 1,9 cm  
● Preto Art. n.º 1006569 21,00 EUR  
○ Branco 1006570 21,00 EUR



**Conector flexível, elétrico, DALI**

16 A máx. | Policarbonato (PC)  
C: 23 cm | L: 1,6 cm | A: 1,9 cm  
● Preto Art. n.º 1006573 29,00 EUR  
○ Branco 1006574 29,00 EUR



**Caixa de transformador incl. alimentador de extremidade à esquerda, DALI**

Policarbonato (PC)  
C: 23,3 cm | L: 10,1 cm | A: 4,1 cm  
● Preto Art. n.º 1007083 35,00 EUR  
○ Branco 1007084 35,00 EUR



**Caixa de transformador incl. alimentador de extremidade à direita, DALI**

Policarbonato (PC)  
C: 23,3 cm | L: 10,1 cm | A: 4,1 cm  
● Preto Art. n.º 1007137 35,00 EUR  
○ Branco 1007138 35,00 EUR



**Fonte de alimentação 48V | 60W**

Policarbonato (PC)  
C: 18 cm | L: 4,5 cm | A: 2,7 cm  
○ Branco Art. n.º 1006613 59,00 EUR



**Fonte de alimentação 150W | 48V**

Metal/Policarbonato (PC)  
C: 19,05 cm | L: 8,8 cm | A: 3,55 cm  
● Preto Art. n.º 1006614 129,00 EUR



**Tampa de calha, 26 mm, p/ calha eletrificada saliente em profundidade e calha eletrificada de montagem encastrada, 2 m**

Policarbonato (PC)  
C: 200 cm | L: 26 cm | A: 6 cm  
● Preto Art. n.º 1007188 12,00 EUR  
○ Branco 1007189 12,00 EUR



**Tampa p/ calha eletrificada saliente em profundidade**

Policarbonato (PC)  
C: 2,6 cm | L: 0,2 cm | A: 4,7 cm  
● Preto Art. n.º 1006595 6,50 EUR  
○ Branco 1006596 6,50 EUR



**Placa de reforço de calhas p/ calha eletrificada saliente**

Aço  
C: 5 cm | L: 1,32 cm | A: 0,25 cm  
● Cinzento Art. n.º 1006609 8,80 EUR



**Placa de reforço de calhas com conjunto de suspensão, cabo de aço de 3 m**

Aço  
C: 12 cm | L: 2,7 cm  
● Preto Art. n.º 1006603 21,00 EUR  
○ Branco 1006604 21,00 EUR



**Placa de reforço de calhas com conjunto de suspensão, haste de 1 m**

Aço  
C: 12 cm | L: 2,7 cm  
● Preto Art. n.º 1006601 21,00 EUR  
○ Branco 1006602 21,00 EUR



**Estrutura suspensa, haste de 1 m**

Aço  
L: 2,9 cm  
● Preto Art. n.º 1006605 18,00 EUR  
○ Branco 1006606 18,00 EUR



**Estrutura suspensa, cabo de aço de 3 m**

Aço  
L: 2,9 cm  
● Preto Art. n.º 1006607 18,00 EUR  
○ Branco 1006608 18,00 EUR



**Grampo de fixação**

Alumínio  
C: 3 cm | L: 2,72 cm | A: 1,05 cm  
● Preto Art. n.º 1006599 7,50 EUR  
○ Branco 1006600 7,50 EUR



**Intrack controlador LED (driver) 48VDC | 250 W, incl. DALI por cabo**

Policarbonato (PC)  
C: 26,8 cm | L: 2,2 cm | A: 4,35 cm  
● Preto Art. n.º 1007872 139,00 EUR  
○ Branco 1007873 139,00 EUR



**Intrack controlador LED (driver) 48VDC | 100 W, incl. DALI por cabo**

Policarbonato (PC)  
C: 29,75 cm | L: 1,6 cm | A: 1,9 cm  
● Preto Art. n.º 1007870 109,00 EUR  
○ Branco 1007871 109,00 EUR

1006783 + 1006672 + 1006635 519 + 515 + 525





## 48V TRACK

Calha eletrificada de montagem encastrada DALI



	1 m	1 m	2 m	2 m
Tensão nominal (V)	48V DC	48V DC	48V DC	48V DC
Intensidade máx. de corrente (A)	16	16	16	16
Carga mec. máx.	5.09 kg	5 kg	10 kg	10 kg
Cor	● Preto	○ Branco	● Preto	○ Branco
Material	Alumínio	Alumínio	Alumínio	Alumínio
C x L x A (cm)	100 x 7,4 x 4,7	100 x 7,4 x 4,7	200 x 7,4 x 4,7	200 x 7,4 x 4,7
Art. n.º	1006557	1006558	1006559	1006560
EUR	79,00	79,00	138,00	138,00

	3 m	3 m	4 m	4 m
Tensão nominal (V)	48V DC	48V DC	48V DC	48V DC
Intensidade máx. de corrente (A)	16	16	16	16
Carga mec. máx.	15 kg	15 kg	20.38 kg	20 kg
Cor	● Preto	○ Branco	● Preto	○ Branco
Material	Alumínio	Alumínio	Alumínio	Alumínio
C x L x A (cm)	300 x 7,4 x 4,7	300 x 7,4 x 4,7	400 x 7,4 x 4,7	400 x 7,4 x 4,7
Art. n.º	1006561	1006562	1006563	1006564
EUR	178,00	178,00	256,00	256,00

# 48V TRACK

Calha eletrificada de montagem encastrada DALI  
 Guia de planeamento e visão geral de acessórios

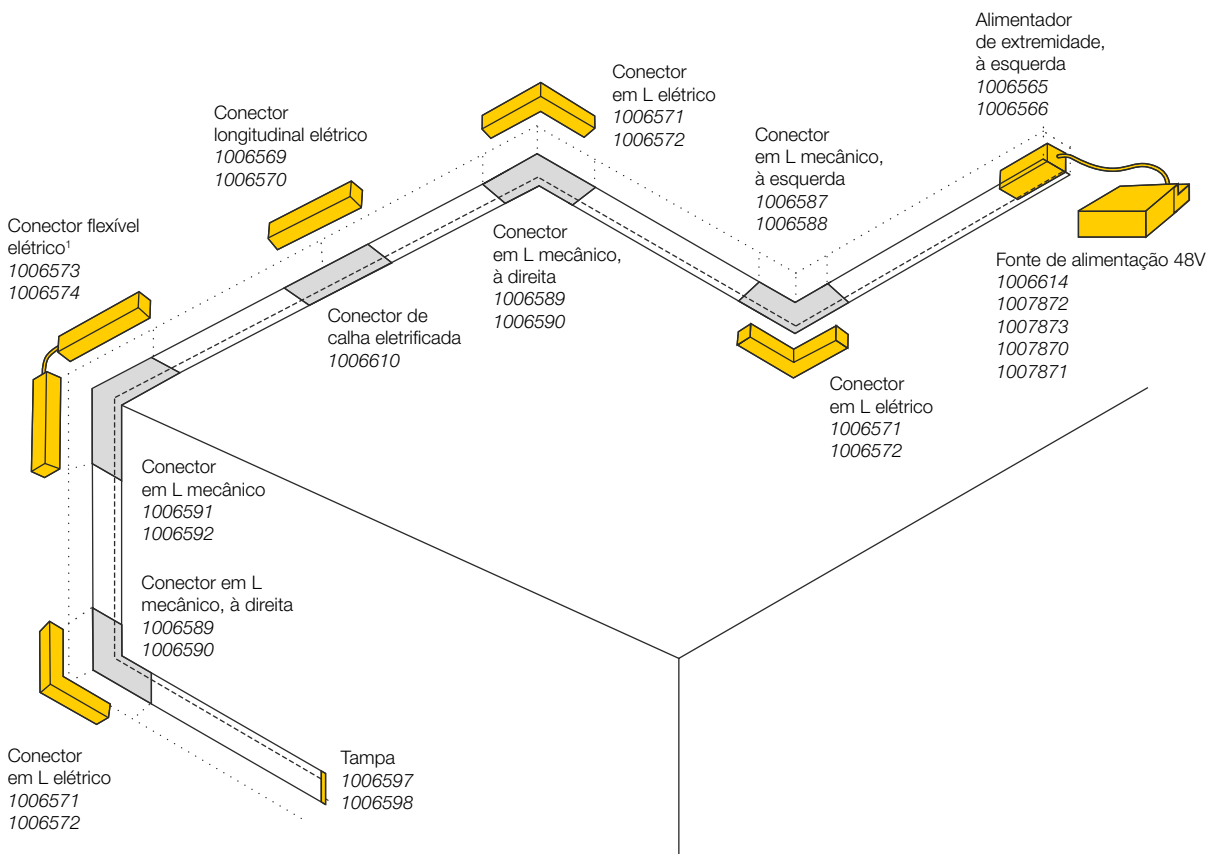

<sup>1</sup> Tenha em atenção que conectores elétricos e mecânicos têm de ser sempre instalados juntos.

## Alimentador de extremidade, à esquerda

16 A máx. | Policarbonato (PC)  
 C: 9,7 cm | L: 1,6 cm | A: 1,9 cm



- Preto
- Branco

Art. n.º **1006565** **14,00 EUR**  
**1006566** **14,00 EUR**

## Alimentador de extremidade, à direita

16 A máx. | Policarbonato (PC)  
 C: 9,7 cm | L: 1,6 cm | A: 1,9 cm



- Preto
- Branco

Art. n.º **1006567** **14,00 EUR**  
**1006568** **14,00 EUR**





**Conector em L mecânico, p/ calha eletrificada de montagem encastrada, em profundidade, à esquerda (p/ instalação no teto)**

Alumínio  
C: 9,5 cm | L: 9,5 cm | A: 4,69 cm  
● Preto Art. n.º 1006587 32,00 EUR  
○ Branco 1006588 32,00 EUR



**Conector em L mecânico, p/ calha eletrificada de montagem encastrada, em profundidade, à direita (p/ instalação no teto)**

Alumínio  
C: 9,5 cm | L: 9,5 cm | A: 4,69 cm  
● Preto Art. n.º 1006589 32,00 EUR  
○ Branco 1006590 32,00 EUR



**Conector em L mecânico, p/ calha eletrificada de montagem encastrada, em profundidade, Stereo, (parede/teto)**

Alumínio  
C: 8,1 cm | L: 7,4 cm | A: 8,1 cm  
● Preto Art. n.º 1006591 32,00 EUR  
○ Branco 1006592 32,00 EUR



**Conector em L elétrico, DALI**  
16 A máx. | Policarbonato (PC)  
C: 11,4 cm | L: 11,4 cm | A: 1,9 cm

● Preto Art. n.º 1006571 27,00 EUR  
○ Branco 1006572 27,00 EUR



**Conector longitudinal elétrico, DALI**  
16 A máx. | Policarbonato (PC)  
C: 14,4 cm | L: 1,6 cm | A: 1,9 cm

● Preto Art. n.º 1006569 21,00 EUR  
○ Branco 1006570 21,00 EUR



**Conector flexível, elétrico, DALI**  
16 A máx. | Policarbonato (PC)  
C: 23 cm | L: 1,6 cm | A: 1,9 cm

● Preto Art. n.º 1006573 29,00 EUR  
○ Branco 1006574 29,00 EUR



**Caixa de transformador incl. alimentador de extremidade à esquerda, DALI**  
Policarbonato (PC)  
C: 23,3 cm | L: 10,1 cm | A: 4,1 cm

● Preto Art. n.º 1007083 35,00 EUR  
○ Branco 1007084 35,00 EUR



**Caixa de transformador incl. alimentador de extremidade à direita, DALI**  
Policarbonato (PC)  
C: 23,3 cm | L: 10,1 cm | A: 4,1 cm

● Preto Art. n.º 1007137 35,00 EUR  
○ Branco 1007138 35,00 EUR



**Fonte de alimentação 48V | 60W**  
Policarbonato (PC)  
C: 18 cm | L: 4,5 cm | A: 2,7 cm

○ Branco Art. n.º 1006613 59,00 EUR



**Fonte de alimentação 150W | 48V**  
Metal/Policarbonato (PC)  
C: 19,05 cm | L: 8,8 cm | A: 3,55 cm

● Preto Art. n.º 1006614 129,00 EUR



**Tampa de calha, 26 mm, p/ calha eletrificada saliente em profundidade e calha eletrificada de montagem encastrada, 2 m**  
Policarbonato (PC)  
C: 200 cm | L: 26 cm | A: 6 cm

● Preto Art. n.º 1007188 12,00 EUR  
○ Branco 1007189 12,00 EUR

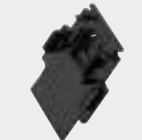

**Tampa p/ calha eletrificada de montagem encastrada**  
Policarbonato (PC)  
C: 3,4 cm | L: 0,2 cm | A: 4,7 cm

● Preto Art. n.º 1006597 3,50 EUR  
○ Branco 1006598 3,50 EUR

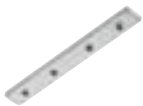

**Conj. placas de reforço de calhas p/ calha eletrificada de montagem encastrada**  
Aço  
C: 6,3 cm | L: 0,76 cm | A: 0,25 cm

● Cinzento Art. n.º 1006610 8,80 EUR



**Placa de reforço de calhas com conjunto de suspensão, cabo de aço de 3 m**  
Aço  
C: 12 cm | L: 2,7 cm

● Preto Art. n.º 1006603 21,00 EUR  
○ Branco 1006604 21,00 EUR



**Placa de reforço de calhas com conjunto de suspensão, haste de 1 m**  
Aço  
C: 12 cm | L: 2,7 cm

● Preto Art. n.º 1006601 21,00 EUR  
○ Branco 1006602 21,00 EUR



**Estrutura suspensa, haste de 1 m**  
Aço  
L: 2,9 cm

● Preto Art. n.º 1006605 18,00 EUR  
○ Branco 1006606 18,00 EUR



**Estrutura suspensa, cabo de aço de 3 m**  
Aço  
L: 2,9 cm

● Preto Art. n.º 1006607 18,00 EUR  
○ Branco 1006608 18,00 EUR



**Grampo de fixação**  
Alumínio  
C: 3 cm | L: 2,72 cm | A: 1,05 cm

● Preto Art. n.º 1006599 7,50 EUR  
○ Branco 1006600 7,50 EUR



**Intrack controlador LED (driver) 48VDC | 250 W, incl. DALI por cabo**  
Policarbonato (PC)  
C: 26,8 cm | L: 2,2 cm | A: 4,35 cm

● Preto Art. n.º 1007872 139,00 EUR  
○ Branco 1007873 139,00 EUR



**Intrack controlador LED (driver) 48VDC | 100 W, incl. DALI por cabo**  
Policarbonato (PC)  
C: 29,75 cm | L: 1,6 cm | A: 1,9 cm

● Preto Art. n.º 1007870 109,00 EUR  
○ Branco 1007871 109,00 EUR

NUMINOS® XS  
48V, DALI

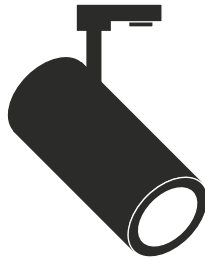

● Preto

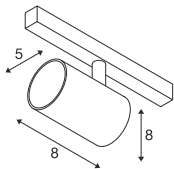

48V  
200mA  
Potência do sistema: 8,7W  
Material: alumínio/policarbonato (PC)

Versão	EUR
Versões XS	175,00

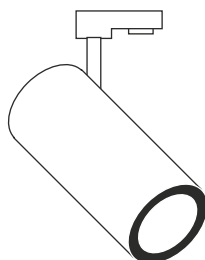

○ Branco



● Versões Preto

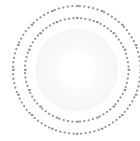

○ Branco

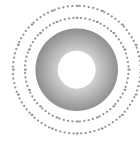

● Cromado



● Preto



○ Branco

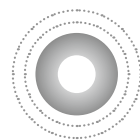

● Cromado



				UGR	Art. N.º	
	2700K	640lm	20°	16	<b>1006651</b>	
		620lm	40°	22	<b>1006654</b>	
		640lm	55°	25	<b>1006657</b>	
	3000K	700lm	20°	16	<b>1006669</b>	
		670lm	40°	22	<b>1006672</b>	
		690lm	55°	25	<b>1006675</b>	
	4000K	720lm	20°	16	<b>1006687</b>	
		700lm	40°	22	<b>1006690</b>	
		710lm	55°	25	<b>1006693</b>	
	2700K	670lm	20°	16	<b>1006652</b>	
		650lm	40°	22	<b>1006655</b>	
		670lm	55°	25	<b>1006658</b>	
	3000K	730lm	20°	16	<b>1006670</b>	
		700lm	40°	22	<b>1006673</b>	
		720lm	55°	25	<b>1006676</b>	
	4000K	750lm	20°	16	<b>1006688</b>	
		730lm	40°	22	<b>1006691</b>	
		740lm	55°	25	<b>1006694</b>	
	2700K	670lm	20°	16	<b>1006653</b>	
		650lm	40°	22	<b>1006656</b>	
		670lm	55°	25	<b>1006659</b>	
	3000K	730lm	20°	16	<b>1006671</b>	
		700lm	40°	22	<b>1006674</b>	
		720lm	55°	25	<b>1006677</b>	
	4000K	750lm	20°	16	<b>1006689</b>	
		730lm	40°	22	<b>1006692</b>	
		740lm	55°	25	<b>1006695</b>	
	2700K	640lm	20°	16	<b>1006660</b>	
		620lm	40°	22	<b>1006663</b>	
		640lm	55°	25	<b>1006666</b>	
	3000K	700lm	20°	16	<b>1006678</b>	
		670lm	40°	22	<b>1006681</b>	
		690lm	55°	25	<b>1006684</b>	
	4000K	720lm	20°	16	<b>1006696</b>	
		700lm	40°	22	<b>1006699</b>	
		710lm	55°	25	<b>1006702</b>	
	2700K	670lm	20°	16	<b>1006661</b>	
		650lm	40°	22	<b>1006664</b>	
		670lm	55°	25	<b>1006667</b>	
	3000K	730lm	20°	16	<b>1006679</b>	
		700lm	40°	22	<b>1006682</b>	
		720lm	55°	25	<b>1006685</b>	
	4000K	750lm	20°	16	<b>1006697</b>	
		730lm	40°	22	<b>1006700</b>	
		740lm	55°	25	<b>1006703</b>	
	2700K	670lm	20°	16	<b>1006662</b>	
		650lm	40°	22	<b>1006665</b>	
		670lm	55°	25	<b>1006668</b>	
	3000K	730lm	20°	16	<b>1006680</b>	
		700lm	40°	22	<b>1006683</b>	
		720lm	55°	25	<b>1006686</b>	
	4000K	750lm	20°	16	<b>1006698</b>	
		730lm	40°	22	<b>1006701</b>	
		740lm	55°	25	<b>1006704</b>	

NUMINOS® S  
48V, DALI

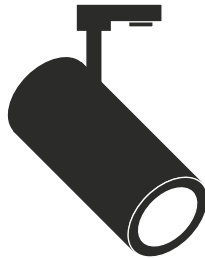

● Preto

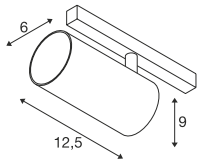

48V  
250mA  
Potência do sistema: 16W  
Material: alumínio/policarbonato (PC)

Versão	EUR
Versões S	185,00



● Preto



○ Branco

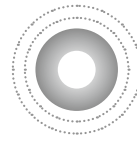

● Cromado



● Preto



○ Branco

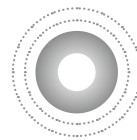



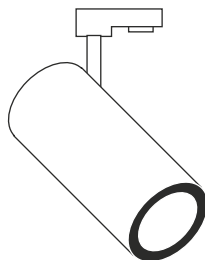











● Cromado



○ Branco



				UGR	Art. N.º	
	2700K	1000lm	20°	19	<b>1006705</b>	
		970lm	40°	16	<b>1006708</b>	
		960lm	55°	19	<b>1006711</b>	
	3000K	1060lm	20°	19	<b>1006723</b>	
		1030lm	40°	19	<b>1006726</b>	
		1030lm	55°	22	<b>1006729</b>	
	4000K	1280lm	20°	22	<b>1006741</b>	
		1150lm	40°	19	<b>1006744</b>	
		1130lm	55°	19	<b>1006747</b>	
	2700K	1020lm	20°	19	<b>1006706</b>	
		1050lm	40°	19	<b>1006709</b>	
		1030lm	55°	22	<b>1006712</b>	
	3000K	1120lm	20°	19	<b>1006724</b>	
		1120lm	40°	19	<b>1006727</b>	
		1120lm	55°	22	<b>1006730</b>	
	4000K	1350lm	20°	22	<b>1006742</b>	
		1230lm	40°	19	<b>1006745</b>	
		1220lm	55°	22	<b>1006748</b>	
	2700K	960lm	20°	19	<b>1006707</b>	
		1000lm	40°	16	<b>1006710</b>	
		980lm	55°	19	<b>1006713</b>	
	3000K	1050lm	20°	19	<b>1006725</b>	
		1050lm	40°	19	<b>1006728</b>	
		1050lm	55°	22	<b>1006731</b>	
	4000K	1350lm	20°	22	<b>1006743</b>	
		1200lm	40°	19	<b>1006746</b>	
		1170lm	55°	22	<b>1006749</b>	
	2700K	1000lm	20°	19	<b>1006714</b>	
		970lm	40°	16	<b>1006717</b>	
		960lm	55°	19	<b>1006720</b>	
	3000K	1060lm	20°	19	<b>1006732</b>	
		1030lm	40°	19	<b>1006735</b>	
		1030lm	55°	22	<b>1006738</b>	
	4000K	1280lm	20°	22	<b>1006750</b>	
		1150lm	40°	19	<b>1006753</b>	
		1130lm	55°	19	<b>1006756</b>	
	2700K	1020lm	20°	19	<b>1006715</b>	
		1050lm	40°	19	<b>1006718</b>	
		1030lm	55°	22	<b>1006721</b>	
	3000K	1120lm	20°	19	<b>1006733</b>	
		1120lm	40°	19	<b>1006736</b>	
		1120lm	55°	22	<b>1006739</b>	
	4000K	1350lm	20°	22	<b>1006751</b>	
		1230lm	40°	19	<b>1006754</b>	
		1220lm	55°	22	<b>1006757</b>	
	2700K	960lm	20°	19	<b>1006716</b>	
		1000lm	40°	16	<b>1006719</b>	
		980lm	55°	19	<b>1006722</b>	
	3000K	1050lm	20°	19	<b>1006734</b>	
		1050lm	40°	19	<b>1006737</b>	
		1050lm	55°	22	<b>1006740</b>	
	4000K	1350lm	20°	22	<b>1006752</b>	
		1200lm	40°	19	<b>1006755</b>	
		1170lm	55°	22	<b>1006758</b>	

NUMINOS® XS  
48V, DALI

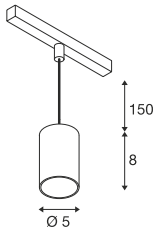

48V  
200mA  
Potência do sistema: 8,7W  
Material: alumínio/policarbonato (PC)

Versão	EUR
Versões XS	195,00

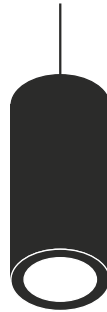

● Preto

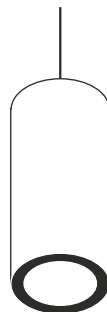

○ Branco



● Preto

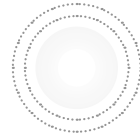

○ Branco

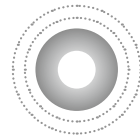

● Cromado



● Preto



○ Branco

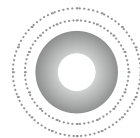

● Cromado



				UGR	Art. N.º	
	2700K	640lm	20°	16	<b>1006759</b>	
		620lm	40°	22	<b>1006762</b>	
		640lm	55°	25	<b>1006765</b>	
	3000K	700lm	20°	16	<b>1006777</b>	
		670lm	40°	22	<b>1006780</b>	
		690lm	55°	25	<b>1006783</b>	
	4000K	720lm	20°	16	<b>1006795</b>	
		700lm	40°	22	<b>1006798</b>	
		710lm	55°	25	<b>1006801</b>	
	2700K	670lm	20°	16	<b>1006760</b>	
		650lm	40°	22	<b>1006763</b>	
		670lm	55°	25	<b>1006766</b>	
	3000K	730lm	20°	16	<b>1006778</b>	
		700lm	40°	22	<b>1006781</b>	
		720lm	55°	25	<b>1006784</b>	
	4000K	750lm	20°	16	<b>1006796</b>	
		730lm	40°	22	<b>1006799</b>	
		740lm	55°	25	<b>1006802</b>	
	2700K	670lm	20°	16	<b>1006761</b>	
		650lm	40°	22	<b>1006764</b>	
		670lm	55°	25	<b>1006767</b>	
	3000K	730lm	20°	16	<b>1006779</b>	
		700lm	40°	22	<b>1006782</b>	
		720lm	55°	25	<b>1006785</b>	
	4000K	750lm	20°	16	<b>1006797</b>	
		730lm	40°	22	<b>1006800</b>	
		740lm	55°	25	<b>1006803</b>	
	2700K	640lm	20°	16	<b>1006768</b>	
		620lm	40°	22	<b>1006771</b>	
		640lm	55°	25	<b>1006774</b>	
	3000K	700lm	20°	16	<b>1006786</b>	
		670lm	40°	22	<b>1006789</b>	
		690lm	55°	25	<b>1006792</b>	
	4000K	720lm	20°	16	<b>1006804</b>	
		700lm	40°	22	<b>1006807</b>	
		710lm	55°	25	<b>1006810</b>	
	2700K	670lm	20°	16	<b>1006769</b>	
		650lm	40°	22	<b>1006772</b>	
		670lm	55°	25	<b>1006775</b>	
	3000K	730lm	20°	16	<b>1006787</b>	
		700lm	40°	22	<b>1006790</b>	
		720lm	55°	25	<b>1006793</b>	
	4000K	750lm	20°	16	<b>1006805</b>	
		730lm	40°	22	<b>1006808</b>	
		740lm	55°	25	<b>1006811</b>	
	2700K	670lm	20°	16	<b>1006770</b>	
		650lm	40°	22	<b>1006773</b>	
		670lm	55°	25	<b>1006776</b>	
	3000K	730lm	20°	16	<b>1006788</b>	
		700lm	40°	22	<b>1006791</b>	
		720lm	55°	25	<b>1006794</b>	
	4000K	750lm	20°	16	<b>1006806</b>	
		730lm	40°	22	<b>1006809</b>	
		740lm	55°	25	<b>1006812</b>	

NUMINOS® S  
48V, DALI

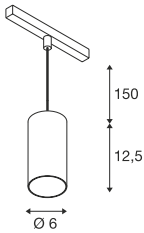

48V  
250mA  
Potência do sistema: 16W  
Material: alumínio/policarbonato (PC)

Versão	EUR
Versões S	205,00



● Preto

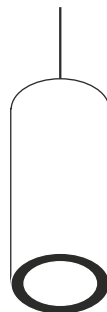

○ Branco



● Preto

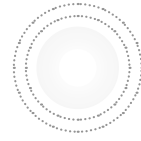

○ Branco

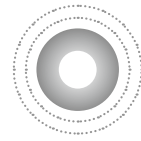

● Cromado



● Preto

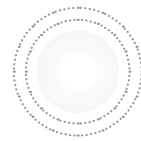

○ Branco

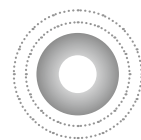

● Cromado





				UGR	Art. N.º	
	2700K	1000lm	20°	19	<b>1006813</b>	
		970lm	40°	16	<b>1006816</b>	
		960lm	55°	19	<b>1006819</b>	
	3000K	1060lm	20°	19	<b>1006831</b>	
		1030lm	40°	19	<b>1006834</b>	
		1030lm	55°	22	<b>1006837</b>	
	4000K	1280lm	20°	22	<b>1006849</b>	
		1150lm	40°	19	<b>1006852</b>	
		1130lm	55°	19	<b>1006855</b>	
	2700K	1020lm	20°	19	<b>1006814</b>	
		1050lm	40°	19	<b>1006817</b>	
		1030lm	55°	22	<b>1006820</b>	
	3000K	1120lm	20°	19	<b>1006832</b>	
		1120lm	40°	19	<b>1006835</b>	
		1120lm	55°	22	<b>1006838</b>	
	4000K	1350lm	20°	22	<b>1006850</b>	
		1230lm	40°	19	<b>1006853</b>	
		1220lm	55°	22	<b>1006856</b>	
	2700K	960lm	20°	19	<b>1006815</b>	
		1000lm	40°	16	<b>1006818</b>	
		980lm	55°	19	<b>1006821</b>	
	3000K	1050lm	20°	19	<b>1006833</b>	
		1050lm	40°	19	<b>1006836</b>	
		1050lm	55°	22	<b>1006839</b>	
	4000K	1350lm	20°	22	<b>1006851</b>	
		1200lm	40°	19	<b>1006854</b>	
		1170lm	55°	22	<b>1006857</b>	
	2700K	1000lm	20°	19	<b>1006822</b>	
		970lm	40°	16	<b>1006825</b>	
		960lm	55°	19	<b>1006828</b>	
	3000K	1060lm	20°	19	<b>1006840</b>	
		1030lm	40°	19	<b>1006843</b>	
		1030lm	55°	22	<b>1006846</b>	
	4000K	1280lm	20°	22	<b>1006858</b>	
		1150lm	40°	19	<b>1006861</b>	
		1130lm	55°	19	<b>1006864</b>	
	2700K	1020lm	20°	19	<b>1006823</b>	
		1050lm	40°	19	<b>1006826</b>	
		1030lm	55°	22	<b>1006829</b>	
	3000K	1120lm	20°	19	<b>1006841</b>	
		1120lm	40°	19	<b>1006844</b>	
		1120lm	55°	22	<b>1006847</b>	
	4000K	1350lm	20°	22	<b>1006859</b>	
		1230lm	40°	19	<b>1006862</b>	
		1220lm	55°	22	<b>1006865</b>	
	2700K	960lm	20°	19	<b>1006824</b>	
		1000lm	40°	16	<b>1006827</b>	
		980lm	55°	19	<b>1006830</b>	
	3000K	1050lm	20°	19	<b>1006842</b>	
		1050lm	40°	19	<b>1006845</b>	
		1050lm	55°	22	<b>1006848</b>	
	4000K	1350lm	20°	22	<b>1006860</b>	
		1200lm	40°	19	<b>1006863</b>	
		1170lm	55°	22	<b>1006866</b>	

1006654 + 1006633 + 1006627 515 + 525 + 523

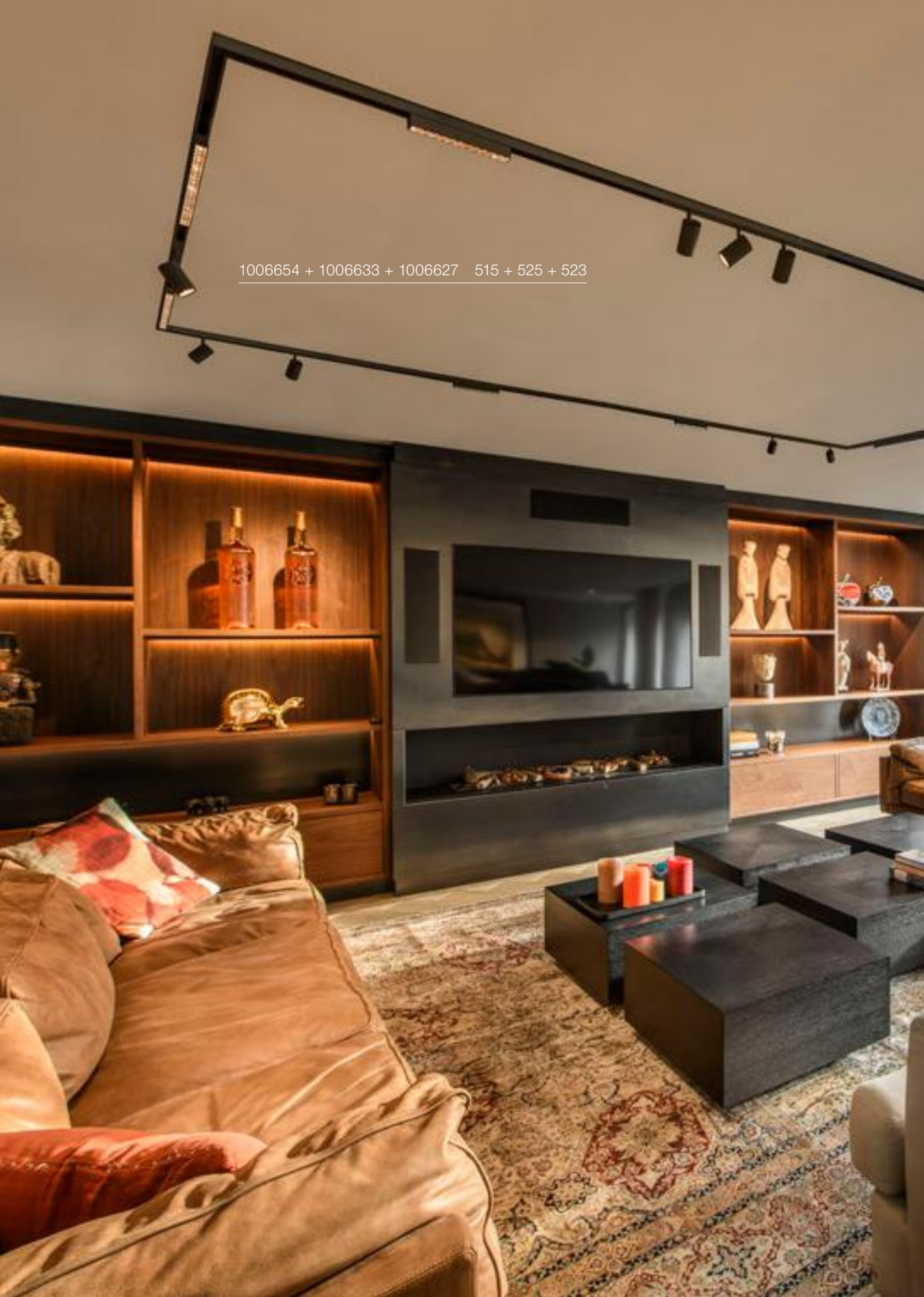



### IN-LINE 22 48V, opal, DALI

### IN-LINE 22 48V, Darklight Reflector, DALI

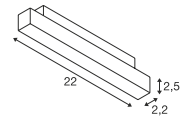
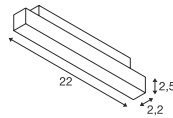

48V | 350mA  
Potência do sistema: 7,3W  
Material: alumínio

48V | 350mA  
Potência do sistema: 7,3W  
Material: alumínio/policarbonato (PC)



Down	540lm	2700K
	570lm	3000K
	680lm	4000K

Down	580lm	2700K
	610lm	3000K
	650lm	4000K

Versão	Art. n.º	EUR
● Preto 540lm   2700K	1006615	125,00
● Preto 570lm   3000K	1006617	125,00
● Preto 680lm   4000K	1006619	125,00
○ Branco 540lm   2700K	1006616	125,00
○ Branco 570lm   3000K	1006618	125,00
○ Branco 680lm   4000K	1006620	125,00

Versão	Art. n.º	EUR
● Preto 580lm   2700K	1006627	140,00
● Preto 610lm   3000K	1006629	140,00
● Preto 650lm   4000K	1006631	140,00
○ Branco 580lm   2700K	1006628	140,00
○ Branco 610lm   3000K	1006630	140,00
○ Branco 650lm   4000K	1006632	140,00

1006633 + 1006654 525 + 515





### IN-LINE 44 48V, opal, DALI

### IN-LINE 44 48V, Darklight Reflector, DALI

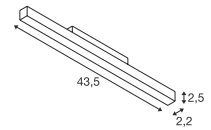
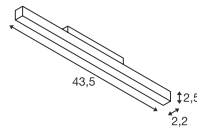
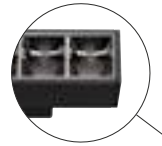
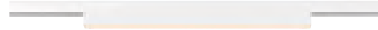

48V | 350mA  
Potência do sistema: 14W  
Material: alumínio

48V | 350mA  
Potência do sistema: 14W  
Material: alumínio/policarbonato (PC)



Down	1140lm	2700K
	1180lm	3000K
	1450lm	4000K

Down	1180lm	2700K
	1230lm	3000K
	1250lm	4000K

Versão	Art. n.º	EUR
● Preto 1140lm   2700K	<b>1006621</b>	<b>184,00</b>
● Preto 1180lm   3000K	<b>1006623</b>	<b>184,00</b>
● Preto 1450lm   4000K	<b>1006625</b>	<b>184,00</b>
○ Branco 1140lm   2700K	<b>1006622</b>	<b>184,00</b>
○ Branco 1180lm   3000K	<b>1006624</b>	<b>184,00</b>
○ Branco 1450lm   4000K	<b>1006626</b>	<b>184,00</b>

Versão	Art. n.º	EUR
● Preto 1180lm   2700K	<b>1006633</b>	<b>199,00</b>
● Preto 1230lm   3000K	<b>1006635</b>	<b>199,00</b>
● Preto 1250lm   4000K	<b>1006637</b>	<b>199,00</b>
○ Branco 1180lm   2700K	<b>1006634</b>	<b>199,00</b>
○ Branco 1230lm   3000K	<b>1006636</b>	<b>199,00</b>
○ Branco 1250lm   4000K	<b>1006638</b>	<b>199,00</b>

1006682 + 1006648 515 + 527





**IN-LINE 24**  
48V, Move, Darklight Reflector, DALI

**IN-LINE 46**  
48V, Move, Darklight Reflector, DALI

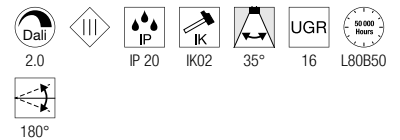
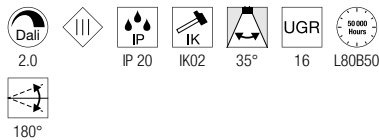
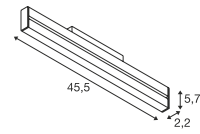
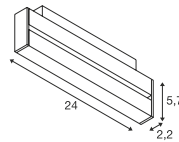

48V | 350mA  
Potência do sistema: 7,3W  
Material: alumínio/polycarbonato (PC)

48V | 350mA  
Potência do sistema: 14W  
Material: alumínio/polycarbonato (PC)



Down	580lm	2700K
	610lm	3000K
	650lm	4000K

Down	1180lm	2700K
	1230lm	3000K
	1250lm	4000K

Versão	Art. n.º	EUR
● Preto 580lm   2700K	<b>1006639</b>	<b>150,00</b>
● Preto 610lm   3000K	<b>1006641</b>	<b>150,00</b>
● Preto 650lm   4000K	<b>1006643</b>	<b>150,00</b>
○ Branco 580lm   2700K	<b>1006640</b>	<b>150,00</b>
○ Branco 610lm   3000K	<b>1006642</b>	<b>150,00</b>
○ Branco 650lm   4000K	<b>1006644</b>	<b>150,00</b>

Versão	Art. n.º	EUR
● Preto 1180lm   2700K	<b>1006645</b>	<b>209,00</b>
● Preto 1230lm   3000K	<b>1006647</b>	<b>209,00</b>
● Preto 1250lm   4000K	<b>1006649</b>	<b>209,00</b>
○ Branco 1180lm   2700K	<b>1006646</b>	<b>209,00</b>
○ Branco 1230lm   3000K	<b>1006648</b>	<b>209,00</b>
○ Branco 1250lm   4000K	<b>1006650</b>	<b>209,00</b>







**GRIP! S**  
48V, DALI, Ø 3,0cm



**GRIP! S**  
48V, DALI, Ø 3,0cm



**GRIP! S**  
48V, DALI, Ø 3,0cm

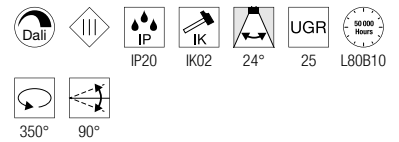
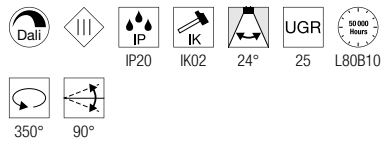
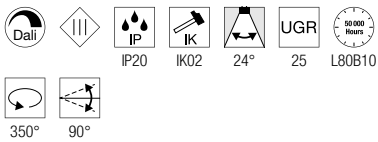
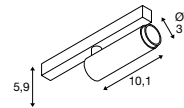
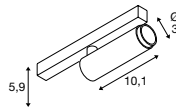
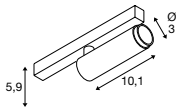

48 DC | 250mA  
Potência do sistema: 9,8W  
Material: alumínio

48 DC | 250mA  
Potência do sistema: 9,8W  
Material: alumínio

48 DC | 250mA  
Potência do sistema: 9,8W  
Material: alumínio

- Apenas compatível com a calha eletrificada saliente de 48V padrão

- Apenas compatível com a calha eletrificada saliente de 48V padrão

- Apenas compatível com a calha eletrificada saliente de 48V padrão



Down 550lm | 2700K



Down 620lm | 3000K



Down 320lm | 2000-3000K

Versão	Art. n.º	EUR
● Preto/dourado	1008407	169,00
● Branco/preto	1008405	169,00
● Dourado/preto	1008409	169,00
● Bronze/preto	1008408	169,00

Versão	Art. n.º	EUR
● Preto/dourado	1008412	169,00
● Branco/preto	1008410	169,00
● Dourado/preto	1008414	169,00
● Bronze/preto	1008413	169,00

Versão	Art. n.º	EUR
● Preto/dourado	1008417	169,00
● Branco/preto	1008415	169,00
● Dourado/preto	1008419	169,00
● Bronze/preto	1008418	169,00

1008456 531





**GRIP! S**  
48V, PD, DALI, Ø 3,0 cm

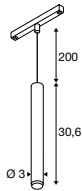

48 DC | 250mA  
Potência do sistema: 9,8W  
Material: alumínio



Down 550lm | 2700K

Versão	Art. n.º	EUR
● Preto/dourado	1008456	199,00
○ Branco/preto	1008454	199,00
● Dourado/preto	1008458	199,00
● Bronze/preto	1008457	199,00

**GRIP! S**  
48V, PD, DALI, Ø 3,0 cm

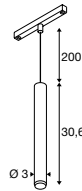

48 DC | 250mA  
Potência do sistema: 9,8W  
Material: alumínio



Down 620lm | 3000K

Versão	Art. n.º	EUR
● Preto/dourado	1008461	199,00
○ Branco/preto	1008459	199,00
● Dourado/preto	1008463	199,00
● Bronze/preto	1008462	199,00

**GRIP! S**  
48V, PD, DALI, Ø 3,0 cm

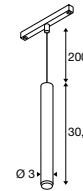

48 DC | 250mA  
Potência do sistema: 9,8W  
Material: alumínio



Down 320lm | 2000-3000K

Versão	Art. n.º	EUR
● Preto/dourado	1008466	199,00
○ Branco/preto	1008464	199,00
● Dourado/preto	1008468	199,00
● Bronze/preto	1008467	199,00

1007747 + 1007532 533 + 535





LALU® PD  
48V, LED Base, Mix&Match

MIX  
match

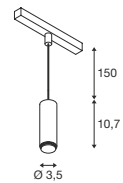

48V | 200mA  
Potência do sistema: 8W  
Material: alumínio

- Os abajures a condizer podem ser encontrados nas páginas 534-535



Down

700lm | 3000K

Versão	Art. n.º	EUR
● Preto	1007749	179,00
○ Branco	1007748	179,00
● Bronze	1007747	189,00



1007747 + 1007536 533 + 535

## LALU® TETRA 14

Abajur, Mix&Match

MIX  
match



A: 4,9 cm  
Ø: 14 cm  
Material: aço

Versão	Art. n.º	EUR
● Preto/bronze	1007523	55,00
● Branco/dourado	1007522	55,00
● Bronze	1007521	58,00



1007748 + 1007522 533 + 535

## LALU® TETRA 24

Abajur, Mix&Match

MIX  
match



A: 6,7 cm  
Ø: 24 cm  
Material: aço

Versão	Art. n.º	EUR
● Preto/bronze	1007526	72,00
● Branco/dourado	1007525	72,00
● Bronze	1007524	78,00



### LALU® ELYPSE 15

Abajur, Mix&Match

MIX  
match



A: 1,4 cm  
Ø: 15 cm  
Material: aço

Versão	Art. n.º	EUR
●● Preto/bronze	1007535	36,00
○● Branco/dourado	1007534	36,00
● Bronze	1007533	42,00

### LALU® PLATE 15

Abajur, Mix&Match

MIX  
match



A: 1,5 cm  
Ø: 15 cm  
Material: aço

Versão	Art. n.º	EUR
●● Preto/bronze	1007544	42,00
○● Branco/dourado	1007543	42,00
● Bronze	1007542	45,00

### LALU® CONE 15

Abajur, Mix&Match

MIX  
match



A: 17 cm  
Ø: 15,2 cm  
Material: aço

Versão	Art. n.º	EUR
●● Preto/bronze	1007532	57,00
○● Branco/dourado	1007531	57,00
● Bronze	1007530	65,00

### LALU® ELYPSE 22

Abajur, Mix&Match

MIX  
match



A: 2,8 cm  
Ø: 22 cm  
Material: aço

Versão	Art. n.º	EUR
●● Preto/bronze	1007538	57,00
○● Branco/dourado	1007537	57,00
● Bronze	1007536	65,00

### LALU® PLATE 22

Abajur, Mix&Match

MIX  
match



A: 1,5 cm  
Ø: 22 cm  
Material: aço

Versão	Art. n.º	EUR
●● Preto/bronze	1007547	55,00
○● Branco/dourado	1007546	55,00
● Bronze	1007545	59,00

# CRIE O SEU SISTEMA DE 48V

---

Selecione a sua Versão de calha eletrificada no comprimento certo, na cor desejada e com a instalação preferida. Decida-se pela Versão de montagem encastrada ou por uma das duas Versões salientes. Com as luminárias NUMINOS®, IN-LINE e GRIP especialmente concebidas para o sistema de 48V da SLV! SPOTS ou LALU® luminárias suspensas são particularmente flexíveis e enquadram perfeitamente o ambiente.

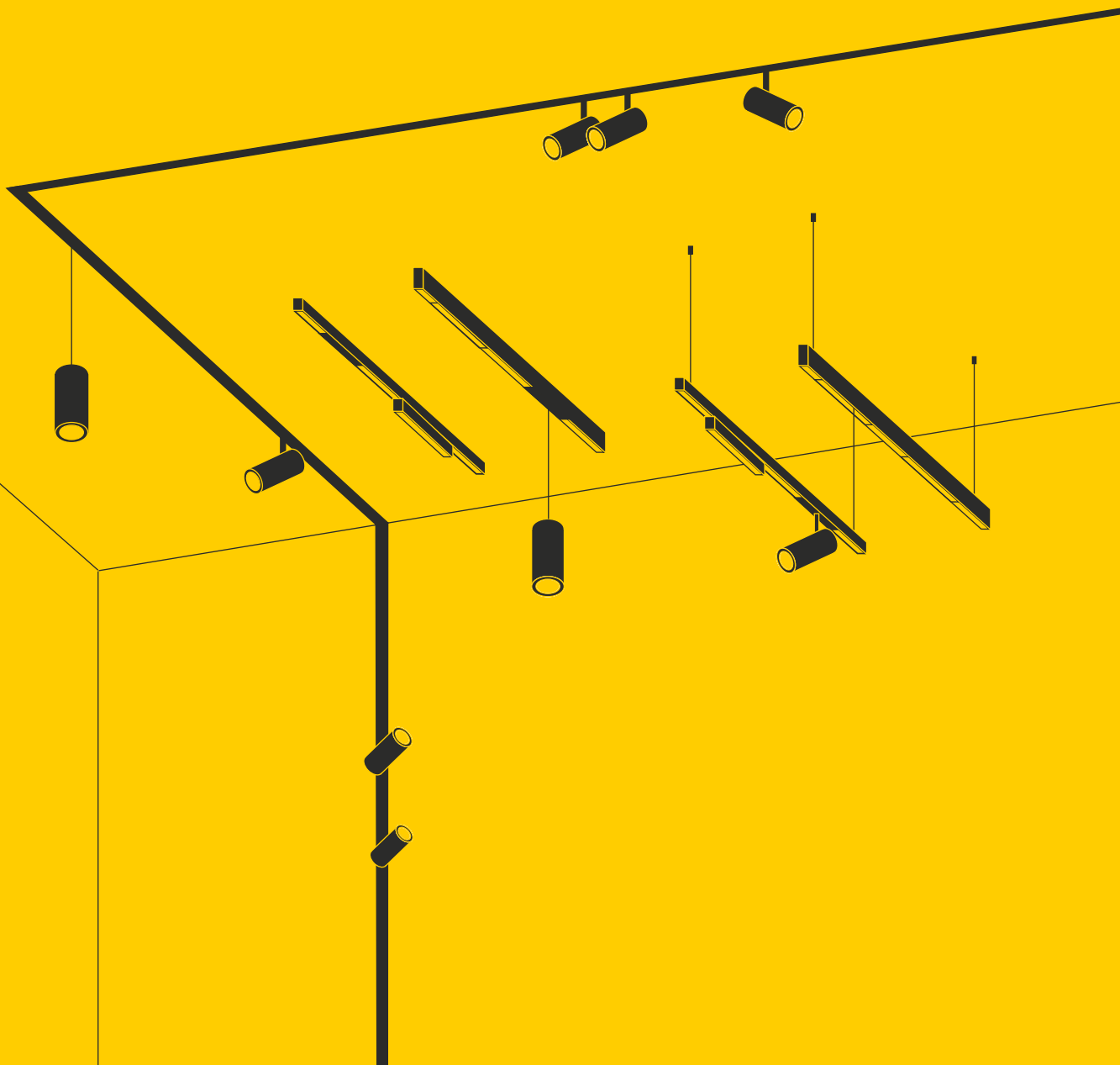



# SELECIONE O SEU TIPO DE INSTALAÇÃO PREFERIDO

**SALIENTE**

**ENCASTRADA**



Teto



Parede



Suspensa



Teto



Parede



## SELECIONE A SUA CALHA ELETRIFICADA

**CALHA ELETRIFICADA SA-  
LIENTE PADRÃO**



**CALHA ELETRIFICADA SA-  
LIENTE EM PROFUNDIDADE**

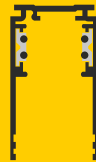

**CALHA ELETRIFICADA DE  
MONTAGEM ENCASTRADA  
PARA TETOS DE GESSO**

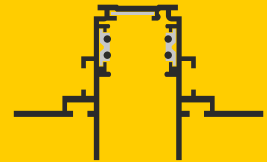

## SELECIONE OS SEUS ACESSÓRIOS

**DIVERSOS CONECTORES, COBERTURAS, SUSPENSÕES,  
FONTES DE ALIMENTAÇÃO E MUITO MAIS**



## SELECIONE AS SUAS LUMINÁRIAS

**POR EX. NUMINOS® SPOT  
E LUMINÁRIA SUSPensa**



**POR EX. IN-LINE, IN-LINE DARKLIGHT REFLECTOR  
E IN-LINE MOVE**



139100 547





**SCKET**

ASMARÁ | 544



**SCKET**

TELESKOP | 544



**SCKET**

COSMIC | 545



**SCKET**

SYROS | 547



**SCKET**

SALUNA | 547



**LED**

DURNO | 547



**LED**

PLYTTA | 548



**LED**

NOBLO SPOT | 549



**LED**

COMET LED | 549



**SCKET**

COMET | 549

TENSEO, Cabo de baixa tensão 4 mm<sup>2</sup>



	10 m	10 m	10 m
Intensidade máx. de corrente (A)	25	25	25
Cor	● Preto	○ Branco	○ Transparente
Material	Cobre/plástico	Cobre/plástico	Cobre/plástico
C (cm)	1000	1000	1000
Art. n.º	<b>1002602</b>	<b>1002603</b>	<b>1002604</b>
EUR	<b>29,25</b>	<b>29,25</b>	<b>29,25</b>

	20 m	20 m	20 m
Intensidade máx. de corrente (A)	25	25	25
Cor	● Preto	○ Branco	○ Transparente
Material	Cobre/plástico	Cobre/plástico	Cobre/plástico
C (cm)	2000	2000	2000
Art. n.º	<b>139030</b>	<b>139031</b>	<b>139024</b>
EUR	<b>48,75</b>	<b>48,75</b>	<b>48,75</b>

	100 m	100 m	100 m
Intensidade máx. de corrente (A)	25	25	25
Cor	● Preto	○ Branco	○ Transparente
Material	Cobre/plástico	Cobre/plástico	Cobre/plástico
C (cm)	10000	10000	10000
Art. n.º	<b>139040</b>	<b>139041</b>	<b>139004</b>
EUR	<b>244,00</b>	<b>244,00</b>	<b>244,00</b>



TENSEO, Cabo de baixa tensão 6 mm<sup>2</sup>



	20 m	20 m	20 m
Intensidade máx. de corrente (A)	25	25	25
Cor	● Preto	○ Branco	○ Transparente
Material	Cobre/plástico	Cobre/plástico	Cobre/plástico
C (cm)	2000	2000	2000
Art. n.º	139050	139051	139026
EUR	58,00	58,00	58,00

	100 m	100 m	100 m
Intensidade máx. de corrente (A)	25	25	25
Cor	● Preto	○ Branco	○ Transparente
Material	Cobre/plástico	Cobre/plástico	Cobre/plástico
C (cm)	10000	10000	10000
Art. n.º	139060	139061	139006
EUR	287,00	287,00	287,00



139131 547



**12 V CA | 50 VA convencional**  
Aço/latão  
A: 11 cm Ø: 11,1 cm

● Preto	Art. n.º	1002691	111,00 EUR
○ Branco		1002692	111,00 EUR
● Cromado		1002693	115,00 EUR



**12 V CA | 105 VA convencional**  
Aço/latão  
A: 11 cm Ø: 11,1 cm

○ Branco	Art. n.º	138981	135,00 EUR
● Cromado		138982	147,00 EUR



**12 V CA | 210 VA convencional**  
Aço/latão  
A: 11 cm Ø: 13,5 cm

○ Branco	Art. n.º	138991	204,00 EUR
● Cromado		138992	213,00 EUR



**Tensor de cabo**  
25 A máx. | Latão  
A: 11 cm Ø: 1 cm

● Preto	Art. n.º	181530	28,50 EUR
○ Branco		181531	28,50 EUR
● Cromado		181532	30,75 EUR



**Haste de suporte para parede**  
Aço/latão  
C: 3 cm Ø: 5 cm

● Preto	Art. n.º	186300	28,50 EUR
○ Branco		186301	28,50 EUR
● Cromado		186302	30,75 EUR



**Defletor 6 cm**  
Aço/latão  
A: 6 cm Ø: 5 cm

● Preto	Art. n.º	186330	24,50 EUR
○ Branco		186331	24,50 EUR
● Cromado		186332	28,50 EUR



**Defletor**  
Aço/latão  
A: 16 cm Ø: 5 cm

● Preto	Art. n.º	186340	28,50 EUR
○ Branco		186341	28,50 EUR
● Cromado		186342	30,75 EUR



**Haste de suporte para parede 10 cm**  
Aço/latão  
A: 11,5 cm Ø: 5 cm  
Com dispositivo de fixação

● Preto	Art. n.º	186310	40,50 EUR
○ Branco		186311	40,50 EUR
● Cromado		186312	42,75 EUR



**Defletor de teto**  
Aço/latão  
A: 16 cm Ø: 5 cm

● Preto	Art. n.º	186640	92,00 EUR
○ Branco		186641	92,00 EUR
● Cromado		186642	99,00 EUR



**Alimentador**  
25 A máx. | Latão  
A: 1,8 cm Ø: 1 cm

● Preto	Art. n.º	186350	12,20 EUR
○ Branco		186351	12,20 EUR
● Cromado		186352	13,70 EUR



**Conector isolante**  
25 A máx. | Alumínio/plástico  
C: 6,4 cm Ø: 1 cm

● Preto	Art. n.º	186360	22,75 EUR
○ Branco		186361	22,75 EUR
● Cromado		186362	24,50 EUR



**Espaceador**  
Alumínio  
L: 9 cm Ø: 1,25 cm

● Preto	Art. n.º	1002700	46,50 EUR
○ Branco		1002698	40,50 EUR
● Cromado		1002702	56,00 EUR



**Espaceador elétrico**  
25 A máx. | Latão  
A: 9 cm Ø: 1,25 cm

● Preto	Art. n.º	1002703	56,00 EUR
○ Branco		1002704	56,00 EUR
● Cromado		1002705	62,00 EUR



**Conjunto de suspensão 2 m**  
Aço/alumínio  
L: 18,6 cm Ø: 1,25 cm

● Preto	Art. n.º	1002697	40,50 EUR
○ Branco		1002698	40,50 EUR
● Cromado		1002699	42,75 EUR



## ASMARA LV, QR-C51

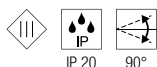
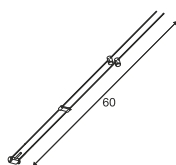
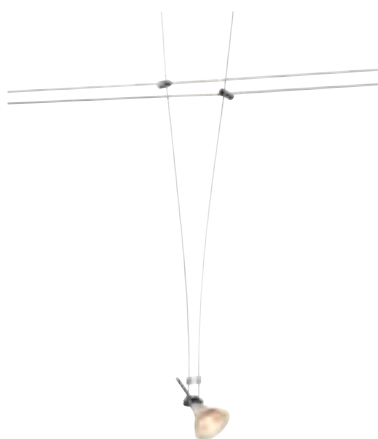

12V ~50Hz  
Material: aço inoxidável



Base: 1xGX5.3

Versão	Art. n.º	EUR
● Preto	139070	28,25
○ Branco	139071	28,25
● Cromado	139072	30,75



LED GU5.3 | 5,8W | 36°  
3000K | 450lm | CEE=G  
6kWh/1000h

Art. N.º: 1001575 | 35,00 EUR



## TELESKOP LV, QR-C51

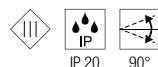

12V ~50Hz  
Material: aço

- Telescópio ajustável de 21 a 51 cm



Base: 1xGX5.3

Versão	Art. n.º	EUR
● Preto	139080	33,75
○ Branco	139081	33,75
● Cromado	139082	36,75



LED GU5.3 | 5,8W | 36°  
2700K | 450lm | CEE=G  
6kWh/1000h

Art. N.º: 1001574 | 35,00 EUR







**COSMIC**  
LV, QR-C51

139090 545

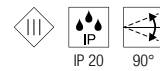
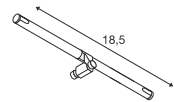

12V ~50Hz  
Material: aço/latão



Base: 1xGX5.3

Versão	Art. n.º	EUR
● Preto	<b>139090</b>	<b>40,25</b>
○ Branco	<b>139091</b>	<b>40,25</b>
● Cromado	<b>139092</b>	<b>42,50</b>



LED GU5.3 | 5,8W | 36°  
2700K | 450lm | CEE=G  
6kWh/1000h



Art. N.º: 1001574 | 35,00 EUR



139102 547

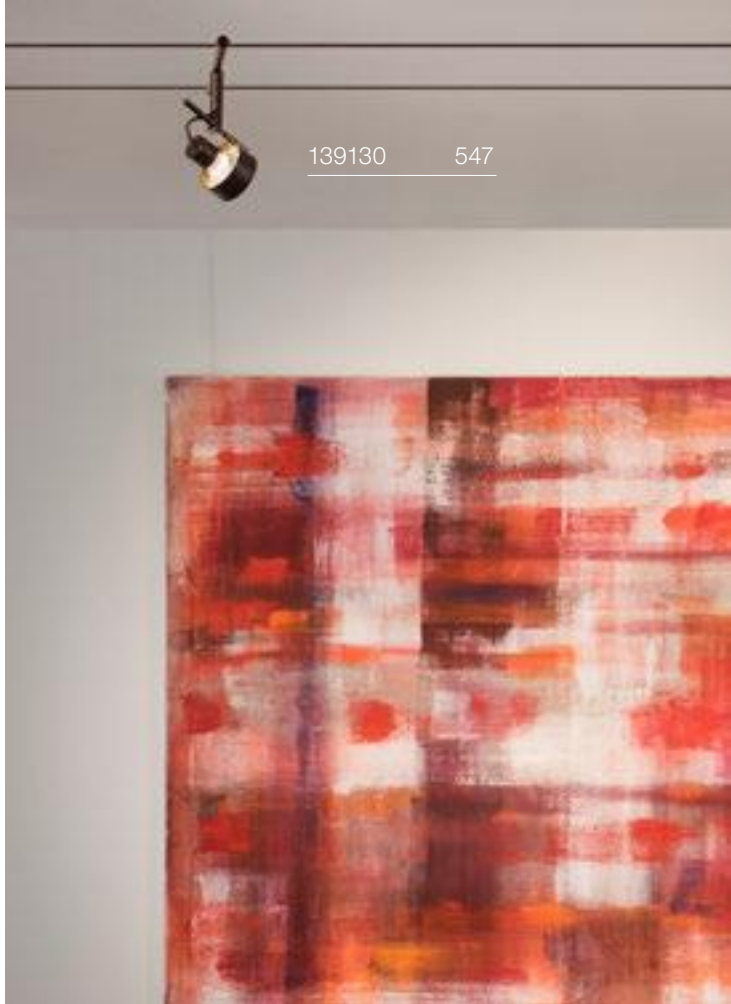

139130 547

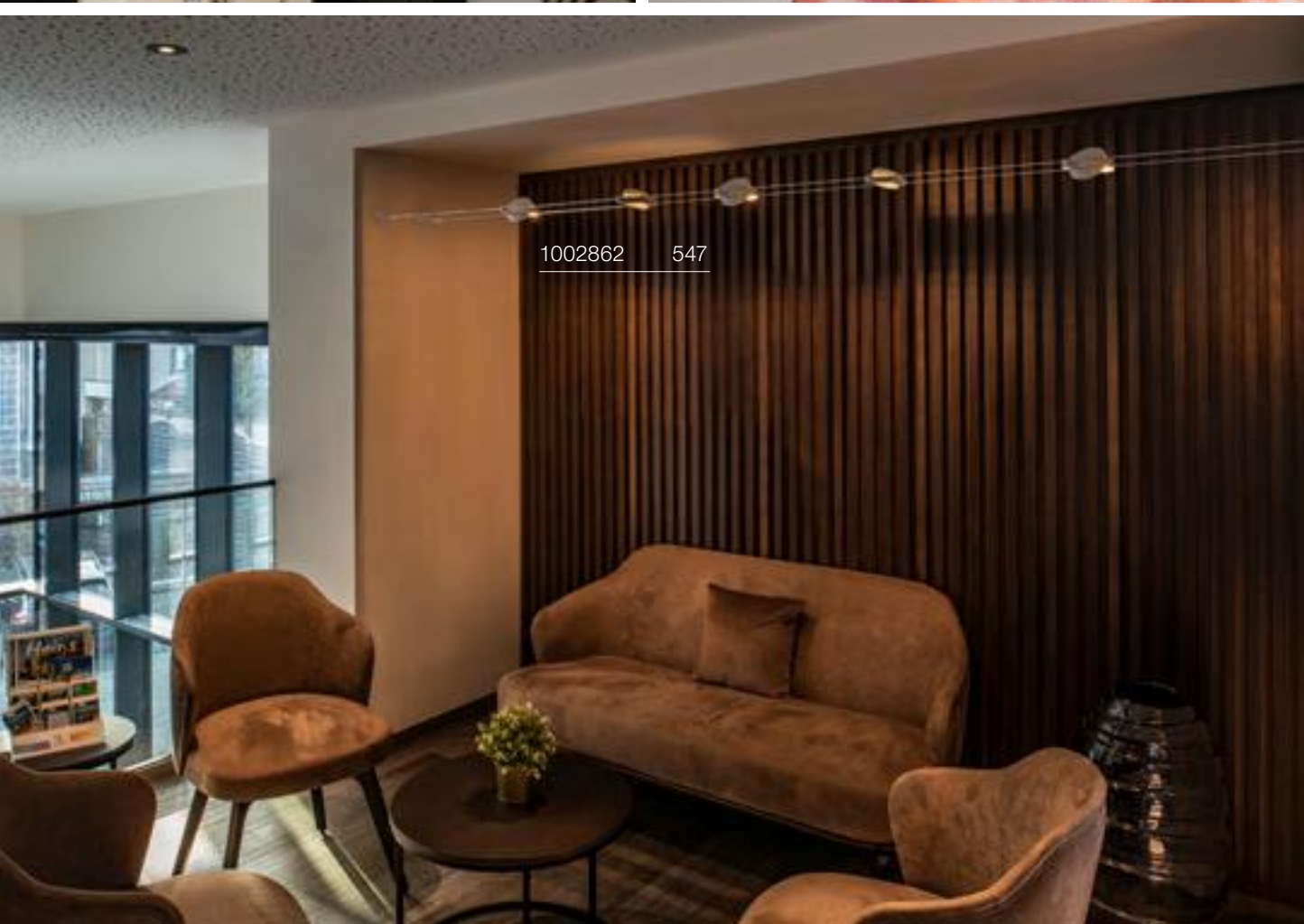

1002862 547



**SYROS**  
LV, QR-C51

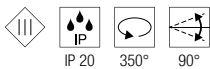
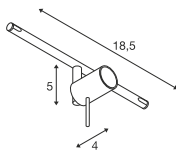

12V ~50Hz  
Material: aço



Base: 1xGX5.3

Versão	Art. n.º	EUR
● Preto	<b>139100</b>	<b>55,00</b>
○ Branco	<b>139101</b>	<b>55,00</b>
● Cromado	<b>139102</b>	<b>62,00</b>



LED GU5.3 | 5,8W | 36°  
2700K | 450lm | CEE=G  
6kWh/1000h

Art. N.º: **1001574** | **35,00 EUR**



**SALUNA**  
LV, QR-C51

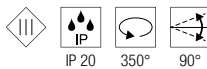
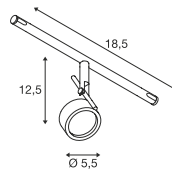

12V ~50Hz  
Material: aço/latão



Base: 1xGX5.3

Versão	Art. n.º	EUR
● Preto	<b>139130</b>	<b>72,00</b>
○ Branco	<b>139131</b>	<b>72,00</b>
● Cromado	<b>139132</b>	<b>78,00</b>



LED GU5.3 | 5,8W | 36°  
3000K | 450lm | CEE=G  
6kWh/1000h

Art. N.º: **1001575** | **35,00 EUR**



**DURNO**  
LV

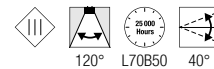
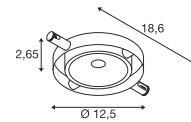

12V ~50Hz  
Consumo de energia: 6W  
Material: alumínio/aço inoxidável



Down

360lm | 2700K

Versão	Art. n.º	EUR
● Preto	<b>1002861</b>	<b>82,00</b>
○ Branco	<b>1002862</b>	<b>82,00</b>
● Cromado/aço inoxidável	<b>1002863</b>	<b>86,00</b>

1002864 548



## PLYTTA LV

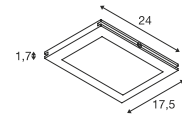

1002690 549

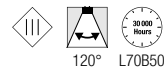

12V ~50Hz  
Consumo de energia: 9,8W  
Material: alumínio/plástico



Down

750lm | 2700K

Versão	Art. n.º	EUR
● Preto IRC80	1002864	65,00
○ Branco IRC90	1002865	65,00
● Cromado IRC90	1002866	70,00



## NOBLO SPOT LV, Rope Track

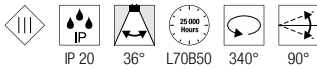
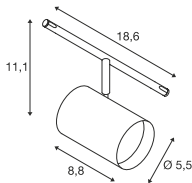

12V ~50Hz  
Consumo de energia: 8,5W  
Material: alumínio



Down 420lm | 2700K  
450lm

Versão	Art. n.º	EUR
● Preto		
420lm	<b>1002694</b>	<b>80,00</b>
○ Branco		
450lm	<b>1002695</b>	<b>80,00</b>
● Cromado		
450lm	<b>1002696</b>	<b>85,00</b>

## COMET LED LV

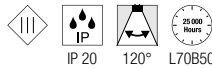
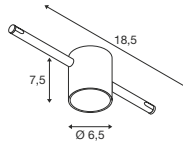

12V ~50Hz  
Consumo de energia: 6,6W  
Material: alumínio/vidro



Down 410lm | 2700K

Versão	Art. n.º	EUR
● Cromado/fosco	<b>1002690</b>	<b>83,00</b>

## COMET LV, QR-C51

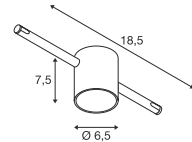

12V ~50Hz  
Material: latão



Base: 1xGU5.3

Versão	Art. n.º	EUR
● Preto	<b>139120</b>	<b>55,00</b>
○ Branco	<b>139121</b>	<b>55,00</b>
● Cromado	<b>139122</b>	<b>62,00</b>



LED GU5.3 | 5,8W | 36°  
2700K | 450lm | CEE=G  
6kWh/1000h

Art. N.º: **1001574** | **35,00 EUR**





NEW

LED  
QUIMERA | 559



NEW

SCKET  
FORCHINI M  
40 TRACK | 561



NEW

SCKET  
PURI 2.0 | 563



NEW

SCKET  
PURI 2.0 | 563



NEW

SCKET  
PURI 2.0 | 563



NEW

SCKET  
PURI 2.0 | 565



NEW

SCKET  
PURI 2.0 | 565



NEW

SCKET  
PURI 2.0 | 565



NEW

SCKET  
PURI 2.0 | 566



NEW

SCKET  
PURI 2.0 | 567



NEW

PURI 2.0 | 567



NEW

PURI 2.0 | 567



NEW

PURI 2.0 | 567



NEW

LED  
GRIP! S | 569



NEW

LED  
GRIP! S | 569



NEW

LED  
GRIP! S | 569



NEW

LED  
GRIP! M | 571



NEW

LED  
GRIP! M | 571



NEW

LED  
GRIP! M | 571



NEW

SCKET  
GRIP! L | 573



NEW

SCKET  
GRIP! L | 573



NEW

SCKET  
LIGHT EYE® 90 | 576



NEW

SCKET  
LIGHT EYE® 150 | 577



NEW

SCKET  
LIGHT EYE® 90 | 579



NEW

SCKET  
LIGHT EYE® 150 | 579



SCKET  
KALU TRACK | 581



LED  
KALU TRACK | 581



LED  
NOBLO SPOT | 582



LED  
NOBLO SPOT | 582



LED  
NOBLO SPOT | 583



LED  
NOBLO SPOT | 583



SCKET  
ASTO TUBE | 585



SCKET  
PANTILO  
ROPE 19 | 585



SCKET  
PARA CONE GL | 587



SCKET  
PARA CONE 14 | 587



SCKET  
PARA CONE 14 | 587



LED  
HELIA 50 TRACK | 589



LED  
PANEL TRACK | 589



LED  
PANEL TRACK | 589



SCKET  
PURI TRACK | 591



SCKET  
PURI TRACK | 591



SCKET  
TONGA® | 592



**S**CKET

PURIA TRACK | 593



**S**CKET

AVO TRACK | 593



**LED**

ENOLA C TRACK | 594



**LED**

ENOLA C TRACK | 594



**S**CKET

ENOLA B TRACK | 595



**S**CKET

ENOLA B | 595



**LED**

BIMA | 597



**S**CKET

BIMA | 597



**S**CKET

EURO SPOT  
TRACK | 598



**S**CKET

ALTRA DICE  
TRACK | 599







## MONOFÁSICO

Calha eletrificada saliente



	1 m	1 m	1 m
Tensão nominal (V)	220-240V ~50/60Hz	220-240V ~50/60Hz	220-240V ~50/60Hz
Intensidade máx. de corrente (A)	16	16	16
Cor	● Preto	○ Branco	● Cinzento
Material	Alumínio	Alumínio	Alumínio
C x L x A (cm)	100 x 3,5 x 1,8	100 x 3,5 x 1,8	100 x 3,5 x 1,8
Art. n.º	143010	143011	143012
EUR	35,50	35,50	35,50

	2 m	2 m	2 m
Tensão nominal (V)	220-240V ~50/60Hz	220-240V ~50/60Hz	220-240V ~50/60Hz
Intensidade máx. de corrente (A)	16	16	16
Cor	● Preto	○ Branco	● Cinzento
Material	Alumínio	Alumínio	Alumínio
C x L x A (cm)	200 x 3,5 x 1,8	200 x 3,5 x 1,8	200 x 3,5 x 1,8
Art. n.º	143020	143021	143022
EUR	67,00	67,00	67,00

	3 m	3 m	3 m
Tensão nominal (V)	220-240V ~50/60Hz	220-240V ~50/60Hz	220-240V ~50/60Hz
Intensidade máx. de corrente (A)	16	16	16
Cor	● Preto	○ Branco	● Cinzento
Material	Alumínio	Alumínio	Alumínio
C x L x A (cm)	300 x 3,5 x 1,8	300 x 3,5 x 1,8	300 x 3,5 x 1,8
Art. n.º	1002151	1002152	1002153
EUR	100,00	100,00	100,00

# MONOFÁSICO

Guia de planeamento de calha eletrificada saliente e visão geral de acessórios

Vista de cima dos componentes no lado da montagem

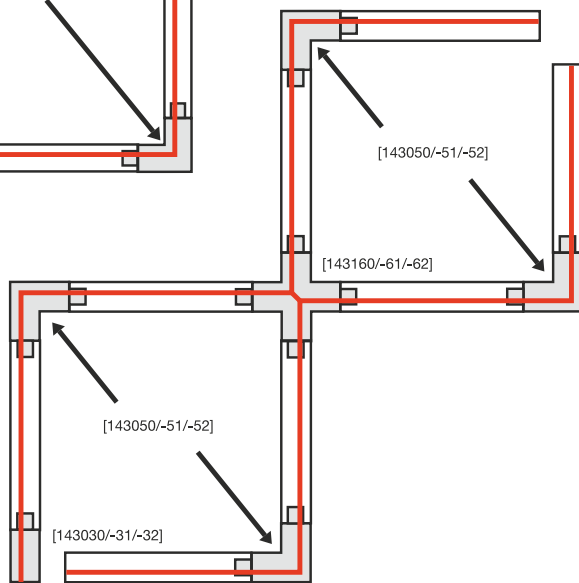
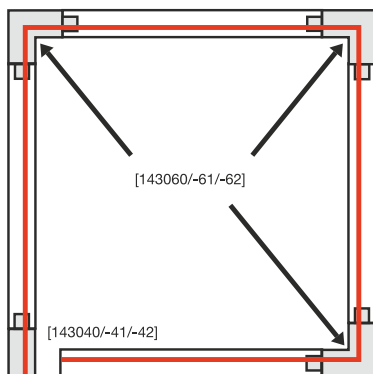
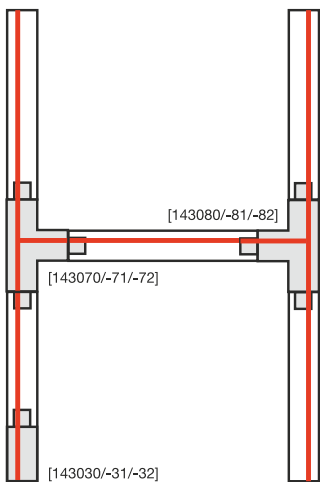
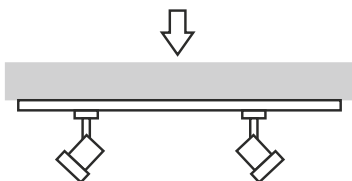

### Adaptador monof.

Policarbonato (PC)  
C: 8,5 cm | L: 3,5 cm | A: 3,2 cm

- Preto Art. n.º 143120 15,00 EUR
- Branco 143121 15,00 EUR
- Cinzento 143124 15,00 EUR



### Adaptador monof. com gancho

6 A máx. | Policarbonato (PC)  
C: 8,5 cm | L: 3,5 cm | A: 7,4 cm

- Preto Art. n.º 143170 15,00 EUR
- Branco 143171 15,00 EUR
- Cinzento 143172 15,00 EUR



**Alimentador, terra esquerda**  
16 A máx. | Policarbonato (PC)  
C: 6,5 cm | L: 3,5 cm | A: 1,8 cm

● Preto	Art. n.º	<b>143030</b>	<b>9,35 EUR</b>
○ Branco		<b>143031</b>	<b>9,35 EUR</b>
● Cinzento		<b>143032</b>	<b>9,35 EUR</b>



**Alimentador, terra direita**  
16 A máx. | Policarbonato (PC)  
C: 6,5 cm | L: 3,5 cm | A: 1,8 cm

● Preto	Art. n.º	<b>143040</b>	<b>9,35 EUR</b>
○ Branco		<b>143041</b>	<b>9,35 EUR</b>
● Cinzento		<b>143042</b>	<b>9,35 EUR</b>



**Conectores longitudinais com opção de alimentação**  
16 A máx. | Policarbonato (PC)  
C: 17,2 cm | L: 3,5 cm | A: 1,8 cm

● Preto	Art. n.º	<b>143100</b>	<b>17,50 EUR</b>
○ Branco		<b>143101</b>	<b>17,50 EUR</b>
● Cinzento		<b>143102</b>	<b>17,50 EUR</b>



**Conector longitudinal, elétrico**  
16 A máx. | Policarbonato (PC)  
C: 6,4 cm | L: 3,5 cm | A: 1,8 cm

● Preto	Art. n.º	<b>143090</b>	<b>7,10 EUR</b>
○ Branco		<b>143091</b>	<b>7,10 EUR</b>
● Cinzento		<b>143092</b>	<b>7,10 EUR</b>



**Conector em L, terra interior**  
16 A máx. | Policarbonato (PC)  
C: 10,4 cm | L: 10,4 cm | A: 1,8 cm

● Preto	Art. n.º	<b>143060</b>	<b>16,40 EUR</b>
○ Branco		<b>143061</b>	<b>16,40 EUR</b>
● Cinzento		<b>143062</b>	<b>16,40 EUR</b>



**Conector em L, terra exterior**  
16 A máx. | Policarbonato (PC)  
C: 10,4 cm | L: 10,4 cm | A: 1,8 cm

● Preto	Art. n.º	<b>143050</b>	<b>16,40 EUR</b>
○ Branco		<b>143051</b>	<b>16,40 EUR</b>
● Cinzento		<b>143052</b>	<b>16,40 EUR</b>



**Conector em T, terra exterior, esquerda**  
16 A máx. | Policarbonato (PC)  
C: 17,2 cm | L: 10,4 cm | A: 1,8 cm

● Preto	Art. n.º	<b>143070</b>	<b>20,75 EUR</b>
○ Branco		<b>143071</b>	<b>20,75 EUR</b>
● Cinzento		<b>143072</b>	<b>20,75 EUR</b>



**Conector em T, terra exterior, direita**  
16 A máx. | Policarbonato (PC)  
C: 17,2 cm | L: 10,4 cm | A: 1,8 cm

● Preto	Art. n.º	<b>143080</b>	<b>20,75 EUR</b>
○ Branco		<b>143081</b>	<b>20,75 EUR</b>
● Cinzento		<b>143082</b>	<b>20,75 EUR</b>



**Conector em X**  
16 A máx. | Policarbonato (PC)  
C: 9,5 cm | L: 17,2 cm | A: 1,8 cm

● Preto	Art. n.º	<b>143160</b>	<b>31,25 EUR</b>
○ Branco		<b>143161</b>	<b>31,25 EUR</b>
● Cinzento		<b>143162</b>	<b>31,25 EUR</b>



**Conector flex.**  
16 A máx. | Policarbonato (PC)  
C: 16,4 cm | L: 3,5 cm | A: 1,8 cm

● Preto	Art. n.º	<b>143110</b>	<b>17,50 EUR</b>
○ Branco		<b>143111</b>	<b>17,50 EUR</b>
● Cinzento		<b>143112</b>	<b>17,50 EUR</b>



**Estabilizador, conector longitudinal comprido**  
Aço  
C: 19,7 cm | L: 3,2 cm | A: 1,3 cm  
Para reforço ao instalar várias calhas eletrificadas com suspensão para teto (1002845)

● Níquel	Art. n.º	<b>143151</b>	<b>7,10 EUR</b>
----------	----------	---------------	-----------------



**Estabilizador, ligador em L comprido**  
Aço  
C: 11,5 cm | L: 11,5 cm | A: 0,5 cm  
Para reforço ao instalar várias calhas eletrificadas com suspensão para teto (1002845)

● Níquel	Art. n.º	<b>143152</b>	<b>8,25 EUR</b>
----------	----------	---------------	-----------------



**Estabilizador de conector em X**  
Aço  
C: 19,7 cm | L: 19,7 cm | A: 0,5 cm  
Para reforço ao instalar várias calhas eletrificadas com suspensão para teto (1002845).

● Níquel	Art. n.º	<b>143169</b>	<b>12,50 EUR</b>
----------	----------	---------------	------------------



**Cobertura para calha eletrificada saliente monofásica, 2 m**  
Policarbonato (PC)  
C: 200 cm | L: 1,8 cm | A: 0,75 cm

● Preto	Art. n.º	<b>1004783</b>	<b>21,00 EUR</b>
○ Branco		<b>1004785</b>	<b>21,00 EUR</b>
● Cinzento		<b>1004784</b>	<b>21,00 EUR</b>



**Tampa (2 un.)**  
Policarbonato (PC)  
C: 0,4 cm | L: 3,5 cm | A: 1,8 cm

● Preto	Art. n.º	<b>143130</b>	<b>4,40 EUR</b>
○ Branco		<b>143131</b>	<b>4,40 EUR</b>
● Cinzento		<b>143132</b>	<b>4,40 EUR</b>



**Roseta para teto 2.0**  
6 A máx. | Policarbonato (PC)  
A: 2,5 cm | Ø: 11,5 cm

● Preto	Art. n.º	<b>1007926</b>	<b>20,75 EUR</b>
○ Branco		<b>1007927</b>	<b>20,75 EUR</b>
● Cinzento		<b>1007928</b>	<b>20,75 EUR</b>



**Suspensão de cabos de aço (2 un.)**  
Aço inoxidável/latão  
C: 500 cm

● Níquel	Art. n.º	<b>1002845</b>	<b>41,75 EUR</b>
----------	----------	----------------	------------------



**Placa de cobertura monof.**  
Aço  
C: 10 cm | L: 10 cm | A: 0,04 cm

● Preto	Art. n.º	<b>1008149</b>	<b>15,00 EUR</b>
○ Branco		<b>1008148</b>	<b>15,00 EUR</b>
● Cinzento		<b>1008150</b>	<b>15,00 EUR</b>

143580 589





# MONOFÁSICO

Calha eletrificada de montagem encastrada



	<b>2 m</b>
Tensão nominal (V)	250V ~50/60Hz
Intensidade máx. de corrente (A)	16
Cor	<input type="radio"/> Branco
Material	Alumínio
C x L x A (cm)	200 x 5,5 x 1,8
Art. n.º	<b>143221</b>
EUR	<b>74,00</b>



**Alimentador, terra esquerda**  
16 A máx. | Plástico  
C: 10,8 cm | L: 5,5 cm | A: 2 cm  
Lig. terra esquerda

Branco Art. n.º **143231** **13,90 EUR**



**Alimentador, terra direita**  
16 A máx. | Plástico  
C: 10,8 cm | L: 5,5 cm | A: 2 cm  
Alimentador direito

Branco Art. n.º **143241** **13,90 EUR**

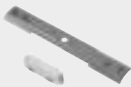

**Conectores longitudinais incl. reforço longitudinal**  
16 A máx. | Plástico/Aço  
C: 6,5 cm | L: 1,8 cm | A: 1,7 cm  
Conectores longitudinais incl. reforço longitudinal

Branco Art. n.º **143271** **13,90 EUR**



**Conector em L, terra interior**  
16 A máx. | Plástico  
C: 11,2 cm | L: 11,2 cm | A: 2 cm  
Lig. terra interior

Branco Art. n.º **143261** **20,75 EUR**



**Conector em L, terra exterior**  
16 A máx. | Plástico  
C: 11,2 cm | L: 11,2 cm | A: 2 cm  
Lig. terra exterior

Branco Art. n.º **143251** **20,75 EUR**



**Tampa**  
Plástico  
C: 2,7 cm | L: 5,5 cm | A: 1,8 cm  
Tampa

Branco Art. n.º **143281** **7,10 EUR**



**Acessório de fixação para teto falso**  
Aço  
C: 7,5 cm | L: 1,5 cm | A: 4 cm

Níquel Art. n.º **143230** **3,80 EUR**



**Adaptador monof. com gancho**  
6 A máx. | 2 kg máx. | Policarbonato (PC)  
C: 8,5 cm | L: 3,5 cm | A: 7,4 cm  
Monof. Adaptador com gancho

Preto Art. n.º **143170** **15,00 EUR**  
 Branco **143171** **15,00 EUR**  
 Cinzento **143172** **15,00 EUR**



**Adaptador monof.**  
2 kg máx. | Policarbonato (PC)  
C: 8,5 cm | L: 3,5 cm | A: 3,2 cm

Preto Art. n.º **143120** **15,00 EUR**  
 Branco **143121** **15,00 EUR**  
 Cinzento **143124** **15,00 EUR**



1008042 559



# QUIMERA

Monof., PD

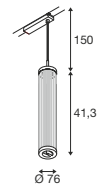

220-240V ~50/60Hz | 350mA  
 Potência do sistema: 8W  
 Material: alumínio/vidro

- Emissão de luz indireta através das linhas cortadas no vidro



Down

330lm | 2700K

Versão	Art. n.º	EUR
● Latão (PVD)	<b>1008042</b>	● <b>369,00</b>
● Cobre escuro (PVD)	<b>1008043</b>	● <b>369,00</b>
● Bronze escuro (PVD)	<b>1008041</b>	● <b>369,00</b>

1008540 561







## FORCHINI M 40 TRACK Monof., PD, E27

NEW

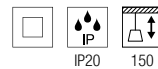
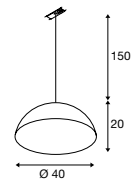

220-240V ~50/60Hz  
Material: aço/alumínio

- 1008539 com adaptador branco
- 1008540 com adaptador preto

**SOCKET INSIDE** <40 W

Casquilho: 1xE27 Máx. Ø: 6,8 cm | C: 15,2 cm

Versão	Art. n.º	EUR
● Preto/dourado	<b>1008539</b>	<b>233,00</b>
● Preto/dourado	<b>1008540</b>	<b>233,00</b>



LED E27 | 7,5W | 320°  
2500K | 700lm | CEE=F  
8 kWh/1000h



Art. N.º: **1005265** | **26,50 EUR**

1008250 563





PURI 2.0  
Tube Monof., QPAR51

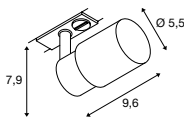

220-240V ~50/60Hz  
Material: alumínio



Casquilha: 1xGU10 Máx. Ø: 5,1 cm | C: 5,5 cm

Versão	Art. n.º	EUR
● Preto	1008242	39,00
● Preto/dourado	1008243	39,00
○ Branco	1008244	39,00
● Cinzento	1008245	39,00



LED GU10 51 mm | 6W | 36°  
2200-2700K | 360lm | CEE=G  
6 kWh/1000h



Art. N.º: 1005273 | 9,99 EUR

PURI 2.0  
Cone Monof., QPAR51

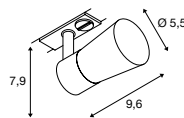

220-240V ~50/60Hz  
Material: alumínio



Casquilha: 1xGU10 Máx. Ø: 5,1 cm | C: 5,5 cm

Versão	Art. n.º	EUR
● Preto	1008246	39,00
● Preto/dourado	1008247	39,00
○ Branco	1008248	39,00
● Cinzento	1008249	39,00



LED GU10 51 mm | 6W | 38°  
3000K | 470lm | CEE=F  
6 kWh/1000h



Art. N.º: 1005080 | 7,50 EUR

PURI 2.0  
Dome Monof., QPAR51

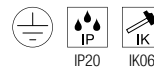
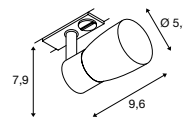

220-240V ~50/60Hz  
Material: alumínio



Casquilha: 1xGU10 Máx. Ø: 5,1 cm | C: 5,5 cm

Versão	Art. n.º	EUR
● Preto	1008250	39,00
● Preto/dourado	1008251	39,00
○ Branco	1008252	39,00
● Cinzento	1008253	39,00



LED GU10 51 mm | 6W | 36°  
2200-2700K | 360lm | CEE=G  
6 kWh/1000h



Art. N.º: 1005273 | 9,99 EUR

1008263 565





PURI 2.0  
Tube PD, Monof., QPAR51

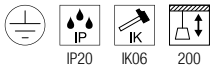
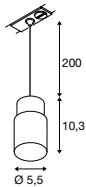

220-240V ~50/60Hz  
Material: alumínio



Casquilho: 1xGU10 Máx. Ø: 5,1 cm | C: 5,5 cm

Versão	Art. n.º	EUR
● Preto	1008254	44,00
● Preto/dourado	1008255	44,00
○ Branco	1008256	44,00
● Cinzento	1008257	44,00



LED GU10 51 mm | 6W | 36°  
2200-2700K | 360lm | CEE=G  
6 kWh/1000h



Art. N.º: 1005273 | 9,99 EUR

PURI 2.0  
Cone PD, Monof., QPAR51

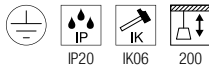
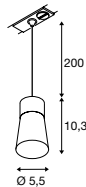

220-240V ~50/60Hz  
Material: alumínio



Casquilho: 1xGU10 Máx. Ø: 5,1 cm | C: 5,5 cm

Versão	Art. n.º	EUR
● Preto	1008258	44,00
● Preto/dourado	1008259	44,00
○ Branco	1008260	44,00
● Cinzento	1008261	44,00



LED GU10 51 mm | 6W | 38°  
3000K | 470lm | CEE=F  
6 kWh/1000h



Art. N.º: 1005078 | 7,50 EUR

PURI 2.0  
Dome PD, Monof., QPAR51

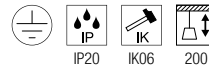
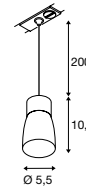

220-240V ~50/60Hz  
Material: alumínio



Casquilho: 1xGU10 Máx. Ø: 5,1 cm | C: 5,5 cm

Versão	Art. n.º	EUR
● Preto	1008262	44,00
● Preto/dourado	1008263	44,00
○ Branco	1008264	44,00
● Cinzento	1008265	44,00



LED GU10 51 mm | 6W | 36°  
2200-2700K | 360lm | CEE=G  
6 kWh/1000h



Art. N.º: 1005273 | 9,99 EUR

1008207 + 1008226 567



## PURI 2.0 Basic Monof., QPAR51

MIX  
match

NEW

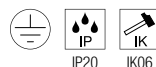
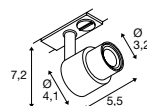

220-240V ~50/60Hz

Material: alumínio

- Pode encontrar abajures a condizer na página 567

**SOCKET INSIDE** 6 W

Casquilho: 1xGU10 Máx. Ø: 5,1 cm | C: 5,5 cm

Versão	Art. n.º	EUR
● Preto	1008356	35,00
○ Branco	1008357	35,00
● Cinzento	1008358	35,00



LED GU10 51 mm | 6W | 38°  
2700K | 450lm | CEE=F  
6 kWh/1000h



Art. N.º: 1005075 | 7,50 EUR



### PURI 2.0 Basic PD, Monof., QPAR51

MIX  
match

NEW

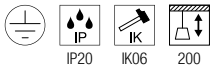
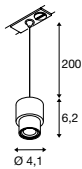

220-240V ~50/60Hz  
Material: alumínio

- Pode encontrar abajures a condizer na página 567



Casquilho: 1xGU10 Máx. Ø: 5,1 cm | C: 5,5 cm

Versão	Art. n.º	EUR
● Preto	1008207	35,00
○ Branco	1008208	35,00
● Cinzento	1008209	35,00



LED GU10 51 mm | 6W | 38°  
2700K | 450lm | CEE=F  
6 kWh/1000h



Art. N.º: 1005077 | 7,50 EUR

### PURI 2.0 Cone Abajur

MIX  
match

NEW



A: 6,5 cm  
Ø: 5,5 cm  
Material: alumínio

Versão	Art. n.º	EUR
● Preto	1008219	9,00
○ Branco	1008218	9,00
● Dourado	1008221	9,00
● Alumínio	1008377	9,00
● Cinzento	1008220	9,00
● Bronze	1008222	9,00

### PURI 2.0 Dome Abajur

MIX  
match

NEW



A: 6,5 cm  
Ø: 5,5 cm  
Material: alumínio

Versão	Art. n.º	EUR
● Preto	1008224	9,00
○ Branco	1008223	9,00
● Dourado	1008226	9,00
● Alumínio	1008378	9,00
● Cinzento	1008225	9,00
● Bronze	1008227	9,00

### PURI 2.0 Tube Abajur

MIX  
match

NEW



A: 6,5 cm  
Ø: 5,5 cm  
Material: alumínio

Versão	Art. n.º	EUR
● Preto	1008214	9,00
○ Branco	1008213	9,00
● Dourado	1008216	9,00
● Alumínio	1008376	9,00
● Cinzento	1008215	9,00
● Bronze	1008217	9,00







GRIP! S  
Monof.

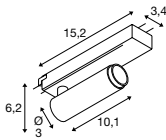

220-240V ~50/60Hz | 250mA  
Potência do sistema: 11W  
Material: alumínio



Down 550lm | 2700K

Versão	Art. n.º	EUR
● Preto/dourado	1008392	169,00
○ Branco/Preto	1008390	169,00
● Dourado/preto	1008394	169,00
● Bronze/preto	1008393	169,00

GRIP! S  
Monof.

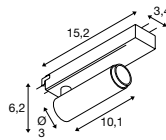

220-240V ~50/60Hz | 250mA  
Potência do sistema: 11W  
Material: alumínio



Down 620lm | 3000K

Versão	Art. n.º	EUR
● Preto/dourado	1008397	169,00
○ Branco/Preto	1008395	169,00
● Dourado/preto	1008399	169,00
● Bronze/preto	1008398	169,00

GRIP! S  
Monof., PHASE, Ø 3,0 cm

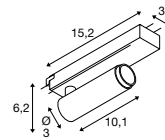

220-240V ~50/60Hz | 250mA  
Potência do sistema: 11W  
Material: alumínio



Down 320lm | 2000-3000K

Versão	Art. n.º	EUR
● Preto/dourado	1008402	169,00
○ Branco/Preto	1008400	169,00
● Dourado/preto	1008404	169,00
● Bronze/preto	1008403	169,00





GRIP! M  
Monof., PHASE, Ø 4,3 cm

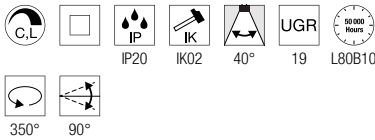
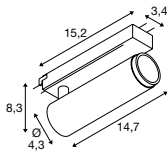

220-240V ~50/60Hz | 500mA  
Potência do sistema: 20W  
Material: alumínio



Down 1910lm | 2700K

Versão	Art. n.º	EUR
● Preto/dourado	1008422	179,00
○ Branco/Preto	1008420	179,00
● Dourado/preto	1008424	179,00
● Bronze/preto	1008423	179,00

GRIP! M  
Monof., PHASE, Ø 4,3 cm

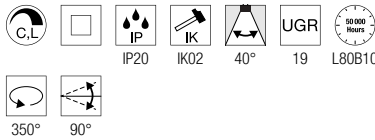
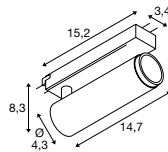

220-240V ~50/60Hz | 500mA  
Potência do sistema: 20W  
Material: alumínio



Down 2040lm | 3000K

Versão	Art. n.º	EUR
● Preto/dourado	1008427	179,00
○ Branco/Preto	1008425	179,00
● Dourado/preto	1008429	179,00
● Bronze/preto	1008428	179,00

GRIP! M  
Monof., PHASE, Ø 4,3 cm

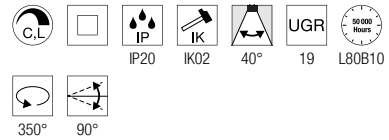
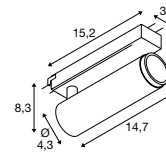

220-240V ~50/60Hz | 350mA  
Potência do sistema: 15W  
Material: alumínio



Down 780lm | 1800K - 3000lm | 3000K

Versão	Art. n.º	EUR
● Preto/dourado	1008432	179,00
○ Branco/Preto	1008430	179,00
● Dourado/preto	1008434	179,00
● Bronze/preto	1008433	179,00

1008473

573





**GRIP! L**  
Monof., QPAR51, Ø 5,7cm

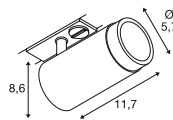

220-240V ~50/60Hz  
Material: alumínio



Casquilho: 1xGU10 Máx. Ø: 5,1 cm | C: 5,4 cm

Versão	Art. n.º	EUR
● Preto/dourado	1008449	89,00
● Branco/Preto	1008447	89,00
● Dourado/preto	1008451	89,00
● Bronze/preto	1008450	89,00



LED GU10 51 mm | 6W | 38°  
2700K | 450lm | CEE=F  
6 kWh/1000h



Art. N.º: 1005076 | 7,50 EUR

**GRIP! L**  
Monof., PD, QPAR51, Ø 5,7 cm

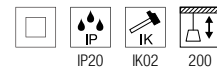
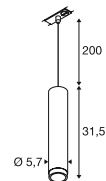

220-240V ~50/60Hz  
Material: alumínio



Casquilho: 1xGU10 Máx. Ø: 5,1 cm | C: 5,4 cm

Versão	Art. n.º	EUR
● Preto/dourado	1008471	139,00
● Branco/Preto	1008469	139,00
● Dourado/preto	1008473	139,00
● Bronze/preto	1008472	139,00



LED GU10 51 mm | 6W | 36°  
2200-2700K | 360lm | CEE=G  
6 kWh/1000h



Art. N.º: 1005273 | 9,99 EUR

1008473 + 1008499 573 + 575





**GRIP! S**  
Anel decorativo Ø 2,7 cm



A: 1,1 cm  
Ø: 2,7 cm  
Material: alumínio

**GRIP! M**  
Anel decorativo Ø 4,0 cm



A: 1,4 cm  
Ø: 4 cm  
Material: alumínio

**GRIP! L**  
Anel decorativo Ø 5,4 cm



A: 3,4 cm  
Ø: 5,4 cm  
Material: alumínio

Versão	Art. n.º	EUR
● Preto	1008489	18,00
○ Branco	1008488	18,00
● Dourado	1008491	18,00
● Níquel	1008490	18,00

Versão	Art. n.º	EUR
● Preto	1008493	20,00
○ Branco	1008492	20,00
● Dourado	1008495	20,00
● Níquel	1008494	20,00

Versão	Art. n.º	EUR
● Preto	1008497	22,00
○ Branco	1008496	22,00
● Dourado	1008499	22,00
● Níquel	1008498	22,00

LIGHT EYE® 90  
Monof., QPAR51

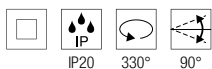
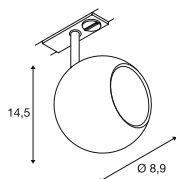

220-240V ~50/60Hz  
Material: aço



Casquilho: 1xGU10 máx. Ø: 5,1 cm | C: 5,4 cm

Versão	Art. n.º	EUR
● Preto	1008180	84,00
○ Branco	1008181	84,00



LED GU10 51 mm | 6W | 36°  
2200-2700K | 360lm | CEE=G  
6 kWh/1000h



Art. N.º: 1005273 | 9,99 EUR

1008180 576







LIGHT EYE® 150  
Monof., QPAR111

NEW

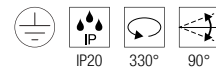
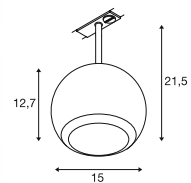

220-240V ~50/60Hz  
Material: aço

**SOCKET INSIDE** <math><12.5\text{ W}</math>

Casquilho: 1xGU10 máx. Ø: 11,1 cm | C: 7 cm

Versão	Art. n.º	EUR
● Preto	<b>1008182</b>	<b>132,00</b>
○ Branco	<b>1008183</b>	<b>132,00</b>



QPAR111 | 12W | 55°  
3000K | 680lm | CEE=G  
12 kWh/1000h



Art. N.º: **1005298** | **85,00 EUR**

1008168 549





**LIGHT EYE® 90**  
Monof., PD, QPAR51

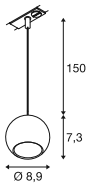

220-240V ~50/60Hz  
Material: aço



Casquilho: 1xGU10 máx. Ø: 5,1 cm | C: 5,35 cm

Versão	Art. n.º	EUR
● Preto	1008168	84,00
○ Branco	1008169	84,00



LED GU10 51 mm | 6W | 38°  
2700K | 450lm | CEE=F  
6 kWh/1000h



Art. N.º: 1005077 | 7,50 EUR

**LIGHT EYE® 150**  
Monof., PD, QPAR111

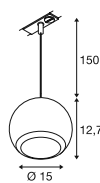

220-240V ~50/60Hz  
Material: aço



Casquilho: 1xGU10 máx. Ø: 11,1 cm | C: 7 cm

Versão	Art. n.º	EUR
● Preto	1008174	119,00
○ Branco	1008175	119,00



QPAR111 | 12W | 55°  
3000K | 680lm | CEE=G  
12 kWh/1000h



Art. N.º: 1005298 | 85,00 EUR

**LIGHT EYE® 90**  
Anel decorativo Ø 5,7 cm



Material: aço/aço  
A: 1,4 cm  
Ø: 5,9 cm

Versão	Art. n.º	EUR
● Preto	1008186	9,00
○ Branco	1008187	9,00
● Dourado	1008188	14,00

**LIGHT EYE® 150**  
Anel decorativo Ø 13,6 cm



Material: aço/aço  
A: 2,3 cm  
Ø: 13,6 cm

Versão	Art. n.º	EUR
● Preto	1008189	35,00
○ Branco	1008190	35,00
● Dourado	1008192	45,00
● Cromado	1008191	45,00





## KALU TRACK Monof., PHASE

## KALU TRACK Monof., QPAR111

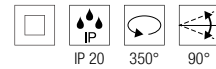
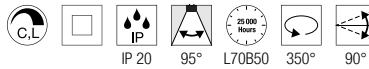
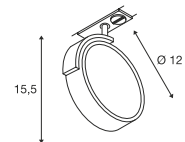
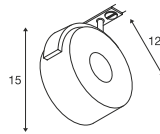

220-240V ~50/60Hz  
Potência do sistema: 13W  
Material: alumínio

220-240V ~50/60Hz  
Material: alumínio/plástico



Down 970lm | 3000K

Versão	Art. n.º	EUR
● Preto	1002854	206,00
○ Branco	143731	206,00



Casquilho: 1xGU10

Versão	Art. n.º	EUR
● Preto	143540	75,00
○ Branco	143541	75,00
● Cinzento	143544	75,00



QPAR111 | 12,5W | 10°  
3000K | 950lm | CEE=F  
13 kWh/1000h



Art. N.º: 1005278 | 55,00 EUR

**NOBLO SPOT**  
Monof., Triple Track Set

**NOBLO SPOT**  
Monof., PHASE

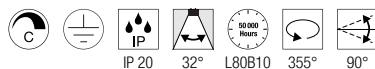
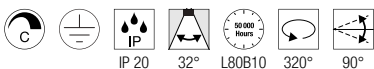
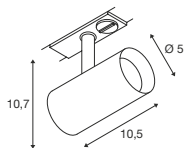
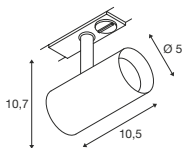
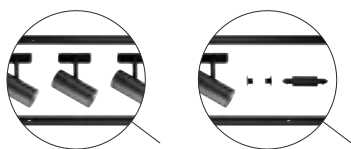

220-240V ~50/60Hz | 150mA  
Potência do sistema: 19W  
Material: alumínio

220-240V ~50/60Hz | 150mA  
Potência do sistema: 6W  
Material: alumínio/polycarbonato (PC)

- Consiste em 2 x 1 m de calha eletrificada, 1 x conector longitudinal com opção de alimentação, 1 x 2 tampas, 3 x projetores NOBLO



Down 2250lm | 2700K

Down 740lm | 2700K

Versão	Art. n.º	EUR
● Preto	1007673	255,00
○ Branco	1007674	255,00

Versão	Art. n.º	EUR
● Preto	1007638	70,00
○ Branco	1007639	70,00
● Cinzento	1007640	70,00



Artigo	Art. n.º	EUR
Anel decorativo		
● Preto	1008482	5,90
○ Branco	1008483	5,90
● Dourado	1008484	5,90
● Cinzento	1008485	5,90
● Cobre	1008486	5,90
● Bronze	1008487	5,90



Artigo	Art. n.º	EUR
Anel decorativo		
● Preto	1008482	5,90
○ Branco	1008483	5,90
● Dourado	1008484	5,90
● Cinzento	1008485	5,90
● Cobre	1008486	5,90
● Bronze	1008487	5,90



1007353 583



### NOBLO SPOT Monof., PHASE

### NOBLO SPOT Monof., PHASE

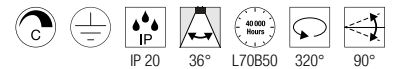
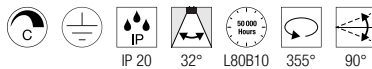
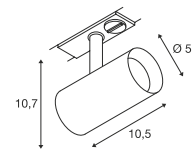
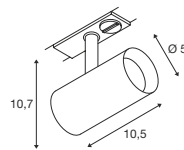

220-240V ~50/60Hz | 150mA  
Potência do sistema: 6W  
Material: alumínio/policarbonato (PC)

220-240V ~50/60Hz | 350mA  
Potência do sistema: 8,4W  
Material: alumínio/policarbonato (PC)



Down 750lm | 3000K

Down 30lm | 2000K - 450lm | 3000K

Versão	Art. n.º	EUR
● Preto	1007641	70,00
○ Branco	1007642	70,00
● Cinzento	1007643	70,00

Versão	Art. n.º	EUR
● Preto	1007352	85,00
○ Branco	1007353	85,00
● Cinzento	1007354	85,00



Artigo	Art. n.º	EUR
Anel decorativo		
● Preto	1008482	5,90
○ Branco	1008483	5,90
● Dourado	1008484	5,90
● Cinzento	1008485	5,90
● Cobre	1008486	5,90
● Bronze	1008487	5,90

Artigo	Art. n.º	EUR
Anel decorativo		
● Preto	1008482	5,90
○ Branco	1008483	5,90
● Dourado	1008484	5,90
● Cinzento	1008485	5,90
● Cobre	1008486	5,90
● Bronze	1008487	5,90

1006445 585







### ASTO TUBE Monof., GU10

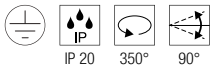
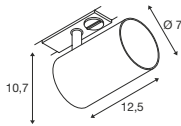

220-240V ~50/60Hz  
Material: alumínio



Casquilho: 1xGU10

Versão	Art. n.º	EUR
● Preto	1006445	70,00
○ Branco	1006446	70,00



LED GU10 51 mm | 6W | 38°  
2700K | 450lm | CEE=F  
6 kWh/1000h



Art. N.º: 1005077 | 7,50 EUR

### ASTO TUBE Refletor decorativo



A: 3,95 cm  
Ø: 6,75 cm  
Material: policarbonato (PC)

Versão	Art. n.º	EUR
● Cromado preto	1007190	4,00
● Dourado	1006450	4,00
● Cromado	1006449	4,00
● Cobre	1006451	4,00

### PANTILHO ROPE 19 PD, E27

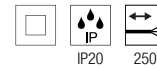
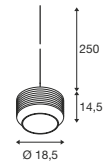

200-240V ~50/60Hz  
Material: vidro / aço / cânhamo

- Extremidade do cabo aberta



Casquilho: 1xE27

Máx. Ø: 10 cm

C: 11 cm

Versão	Art. n.º	EUR
● Âmbar/dourado	1007597	199,00
● Antracite/prateado	1007596	199,00



A60 | 7,5W | 180°  
2700K | 720lm | CEE=F  
8 kWh/1000h



Art. N.º: 1005305 | 19,00 EUR



1006155 587



1006160 587



PARA CONE GL  
Monof., GU10

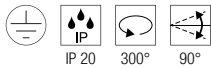
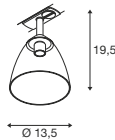

220-240V ~50/60Hz  
Material: alumínio/vidro



Casquilho: 1xGU10

Versão	Art. n.º	EUR
● Preto	1006155	89,00
○ Branco	1006156	89,00



LED GU10 51mm | 3,2W  
2700K | 270lm | EE=G



Art. N.º: 1006321 | 39,00 EUR

PARA CONE 14  
Monof., GU10

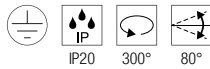
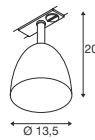

220-240V ~50/60Hz  
Material: aço



Casquilho: 1xGU10

Versão	Art. n.º	EUR
● Preto/dourado	1008052	86,00
○ Branco/dourado	1008053	86,00
● Cobre/branco	1008054	89,00



LED GU10 | 6,5W | 330°  
2700K | 650lm | CEE=F  
7 kWh/1000h



Art. N.º: 1008375 | 44,00 EUR

PARA CONE 14  
Monof., PD, GU10

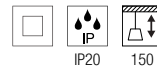
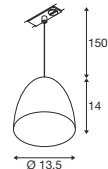

220-240V ~50/60Hz  
Material: aço



Casquilho: 1xGU10

Versão	Art. n.º	EUR
● Preto/dourado	1008058	117,00
○ Branco/dourado	1008059	117,00
● Cobre/branco	1008060	124,00



LED GU10 51 mm | 6W | 38°  
2700K | 450lm | CEE=F  
6 kWh/1000h



Art. N.º: 1005077 | 7,50 EUR

143580 589



1004934 589



1004935 589





### HELIA 50 TRACK Monof.

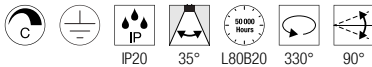
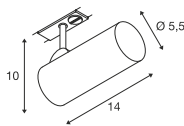

220-240V ~50/60Hz | 500  
Potência do sistema: 11W  
Material: alumínio



Down 810lm | 3000K  
880lm

Versão	Art. n.º	EUR
● Preto		
810lm	<b>143580</b>	<b>90,00</b>
○ Branco		
880lm	<b>143581</b>	<b>90,00</b>

### PANEL TRACK Monof., retangular

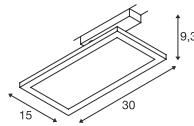

220-240V ~50/60Hz | 450mA  
Potência do sistema: 18W  
Material: policarbonato (PC)/aço



Down 1800lm | 3000K

Versão	Art. n.º	EUR
● Preto	<b>1004933</b>	<b>96,00</b>
○ Branco	<b>1004934</b>	<b>96,00</b>

### PANEL TRACK Monof., redondo

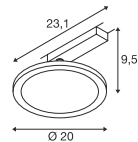

220-240V ~50/60Hz | 450mA  
Potência do sistema: 18W  
Material: policarbonato (PC)/aço



Down 1800lm | 3000K

Versão	Art. n.º	EUR
● Preto	<b>1004935</b>	<b>96,00</b>
○ Branco	<b>1004936</b>	<b>96,00</b>

1001868 594





### PURI TRACK Monof., Triple Track Set

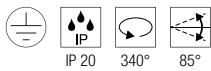
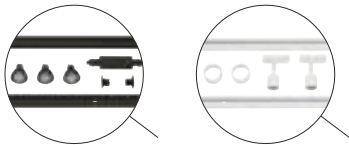

220-240V ~50/60Hz  
Potência do sistema: 4,3W  
Material: alumínio

- Constituído por calha eletrificada 2 x 1 m
- 1 Conector longitudinal com alimentação
- 1x 2 Tampas
- 3x Base do projetor PURI
- 3x GU10 2700K lâmpada
- 3x Anel decorativo para GU10

### PURI TRACK Monof., QPAR51

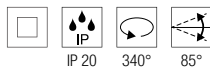
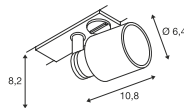

220-240V ~50/60Hz  
Material: alumínio/plástico



Casquilho: 1xGU10

Versão	Art. n.º	EUR
● Preto	1001868	45,00
○ Branco	1001869	45,00



LED GU10 51 mm | 6W | 36°  
2200-2700K | 360lm | CEE=G  
6 kWh/1000h



Art. N.º: 1005273 | 9,99 EUR

### PURI TRACK Monof., QPAR51

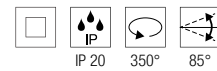
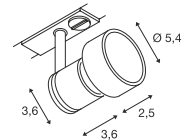

220-240V ~50/60Hz  
Material: alumínio/policarbonato (PC)

- Anel decorativo incl.



Casquilho: 1xGU10

Versão	Art. n.º	EUR
● Preto	143390	34,00
○ Branco	143391	34,00
● Cinzento	143392	34,00



LED GU10 51 mm | 6W | 38°  
2700K | 450lm | CEE=F  
6 kWh/1000h



Art. N.º: 1005077 | 7,50 EUR

TONGA®  
Monof., PD, E14

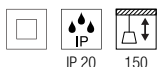
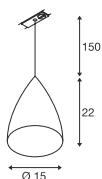

IP 20 150

220-240V ~50/60Hz  
Material: alumínio/vidro



Casquilho: 1xE14 máx. Ø: 5,1 cm | C: 13 cm

Versão	Art. n.º	EUR
● Cinzento/leitoso	143594	129,00



C35 | 4,2W | 320°  
2700K | 350lm | CEE=G  
5 kWh/1000h



Art. N.º: 1005285 | 8,50 EUR

143594 592







143450 593

### PURIA TRACK Monof., QPAR51

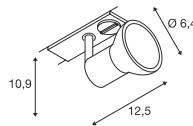

### AVO TRACK Monof., QPAR51

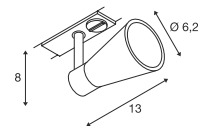

143451 593

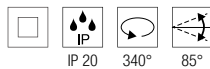

220-240V ~50/60Hz  
Material: alumínio/plástico

- Apenas compatível com a calha eletrificada saliente de 48V padrão



Casquilho: 1xGU10

Versão	Art. n.º	EUR
● Preto	143450	42,75
○ Branco	143451	42,75
● Cinzento	143454	42,75



LED GU10 51 mm | 6W | 36°  
2200-2700K | 360lm | CEE=G  
6 kWh/1000h



Art. N.º: 1005273 | 9,99 EUR

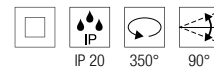

220-240V ~50/60Hz  
Material: aço

- Apenas compatível com a calha eletrificada saliente de 48V padrão



Casquilho: 1xGU10

máx. Ø: 5,1 cm

Versão	Art. n.º	EUR
● Preto	144200	38,50
○ Branco	144201	38,50
● Cinzento	144204	38,50



LED GU10 51 mm | 6W | 36°  
2200-2700K | 360lm | CEE=G  
6 kWh/1000h



Art. N.º: 1005273 | 9,99 EUR

ENOLA C TRACK  
Monof.

ENOLA C TRACK  
Monof.

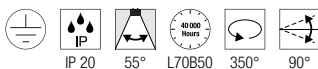
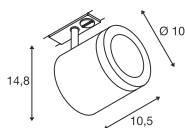
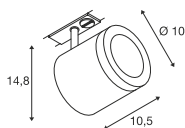

220-240V ~50/60Hz | 500mA  
Potência do sistema: 11W  
Material: alumínio/vidro

220-240V ~50/60Hz | 500mA  
Potência do sistema: 11W  
Material: alumínio/vidro



Down 1040lm | 3000K



Down 1040lm | 3000K

Versão	Art. n.º	EUR
● Preto	1000711	177,00
○ Branco	143941	177,00

Versão	Art. n.º	EUR
● Preto	1000712	177,00
○ Branco	143951	177,00





**ENOLA B TRACK**  
Monof., QPAR51

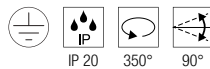
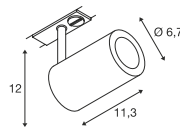

220-240V ~50/60Hz  
Material: alumínio/aço



Casquilho: 1xGU10 máx. Ø: 5,1 cm C: 6,7 cm

Versão	Art. n.º	EUR
● Preto	1002110	70,00
○ Branco	1002111	70,00
● Cinzento	1002113	70,00



LED GU10 51 mm | 6W | 38°  
2700K | 450lm | CEE=F  
6 kWh/1000h



Art. N.º: 1005075 | 7,50 EUR

**ENOLA B**  
Monof., PD, QPAR51

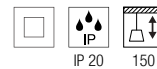
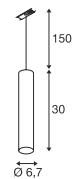

220-240V ~50/60Hz  
Material: alumínio/aço



Casquilho: 1xGU10

Versão	Art. n.º	EUR
● Preto	143960	125,00
○ Branco	143961	125,00



LED GU10 51 mm | 6W | 36°  
2200-2700K | 360lm | CEE=G  
6 kWh/1000h



Art. N.º: 1005273 | 9,99 EUR



143960 495





143430 597



**BIMA**  
Monof., single, QPAR51

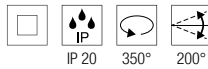
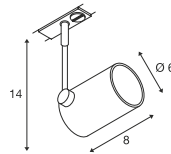

220-240V ~50/60Hz  
Material: alumínio



Casquilho: 1xGU10 máx. Ø: 5,1 cm | C: 5,7 cm

Versão	Art. n.º	EUR
● Preto	143440	45,00
○ Branco	143441	45,00
● Cinzento	143442	45,00



LED GU10 51 mm | 6W | 38°  
2700K | 450lm | CEE=F  
6 kWh/1000h



Art. N.º: 1005077 | 7,50 EUR

**BIMA**  
Monof., double, QPAR51

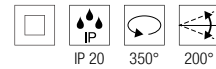
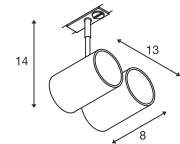

220-240V ~50/60Hz  
Material: alumínio



Casquilho: 2xGU10 máx. Ø: 5,1 cm | C: 5,7 cm

Versão	Art. n.º	EUR
● Preto	143430	70,00
○ Branco	143431	70,00
● Cinzento	143432	70,00



LED GU10 51 mm | 6W | 36°  
2200-2700K | 360lm | CEE=G  
6 kWh/1000h



Art. N.º: 1005273 | 9,99 EUR

# EURO SPOT TRACK

Monof., QPAR51

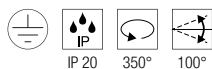
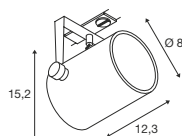

220-240V ~50/60Hz  
Material: alumínio



Casquilho: 1xGU10

Versão	Art. n.º	EUR
● Preto	1001861	77,00
○ Branco	143811	77,00



LED GU10 51 mm | 6W | 36°  
2200-2700K | 360lm | CEE=G  
6 kWh/1000h



Art. N.º: 1005273 | 9,99 EUR

1001861 598





## ALTRA DICE TRACK Monof., QPAR51

143350 599

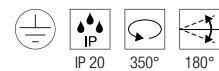
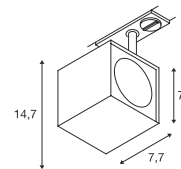

220-240V ~50/60Hz  
Material: alumínio

**SOCKET** **INSIDE** <50  
W

Casquilho: 1xGU10

Versão	Art. n.º	EUR
● Preto	143350	85,00
○ Branco	143351	85,00



LED GU10 51 mm | 6W | 38°  
3000K | 470lm | CEE=F  
6 kWh/1000h



Art. N.º: 1005080 | 7,50 EUR



**SCKET**  
PURI 2.0 | 619



**SCKET**  
PURI 2.0 | 619



**SCKET**  
PURI 2.0 | 619



**SCKET**  
PURI 2.0 | 621



**SCKET**  
PURI 2.0 | 621



**SCKET**  
PURI 2.0 | 621



**SCKET**  
PURI 2.0 | 622



**SCKET**  
PURI 2.0 | 623



**PURI 2.0 | 623**



**PURI 2.0 | 623**



**PURI 2.0 | 623**



**LED**  
GRIP! M | 624



**LED**  
GRIP! M | 624



**LED**  
GRIP! M | 625



**LED**  
GRIP! M | 625



**SCKET**  
GRIP! L | 627



**LED**  
NUMINOS® S | 628



**LED**  
NUMINOS® M | 630



**LED**  
NUMINOS® L | 632



**LED**  
NUMINOS® XL | 634



**LED**  
NUMINOS® ZOOM M | 636



**LED**  
ONE 40 TRACK | 643



**LED**  
NOBLO SPOT | 644



**LED**  
NOBLO SPOT | 644



**LED**  
NOBLO SPOT | 645



**LED**  
NOBLO SPOT | 645



**LED**  
SIGHT EASY | 647

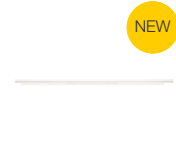

**LED**  
SIGHT EASY | 647



**LED**  
SIGHT TRACK | 648



**LED**  
SIGHT TRACK | 648



**LED**  
SIGHT MOVE | 649



**LED**  
SIGHT MOVE | 649



**SCKET**  
PARA CONE 14 | 651



**SCKET**  
PARA CONE 14 | 651



**SCKET**  
PARA CONE GL | 653



**SCKET**  
PARA CONE GL | 653



**SCKET**  
FORCHINI M  
40 TRACK | 655



**SCKET**  
LIGHT EYE® 90 | 656



**SCKET**  
LIGHT EYE® 150 | 657



**SCKET**  
LIGHT EYE® 150 | 657



**SCKET**  
ALTRA DICE  
TRACK | 658



**LED**  
EURO CUBE | 658





**S**CKET

EURO SPOT  
TRACK | 659



**S**CKET

EURO SPOT  
TRACK | 659



**S**CKET

PURI TRACK | 661



**S**CKET

PURI TRACK | 661



**LED**

KALU TRACK | 662



**S**CKET

KALU TRACK | 662



**S**CKET

BIMA | 663



**S**CKET

BIMA | 663



**LED**

HELIA 50 TRACK | 665



**LED**

ENOLA C TRACK | 665





**S**CKET



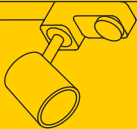
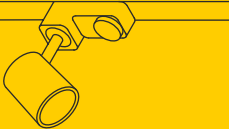

AVO TRACK | 665

# COMPATIBILIDADE DAS CALHAS ELETRIFICADAS TRIFÁSICAS

Compatibilidade das calhas com adaptadores de:

	SLV	EUTRAC®	Global/Nordic
SLV Calhas eletrificadas e componentes de calhas eletrificadas S-Track 			
Trifásicas	✓	✓	✓
DALI trifásico	✓	✗	✓

Compatibilidade da luminária com calhas eletrificadas e componentes de calhas eletrificadas de:

	SLV S-TRACK	EUTRAC®	Global/Nordic
SLV Adaptadores trifásicos de luminárias 			
Trifásicas	✓	✓	✓
DALI trifásico	✓	✗	✓

Os sistemas e componentes de calhas eletrificadas SLV são altamente compatíveis. Com luminárias e adaptadores: EUTRAC®, Zumtobel, Erco, LTS ONETrack e unipro®.

Zumtobel	Erco	LTS ONETrack	unipro®
			
✓	✓	✓	✓
✗	✗	✓	✓
Zumtobel	Erco	LTS ONETrack	unipro®
			
✓	✓	✓	✓
✗	✗	✓	✓

Informações fornecidas sem garantia.

Os dados técnicos e as dimensões estão sujeitos a alterações a qualquer momento e sem aviso prévio.

Verificar com a amostra logo durante o planeamento do projeto, para garantir a funcionalidade.

Compatibilidade refere-se apenas a calhas eletrificadas/luminárias.

Calhas eletrificadas e componentes de calhas eletrificadas de diferentes fabricantes não devem ser combinados.

Sujeito a testes anteriores com amostras das luminárias e das calhas eletrificadas.

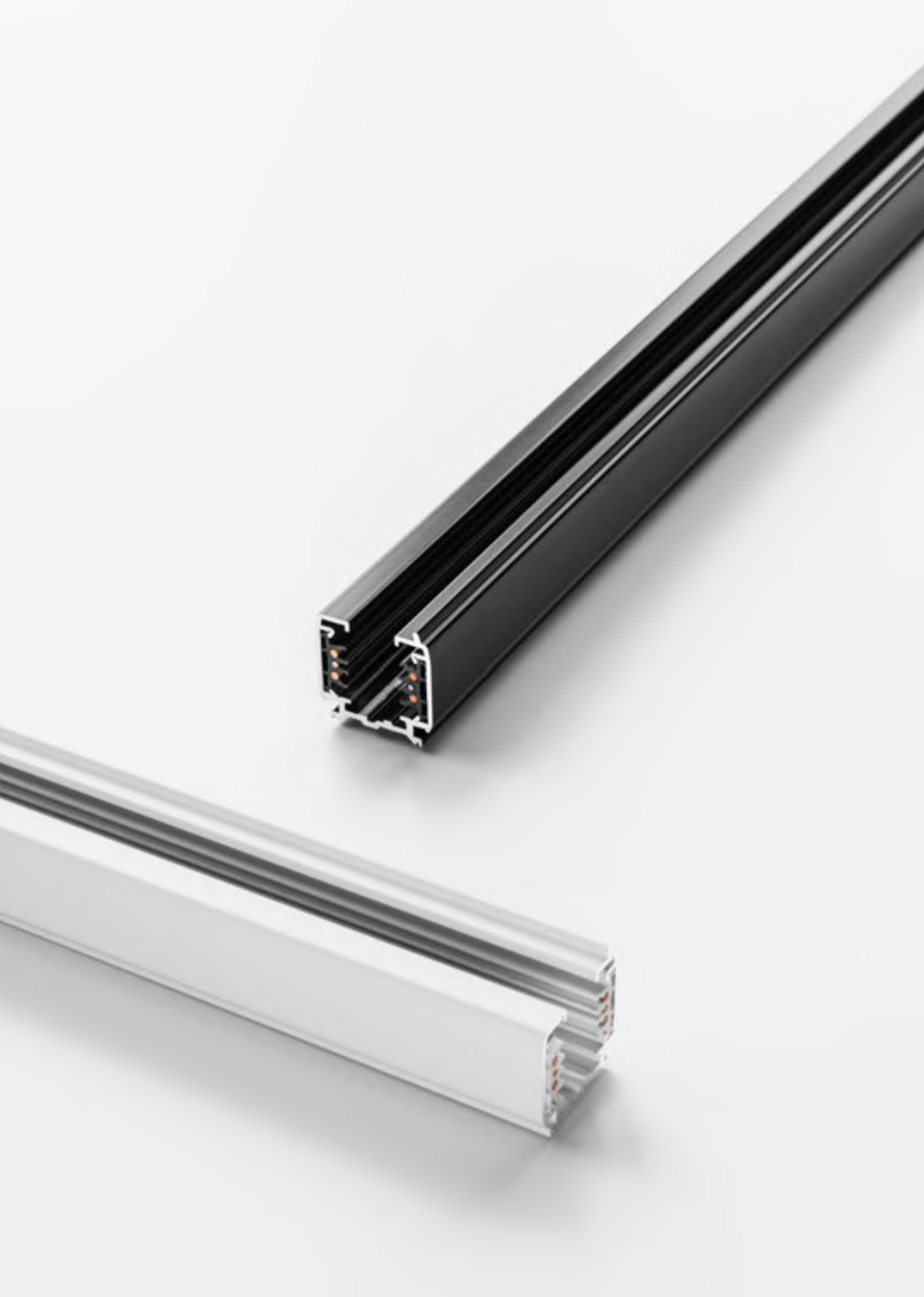



## S-TRACK

DALI Calha eletrificada saliente trifásica



	1 m	1 m	2 m	2 m
Tensão nominal (V)	220-250V ~50/60Hz	220-250V ~50/60Hz	220-250V ~50/60Hz	220-250V ~50/60Hz
Intensidade máx. de corrente (A)	16	16	16	16
Carga mec. máx.	30 kg	30 kg	30 kg	30 kg
Cor	● Preto	○ Branco	● Preto	○ Branco
Material	Alumínio	Alumínio	Alumínio	Alumínio
C x L x A (cm)	100 x 3,6 x 3,6	100 x 3,6 x 3,6	200 x 3,6 x 3,6	200 x 3,6 x 3,6
Art. n.º	1004937	1004938	1002631	1002632
EUR	45,50	45,50	81,00	81,00

	3 m	3 m	4 m	4 m
Tensão nominal (V)	220-250V ~50/60Hz	220-250V ~50/60Hz	220-250V ~50/60Hz	220-250V ~50/60Hz
Intensidade máx. de corrente (A)	16	16	16	16
Carga mec. máx.	30 kg	30 kg	30 kg	30 kg
Cor	● Preto	○ Branco	● Preto	○ Branco
Material	Alumínio	Alumínio	Alumínio	Alumínio
C x L x A (cm)	300 x 3,6 x 3,6	300 x 3,6 x 3,6	400 x 3,6 x 3,6	400 x 3,6 x 3,6
Art. n.º	1002633	1002634	1002635	1002636
EUR	117,00	117,00	147,00	147,00

# S-TRACK

DALI Calha eletrificada saliente trifásica  
 Guia de planeamento e acessórios em resumo

Vista de cima dos componentes  
 no lado da montagem

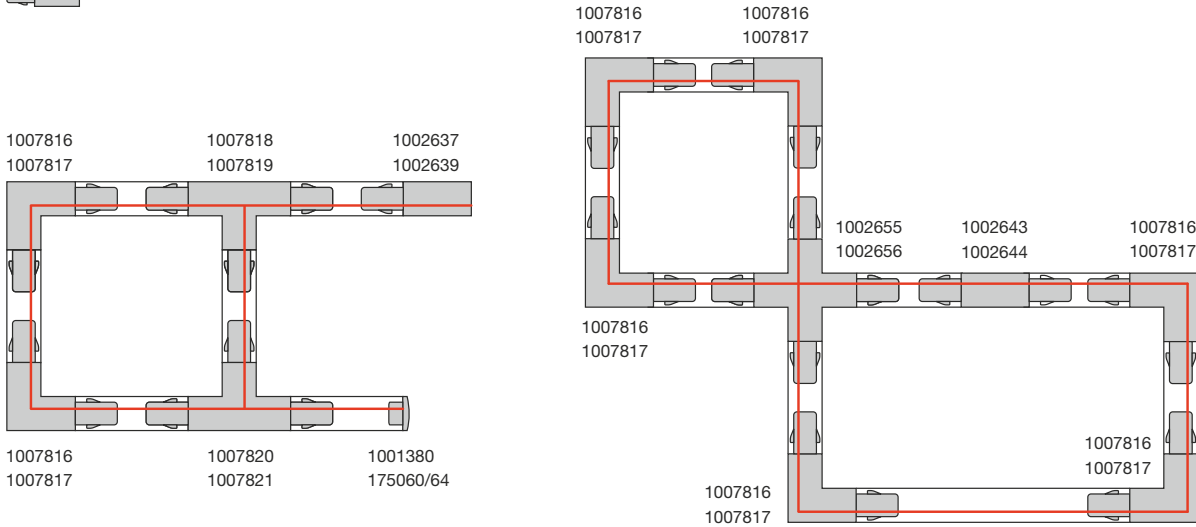
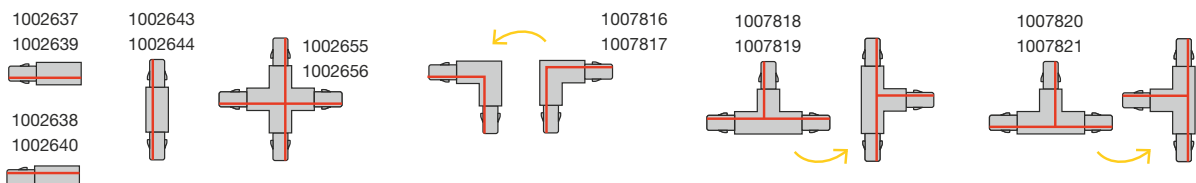
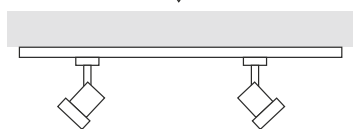

**Conector em T, PHASE & DALI,  
 regulável, esquerdo**  
 16 A máx. | Policarbonato (PC)  
 C: 20,3 cm | L: 11,9 cm | A: 3,3 cm

- Preto      Art. n.º **1007818** ● **39,00 EUR**
- Branco     **1007819** ● **39,00 EUR**



**Conector em T, PHASE & DALI,  
 regulável, direito**  
 16 A máx. | Policarbonato (PC)  
 C: 20,3 cm | L: 11,9 cm | A: 3,3 cm

- Preto      Art. n.º **1007820** ● **39,00 EUR**
- Branco     **1007821** ● **39,00 EUR**

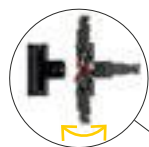



**Conector em L, PHASE & DALI, regulável**

16 A máx. | Policarbonato (PC)  
C: 11,9 cm | L: 11,9 cm | A: 3,3 cm

- Preto Art. n.º 1007816 ● 33,00 EUR
- Branco Art. n.º 1007817 ● 33,00 EUR



**Alimentador, DALI, terra esquerda**

16 A máx. | Policarbonato (PC)  
C: 13,9 cm | L: 3,5 cm | A: 3,3 cm

- Preto Art. n.º 1002637 19,00 EUR
- Branco Art. n.º 1002639 19,00 EUR

**Alimentador, DALI, terra direita**

16 A máx. | Policarbonato (PC)  
C: 13,9 cm | L: 3,5 cm | A: 3,3 cm

- Preto Art. n.º 1002638 19,00 EUR
- Branco Art. n.º 1002640 19,00 EUR



**Conector em X, DALI\***

16 A máx. | Policarbonato (PC)  
C: 20,3 cm | L: 20,3 cm | A: 3,3 cm

- Preto Art. n.º 1002655 63,00 EUR
- Branco Art. n.º 1002656 63,00 EUR

**Conector longitudinal, DALI\***

16 A máx. | Policarbonato (PC)  
C: 20,3 cm | L: 3,5 cm | A: 3,3 cm

- Preto Art. n.º 1002643 33,25 EUR
- Branco Art. n.º 1002644 33,25 EUR



**Conector isolante**

Plástico  
C: 6,8 cm | L: 3,1 cm | A: 2,6 cm

- Preto Art. n.º 175080 7,65 EUR
- Branco Art. n.º 1001382 7,65 EUR

**Conector flexível, DALI**

16 A máx. | Policarbonato (PC)  
C: 28,5 cm | L: 3,5 cm | A: 3,3 cm

- Preto Art. n.º 1002645 54,00 EUR
- Branco Art. n.º 1002646 54,00 EUR



**Miniconector, DALI**

16 A máx. | Policarbonato (PC)  
C: 10,6 cm | L: 2,5 cm | A: 2,8 cm

- Preto Art. n.º 1002641 10,10 EUR
- Branco Art. n.º 1002642 10,10 EUR

**Acessório de suspensão, DALI**

Aço  
C: 4 cm | L: 3,4 cm | A: 1,25 cm

- Preto Art. n.º 1002657 7,65 EUR
- Branco Art. n.º 1002658 7,65 EUR



**Adaptador trif., Dali**

10 A máx. | 5 kg máx. | Policarbonato (PC)  
C: 11,3 cm | L: 5,5 cm | A: 3,3 cm

- Preto Art. n.º 1002660 18,70 EUR
- Branco Art. n.º 1002659 18,70 EUR

**Adaptador Adaptador mec.**

5 kg máx. | Alumínio/plástico  
C: 6,6 cm | L: 6,6 cm | A: 3,1 cm

- Preto Art. n.º 175210 15,40 EUR
- Branco Art. n.º 1001395 15,40 EUR



**Cobertura, 2 m**

Policarbonato (PC)  
C: 200 cm | L: 2,2 cm | A: 0,75 cm

- Preto Art. n.º 1004939 7,55 EUR
- Branco Art. n.º 1004940 7,55 EUR

**Tampa**

Plástico  
C: 3,5 cm | L: 3,3 cm | A: 3,2 cm

- Preto Art. n.º 175060 2,00 EUR
- Branco Art. n.º 1001380 2,00 EUR



**Estrutura suspensa**

Alumínio/plástico  
C: 6 cm | L: 6 cm | A: 4 cm

- Preto Art. n.º 175160 32,50 EUR
- Branco Art. n.º 1001390 32,50 EUR



**Conector de calha eletrificada**

Alumínio  
C: 18,2 cm | L: 3,3 cm | A: 2,1 cm

- Preto Art. n.º 175180 11,90 EUR
- Branco Art. n.º 1001392 11,90 EUR



**Adaptador Adaptador Adaptador com gancho**

5 kg máx. | Plástico/Aço  
A: 5,2 cm

- Preto Art. n.º 175190 2,70 EUR
- Branco Art. n.º 1001393 2,70 EUR

**Roseta para teto, DALI**

16 A máx. | Policarbonato (PC)  
A: 3,5 cm | Ø: 14,3 cm

- Preto Art. n.º 1004684 37,75 EUR
- Branco Art. n.º 1004685 37,75 EUR



**Suspensão de cabos de aço (2 un.)**

5 kg máx. | Aço inoxidável/latão  
C: 500 cm

- Níquel Art. n.º 1002845 41,75 EUR







## S-TRACK

Calha eletrificada de montagem encastrada trifásica, DALI



	1 m	1 m	2 m	2 m
Tensão nominal (V)	220-250V ~50/60Hz	220-250V ~50/60Hz	220-250V ~50/60Hz	220-250V ~50/60Hz
Intensidade máx. de corrente (A)	16	16	16	16
Carga mec. máx.	30 kg	30 kg	30 kg	30 kg
Cor	● Preto	○ Branco	● Preto	○ Branco
Material	Alumínio	Alumínio	Alumínio	Alumínio
C x L x A (cm)	100 x 5,6 x 3,2	100 x 5,6 x 3,2	200 x 5,6 x 3,2	200 x 5,6 x 3,2
Art. n.º	1006511	1006512	1006513	1006514
EUR	53,00	53,00	96,00	96,00

	3 m	3 m	4 m	4 m
Tensão nominal (V)	220-250V ~50/60Hz	220-250V ~50/60Hz	220-250V ~50/60Hz	220-250V ~50/60Hz
Intensidade máx. de corrente (A)	16	16	16	16
Carga mec. máx.	30 kg	30 kg	30 kg	30 kg
Cor	● Preto	○ Branco	● Preto	○ Branco
Material	Alumínio	Alumínio	Alumínio	Alumínio
C x L x A (cm)	300 x 5,6 x 3,2	300 x 5,6 x 3,2	400 x 5,6 x 3,2	400 x 5,6 x 3,2
Art. n.º	1006515	1006516	1006517	1006518
EUR	137,00	137,00	217,00	217,00

# S-TRACK

DALI Calha eletrificada de montagem encastrada trifásica:  
 guia de planeamento e acessórios em resumo

Vista de cima dos componentes  
 no lado da montagem

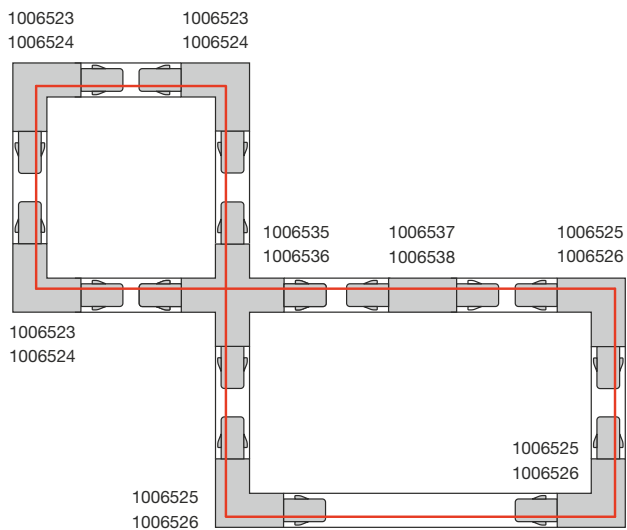
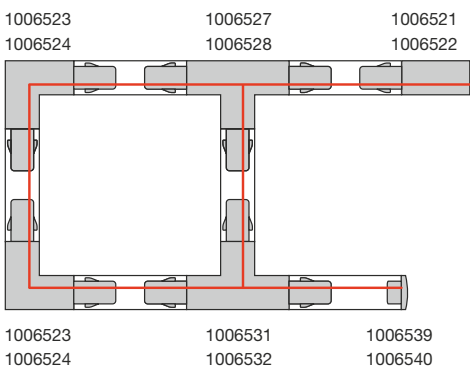
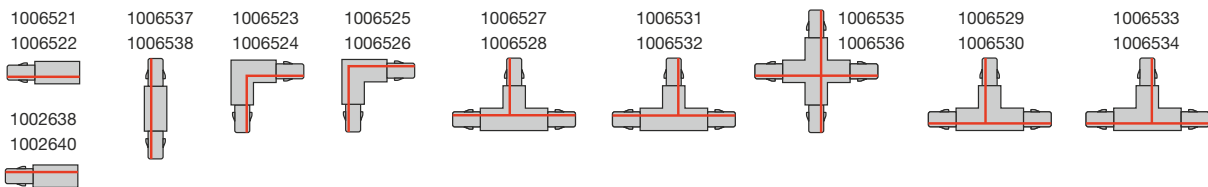
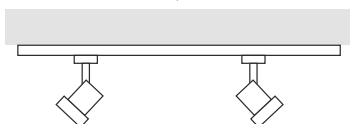

**Alimentador, DALI, terra esquerda**

16 A máx. | Policarbonato (PC)  
C: 14,7 cm | L: 5,6 cm | A: 3,3 cm

- Preto Art. n.º **1006521** **25,00 EUR**
- Branco Art. n.º **1006522** **25,00 EUR**

**Alimentador, DALI, terra direita**

16 A máx. | Policarbonato (PC)  
C: 14,7 cm | L: 5,6 cm | A: 3,3 cm

- Preto Art. n.º **1006519** **25,00 EUR**
- Branco Art. n.º **1006520** **25,00 EUR**

**Conector em L, DALI, terra interior\***

16 A máx. | Policarbonato (PC)  
C: 13 cm | L: 13 cm | A: 3,3 cm

- Preto Art. n.º **1006523** **33,25 EUR**
- Branco Art. n.º **1006524** **33,25 EUR**

**Conector em L, DALI, terra exterior\***

16 A máx. | Policarbonato (PC)  
C: 13 cm | L: 13 cm | A: 3,3 cm

- Preto Art. n.º **1006525** **33,25 EUR**
- Branco Art. n.º **1006526** **33,25 EUR**

**Conector em T, DALI, terra exterior, esquerda\***

16 A máx. | Policarbonato (PC)  
C: 20,3 cm | L: 13 cm | A: 3,3 cm

- Preto Art. n.º **1006529** **39,00 EUR**
- Branco Art. n.º **1006530** **39,00 EUR**

**Conector em T, DALI, terra interior, direita\***

16 A máx. | Policarbonato (PC)  
C: 20,3 cm | L: 13 cm | A: 3,3 cm

- Preto Art. n.º **1006531** **39,00 EUR**
- Branco Art. n.º **1006532** **39,00 EUR**

**Conector em T, DALI, terra interior, esquerda\***

16 A máx. | Policarbonato (PC)  
C: 20,3 cm | L: 13 cm | A: 3,3 cm

- Preto Art. n.º **1006527** **39,00 EUR**
- Branco Art. n.º **1006528** **39,00 EUR**

**Conector em T, DALI, terra exterior, direita\***

16 A máx. | Policarbonato (PC)  
C: 20,3 cm | L: 13 cm | A: 3,3 cm

- Preto Art. n.º **1006533** **39,00 EUR**
- Branco Art. n.º **1006534** **39,00 EUR**

**Conector em X, DALI\***

16 A máx. | Policarbonato (PC)  
C: 20,3 cm | L: 20,3 cm | A: 3,3 cm

- Preto Art. n.º **1006535** **63,00 EUR**
- Branco Art. n.º **1006536** **63,00 EUR**

**Conector longitudinal, DALI\***

16 A máx. | Policarbonato (PC)  
C: 20,3 cm | L: 5,6 cm | A: 3,3 cm

- Preto Art. n.º **1006537** **33,25 EUR**
- Branco Art. n.º **1006538** **33,25 EUR**

**Miniconector, DALI**

16 A máx. | Policarbonato (PC)  
C: 10,6 cm | L: 2,5 cm | A: 2,8 cm

- Preto Art. n.º **1002641** **10,10 EUR**
- Branco Art. n.º **1002642** **10,10 EUR**

**Tampa para calha eletrificada de montagem encastrada trifásica, DALI**

Policarbonato (PC)  
C: 4,79 cm | L: 5,6 cm

- Preto Art. n.º **1006539** **2,00 EUR**
- Branco Art. n.º **1006540** **2,00 EUR**

**Adaptador Adaptador, DALI**

10 A máx. | **5 kg** máx. | Policarbonato (PC)  
C: 11,3 cm | L: 5,5 cm | A: 3,3 cm

- Preto Art. n.º **1002660** **18,70 EUR**
- Branco Art. n.º **1002659** **18,70 EUR**





## EUTRAC®

Calha eletrificada saliente trifásica



	<b>1 m</b>	<b>1 m</b>	<b>1 m</b>
Tensão nominal (V)	220-240V ~50/60Hz	220-240V ~50/60Hz	220-240V ~50/60Hz
Intensidade máx. de corrente (A)	16	16	16
Cor	● Preto	○ Branco	● Cinzento
Material	Alumínio/plástico	Alumínio/plástico	Alumínio/plástico
C x L x A (cm)	100 x 3,6 x 3,2	100 x 3,6 x 3,2	100 x 3,6 x 3,2
Art. n.º	<b>145100</b>	<b>1001510</b>	<b>145102</b>
EUR	<b>49,50</b>	<b>49,50</b>	<b>49,50</b>
	<b>2 m</b>	<b>2 m</b>	<b>2 m</b>
Tensão nominal (V)	220-240V ~50/60Hz	220-240V ~50/60Hz	220-240V ~50/60Hz
Intensidade máx. de corrente (A)	16	16	16
Cor	● Preto	○ Branco	● Cinzento
Material	Alumínio/plástico	Alumínio/plástico	Alumínio/plástico
C x L x A (cm)	200 x 3,6 x 3,2	200 x 3,6 x 3,2	200 x 3,6 x 3,2
Art. n.º	<b>145200</b>	<b>1001511</b>	<b>145202</b>
EUR	<b>90,00</b>	<b>90,00</b>	<b>90,00</b>
	<b>3 m</b>	<b>3 m</b>	<b>3 m</b>
Tensão nominal (V)	220-240V ~50/60Hz	220-240V ~50/60Hz	220-240V ~50/60Hz
Intensidade máx. de corrente (A)	16	16	16
Cor	● Preto	○ Branco	● Cinzento
Material	Alumínio/plástico	Alumínio/plástico	Alumínio/plástico
C x L x A (cm)	300 x 3,6 x 3,2	300 x 3,6 x 3,2	300 x 3,6 x 3,2
Art. n.º	<b>145300</b>	<b>1001512</b>	<b>145302</b>
EUR	<b>141,00</b>	<b>141,00</b>	<b>141,00</b>

Calha eletrificada saliente trifásica:  
 guia de planeamento e acessórios em resumo

Vista de cima dos componentes  
 no lado da montagem

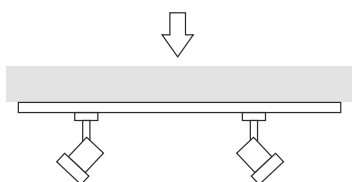

145510  
 1001513  
 145514



145520  
 1001514  
 145524



145670  
 1001520  
 145674



145680  
 1001521  
 145684



145630  
 1001518  
 145634

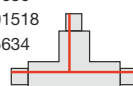

145640  
 1001519  
 145644

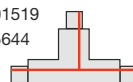

145690  
 1001522  
 145694

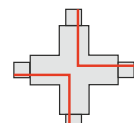

Exemplo: terra exterior

145670  
 1001520  
 145674

145510  
 1001513  
 145514

145670  
 1001520  
 145674

145680  
 1001521  
 145684

145520  
 1001514  
 145524

Exemplo: terra interior

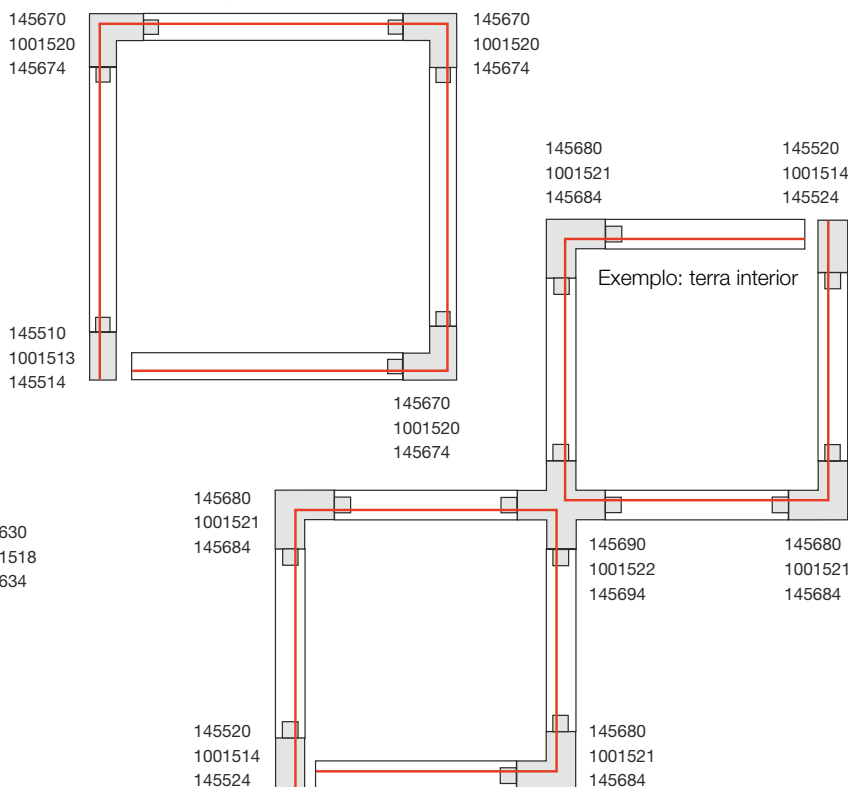
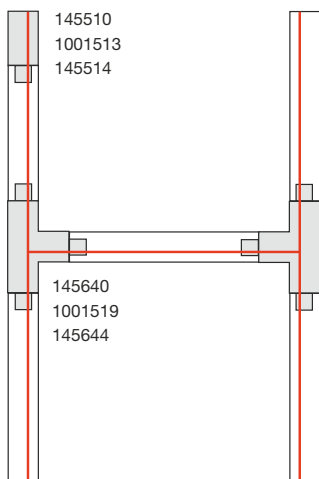



**Alimentador, terra esquerda**

16 A máx. | Plástico  
C: 11,2 cm | L: 3,6 cm | A: 3,2 cm



- Preto Art. n.º 145510 19,70 EUR
- Branco 1001513 19,70 EUR
- Cinzento 145514 19,70 EUR

**Alimentador, terra direita**

16 A máx. | Plástico  
C: 11,2 cm | L: 3,6 cm | A: 3,2 cm



- Preto Art. n.º 145520 19,70 EUR
- Branco 1001514 19,70 EUR
- Cinzento 145524 19,70 EUR

**Alimentador intermédio**

16 A máx. | Plástico  
C: 13 cm | L: 3,6 cm | A: 3,6 cm



- Preto Art. n.º 145530 44,75 EUR
- Branco 1001515 44,75 EUR
- Cinzento 145534 44,75 EUR

**Conector longitudinal\***

16 A máx. | Plástico  
C: 19,2 cm | L: 3,6 cm | A: 3,2 cm



- Preto Art. n.º 145660 78,00 EUR
- Branco 1001517 78,00 EUR
- Cinzento 145664 78,00 EUR

**Conector longitudinal\***

16 A máx. | Plástico  
C: 5,8 cm | L: 1,5 cm | A: 2,6 cm



- Preto Art. n.º 145560 19,70 EUR
- Branco 1001516 19,70 EUR
- Cinzento 145564 19,70 EUR

**Conector em L, terra interior\***

16 A máx. | Plástico  
C: 15 cm | L: 15 cm | A: 3,2 cm



- Preto Art. n.º 145680 65,00 EUR
- Branco 1001521 65,00 EUR
- Cinzento 145684 65,00 EUR

**Conector em L, terra exterior\***

16 A máx. | Plástico  
C: 15 cm | L: 15 cm | A: 3,2 cm



- Preto Art. n.º 145670 65,00 EUR
- Branco 1001520 65,00 EUR
- Cinzento 145674 65,00 EUR

**Conector em T, terra interior, esquerda\***

16 A máx. | Plástico  
C: 26 cm | L: 18,5 cm | A: 3,2 cm



- Preto Art. n.º 145630 89,00 EUR
- Branco 1001518 89,00 EUR
- Cinzento 145634 89,00 EUR

**Conector em T, terra interior, direita\***

16 A máx. | Plástico  
C: 26 cm | L: 18,5 cm | A: 3,2 cm



- Preto Art. n.º 145640 89,00 EUR
- Branco 1001519 89,00 EUR
- Cinzento 145644 89,00 EUR

**Conector em X\***

16 A máx. | Plástico  
C: 26 cm | L: 26 cm | A: 3,2 cm  
Dois circuitos de corrente separados



- Preto Art. n.º 145690 130,00 EUR
- Branco 1001522 130,00 EUR
- Cinzento 145694 130,00 EUR

**Conector de calha eletrificada**

Plástico  
C: 10 cm | L: 3,6 cm | A: 1,9 cm



- Preto Art. n.º 145600 21,75 EUR
- Branco 1001523 21,75 EUR
- Cinzento 145604 21,75 EUR

**Conector flex.**

16 A máx. | Plástico  
C: 30,7 cm | L: 3,6 cm | A: 3,2 cm



- Preto Art. n.º 145580 89,00 EUR
- Branco 1001524 89,00 EUR
- Cinzento 145584 89,00 EUR

**Tomada**

6,3 A máx. | Plástico  
C: 9,6 cm | L: 6,5 cm | A: 9 cm



- Preto Art. n.º 145700 94,00 EUR
- Branco 1001525 94,00 EUR

**Trifásica**

10 A máx. | 5 kg máx. | Plástico  
C: 9,6 cm | L: 3,5 cm | A: 4,5 cm



- Preto Art. n.º 145990 19,70 EUR
- Branco 1001542 19,70 EUR
- Cinzento 145994 19,70 EUR

**Acessório de suspensão**

Alumínio  
C: 5 cm | L: 3,6 cm | A: 1,9 cm



- Preto Art. n.º 145730 11,40 EUR
- Branco 1001530 11,40 EUR
- Cinzento 145734 11,40 EUR

**Adaptador individual para montagem saliente**

16 A máx. | Plástico  
A: 3,1 cm | Ø: 11,9 cm



- Preto Art. n.º 145830 104,00 EUR
- Branco 1001526 104,00 EUR
- Cinzento 145834 104,00 EUR

**Tampa**

Plástico  
C: 3,6 cm | L: 1,7 cm | A: 3,2 cm



- Preto Art. n.º 145590 4,00 EUR
- Branco 1001527 4,00 EUR
- Cinzento 145594 4,00 EUR

**Estrutura suspensa, fixa**

Plástico/aço  
A: 60 cm | Ø: 7 cm



- Preto Art. n.º 145720 39,00 EUR
- Branco 1001529 39,00 EUR
- Cinzento 145724 39,00 EUR

**Estrutura suspensa, fixa**

Plástico/aço  
A: 122 cm | Ø: 7 cm

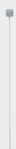

- Preto Art. n.º 145710 44,75 EUR
- Branco 1001528 44,75 EUR
- Cinzento 145714 44,75 EUR



**Suspensão de cabos de aço (2 un.)**

5 kg máx. | Aço inoxidável/latão  
C: 500 cm

- Níquel Art. n.º 1002845 41,75 EUR







# EUTRAC®

Calha eletrificada de montagem encastrada trifásica

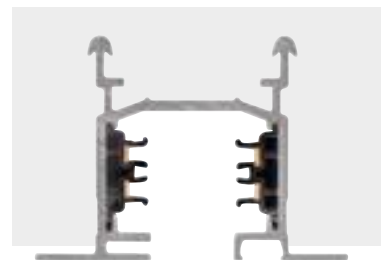

	2 m	3 m
Tensão nominal (V)	220-240V ~50/60Hz	220-240V ~50/60Hz
Intensidade máx. de corrente (A)	16	16
Cor	<input type="radio"/> Branco	<input type="radio"/> Branco
Material	Alumínio/plástico	Alumínio/plástico
C x L x A (cm)	200 x 5,9 x 4,1	300 x 5,9 x 4,1
Art. n.º	1001531	1001532
EUR	121,00	201,00



**Alimentador, terra esquerda**  
16 A máx. | Plástico/Aço  
C: 12,2 cm | L: 6 cm | A: 3,4 cm

Branco Art. n.º 1001533 32,50 EUR



**Alimentador, terra direita**  
16 A máx. | Plástico/Aço  
C: 12,2 cm | L: 6 cm | A: 3,4 cm

Branco Art. n.º 1001534 32,50 EUR



**Conector em L**  
16 A máx. | Plástico/Aço  
C: 16 cm | L: 16 cm | A: 3,2 cm  
Terra exterior. Com opção de alimentação

Branco Art. n.º 1001536 78,00 EUR



**Conector em L**  
16 A máx. | Plástico/Aço  
C: 16 cm | L: 16 cm | A: 3,2 cm  
Terra interior. Com opção de alimentação

Branco Art. n.º 1001537 78,00 EUR



**Tampa**  
Plástico  
C: 2,7 cm | L: 6 cm | A: 3,2 cm

Branco Art. n.º 1001538 7,65 EUR



**Conector longitudinal incl. estabilizador**  
16 A máx. | Plástico/Aço  
C: 6,2 cm | L: 2,5 cm | A: 2,7 cm

Branco Art. n.º 1001539 27,25 EUR



**Montagem da mola de montagem**  
Aço  
C: 2 cm | L: 1 cm | A: 2,5 cm

Cinzento Art. n.º 145551 13,20 EUR



**Adaptador da calha eletrificada trif.**  
16 A máx. | 5 kg máx. | Plástico  
C: 9,6 cm | L: 3,5 cm | A: 4,5 cm

Branco Art. n.º 1001542 19,70 EUR

1008271 619





PURI 2.0  
Tube Trif., QPAR51

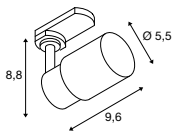

220-240V ~50/60Hz  
Material: alumínio



Casquilho: 1xGU10 Máx. Ø: 5,1 cm C: 5,5 cm

Versão	Art. n.º	EUR
● Preto	1008266	39,00
● Preto/dourado	1008267	39,00
○ Branco	1008268	39,00



LED GU10 51 mm | 6W | 38°  
3000K | 470lm | CEE=F  
6 kWh/1000h



Art. N.º: 1005079 | 7,50 EUR

PURI 2.0  
Cone Trif., QPAR51

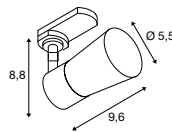

220-240V ~50/60Hz  
Material: alumínio



Casquilho: 1xGU10 Máx. Ø: 5,1 cm C: 5,5 cm

Versão	Art. n.º	EUR
● Preto	1008269	39,00
● Preto/dourado	1008270	39,00
○ Branco	1008271	39,00



LED GU10 51 mm | 6W | 36°  
2200-2700K | 360lm | CEE=G  
6 kWh/1000h



Art. N.º: 1005273 | 9,99 EUR

PURI 2.0  
Dome Trif., QPAR51

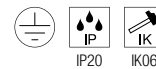
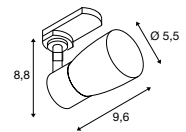

220-240V ~50/60Hz  
Material: alumínio



Casquilho: 1xGU10 Máx. Ø: 5,1 cm C: 5,5 cm

Versão	Art. n.º	EUR
● Preto	1008272	39,00
● Preto/dourado	1008273	39,00
○ Branco	1008274	39,00



LED GU10 51 mm | 6W | 38°  
2700K | 450lm | CEE=F  
6 kWh/1000h



Art. N.º: 1005077 | 7,50 EUR





PURI 2.0  
Tube PD, Trif., QPAR51

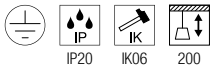
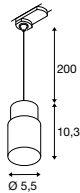

220-240V ~50/60Hz  
Material: alumínio



Casquilho: 1xGU10 Máx. Ø: 5,1 cm C: 5,5 cm

Versão	Art. n.º	EUR
● Preto	1008275	44,00
● Preto/dourado	1008276	44,00
○ Branco	1008277	44,00



LED GU10 51 mm | 6W | 36°  
2200-2700K | 360lm | CEE=G  
6 kWh/1000h



Art. N.º: 1005273 | 9,99 EUR

PURI 2.0  
Cone PD, Trif., QPAR51

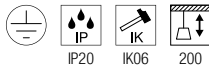
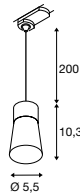

220-240V ~50/60Hz  
Material: alumínio



Casquilho: 1xGU10 Máx. Ø: 5,1 cm C: 5,5 cm

Versão	Art. n.º	EUR
● Preto	1008278	44,00
● Preto/dourado	1008279	44,00
○ Branco	1008280	44,00



LED GU10 51 mm | 6W | 38°  
2700K | 450lm | CEE=F  
6 kWh/1000h



Art. N.º: 1005077 | 7,50 EUR

PURI 2.0  
Dome PD, Trif., QPAR51

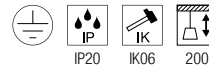
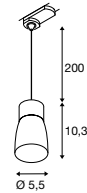

220-240V ~50/60Hz  
Material: alumínio



Casquilho: 1xGU10 Máx. Ø: 5,1 cm C: 5,5 cm

Versão	Art. n.º	EUR
● Preto	1008281	44,00
● Preto/dourado	1008282	44,00
○ Branco	1008283	44,00



LED GU10 51 mm | 6W | 38°  
3000K | 470lm | CEE=F  
6 kWh/1000h



Art. N.º: 1005079 | 7,50 EUR

1008360 + 1002819 622 + 623

## PURI 2.0 Basic Trif., QPAR51

MIX  
match

NEW

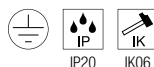
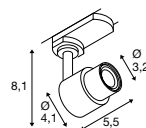

220-240V ~50/60Hz  
Material: alumínio

- Pode encontrar abajures a condizer na página 623

**SOCKET  
INSIDE** 6  
W

Casquilho: 1xGU10 Máx. Ø: 5,1 cm | C: 5,5 cm

Versão	Art. n.º	EUR
● Preto	1008359	35,00
○ Branco	1008360	35,00



LED GU10 51 mm | 6W | 38°  
3000K | 470lm | CEE=F  
6 kWh/1000h



Art. N.º: 1005080 | 7,50 EUR



### PURI 2.0 Basic PD, Trif., QPAR51

MIX  
match

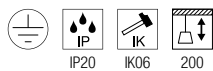
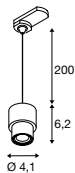

220-240V ~50/60Hz  
Material: alumínio

- Pode encontrar abajures a condizer na página 623



Casquilho: 1xGU10 Máx. Ø: 5,1 cm | C: 5,5 cm

Versão	Art. n.º	EUR
● Preto	1008210	35,00
○ Branco	1008211	35,00
● Cinzento	1008212	35,00



LED GU10 51 mm | 6W | 36°  
2200-2700K | 360lm | CEE=G



Art. N.º: 1005273 | 9,99 EUR

### PURI 2.0 Cone Abajur

MIX  
match



A: 6,5 cm  
Ø: 5,5 cm  
Material: alumínio

Versão	Art. n.º	EUR
● Preto	1008219	9,00
○ Branco	1008218	9,00
● Dourado	1008221	9,00
● Alumínio	1008377	9,00
● Cinzento	1008220	9,00
● Bronze	1008222	9,00

### PURI 2.0 Dome Abajur

MIX  
match



A: 6,5 cm  
Ø: 5,5 cm  
Material: alumínio

Versão	Art. n.º	EUR
● Preto	1008224	9,00
○ Branco	1008223	9,00
● Dourado	1008226	9,00
● Alumínio	1008378	9,00
● Cinzento	1008225	9,00
● Bronze	1008227	9,00

### PURI 2.0 Tube Abajur

MIX  
match



A: 6,5 cm  
Ø: 5,5 cm  
Material: alumínio

Versão	Art. n.º	EUR
● Preto	1008214	9,00
○ Branco	1008213	9,00
● Dourado	1008216	9,00
● Alumínio	1008376	9,00
● Cinzento	1008215	9,00
● Bronze	1008217	9,00

GRIP! M  
Trif., DALI, Ø 4,3 cm

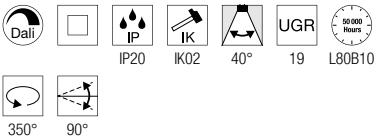
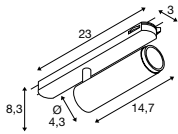

220-240V ~50/60Hz | 500mA  
Potência do sistema: 20W  
Material: alumínio



Down 1910lm | 2700K  
2040lm | 3000K

Versão	Art. n.º	EUR
● Preto/dourado 2700K	1008436	179,00
● Preto/dourado 3000K	1008438	179,00
○ Branco/Preto 2700K	1008435	179,00
○ Branco/Preto 3000K	1008437	179,00

GRIP! M  
Trif., DALI, Ø 4,3 cm

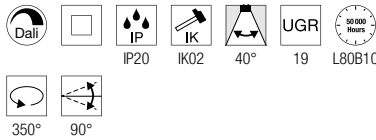
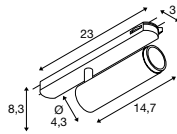

220-240V ~50/60Hz | 350mA  
Potência do sistema: 15W  
Material: alumínio



Down 780lm | 2000-3000K

Versão	Art. n.º	EUR
● Preto/dourado	1008440	179,00
○ Branco/Preto	1008439	179,00

1008437 624







**GRIP! M**  
Trif., PHASE, Ø 4,3 cm

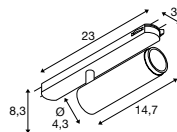

220-240V ~50/60Hz | 500mA  
Potência do sistema: 20W  
Material: alumínio



Down 1910lm | 2700K  
2040lm | 3000K

Versão	Art. n.º	EUR
● Preto/dourado 2700K	1008442	179,00
● Preto/dourado 3000K	1008444	179,00
○ Branco/Preto 2700K	1008441	179,00
○ Branco/Preto 3000K	1008443	179,00

**GRIP! M**  
Trif., PHASE, Ø 4,3 cm

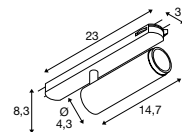

220-240V ~50/60Hz | 350mA  
Potência do sistema: 15W  
Material: alumínio



Down 780lm | 2000-3000K

Versão	Art. n.º	EUR
● Preto/dourado	1008446	179,00
○ Branco/Preto	1008445	179,00

1008438 + 1008493 624 + 627





**GRIP! L**  
Trif., QPAR51, Ø 5,7cm

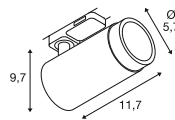

220-240V ~50/60Hz  
Material: alumínio



Casquilho: 1xGU10 Máx. Ø: 5,1 cm | C: 5,4 cm

Versão	Art. n.º	EUR
● Preto/dourado	<b>1008453</b>	<b>89,00</b>
● Branco/Preto	<b>1008452</b>	<b>89,00</b>



LED GU10 51 mm | 6W | 38°  
2700K | 450lm | CEE=F  
6 kWh/1000h



Art. N.º: **1005077** | **7,50 EUR**

**GRIP! M**  
Anel decorativo Ø 4,0 cm



A: 1,4 cm  
Ø: 4 cm  
Material: alumínio

Versão	Art. n.º	EUR
● Preto	<b>1008493</b>	<b>20,00</b>
○ Branco	<b>1008492</b>	<b>20,00</b>
● Dourado	<b>1008495</b>	<b>20,00</b>
● Níquel	<b>1008494</b>	<b>20,00</b>

**GRIP! L**  
Deco Ring Ø 5,4 cm



A: 3,4 cm  
Ø: 5,4 cm  
Material: alumínio

Versão	Art. n.º	EUR
● Preto	<b>1008497</b>	<b>22,00</b>
○ Branco	<b>1008496</b>	<b>22,00</b>
● Dourado	<b>1008499</b>	<b>22,00</b>
● Níquel	<b>1008498</b>	<b>22,00</b>

NUMINOS® S  
Trif.

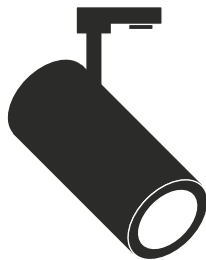

● Preto

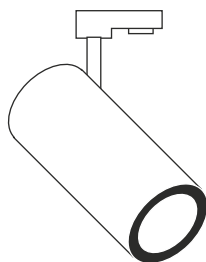
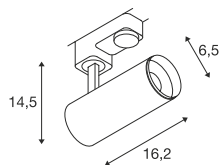

○ Branco



200mA  
220-240V ~50/60Hz  
Potência do sistema: 8,6W  
Material: alumínio/plástico











Versão	EUR
Versões S	115,00
Versões S DALI	165,00

Nota:  
Anel decorativo também  
disponível em branco,  
dourado e cobre



Versão	Art. n.º	EUR
Anel frontal S		
○ Branco	1006167	1,30
Anel frontal S		
● Dourado	1008144	8,00
Anel frontal S		
● Cobre	1008140	8,00



				UGR	Art. N.º	
	2700K	930lm	24°	16	<b>1004074</b>	
		944lm	36°	16	<b>1004075</b>	
		960lm	60°	19	<b>1004076</b>	
	3000K	1016lm	24°	13	<b>1004082</b>	
		1037lm	36°	13	<b>1004083</b>	
		1042lm	60°	19	<b>1004084</b>	
	4000K	1074lm	24°	16	<b>1004090</b>	
		1092lm	36°	16	<b>1004091</b>	
		1098lm	60°	19	<b>1004092</b>	
	2700K	930lm	24°	16	<b>1004362</b>	
		944lm	36°	16	<b>1004363</b>	
		960lm	60°	19	<b>1004364</b>	
	3000K	1016lm	24°	13	<b>1004370</b>	
		1037lm	36°	13	<b>1004371</b>	
		1042lm	60°	19	<b>1004372</b>	
	4000K	1074lm	24°	16	<b>1004378</b>	
		1092lm	36°	16	<b>1004379</b>	
		1098lm	60°	19	<b>1004380</b>	
	2700K	930lm	24°	16	<b>1004078</b>	
		944lm	36°	16	<b>1004079</b>	
		960lm	60°	19	<b>1004080</b>	
	3000K	1016lm	24°	13	<b>1004086</b>	
		1037lm	36°	13	<b>1004087</b>	
		1042lm	60°	19	<b>1004088</b>	
	4000K	1074lm	24°	16	<b>1004094</b>	
		1092lm	36°	16	<b>1004095</b>	
		1098lm	60°	19	<b>1004096</b>	
	2700K	930lm	24°	16	<b>1004366</b>	
		944lm	36°	16	<b>1004367</b>	
		960lm	60°	19	<b>1004368</b>	
	3000K	1016lm	24°	13	<b>1004374</b>	
		1037lm	36°	13	<b>1004375</b>	
		1042lm	60°	19	<b>1004376</b>	
	4000K	1074lm	24°	16	<b>1004382</b>	
		1092lm	36°	16	<b>1004383</b>	
		1098lm	60°	19	<b>1004384</b>	

NUMINOS® M  
Trif.

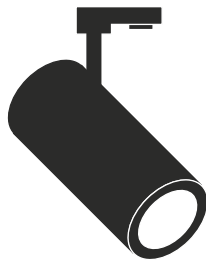

● Preto

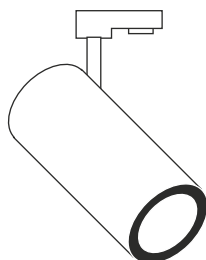
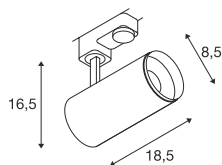

○ Branco



350mA  
220-240V ~50/60Hz  
Potência do sistema: 14W  
Material: alumínio/plástico











Versão	EUR
Versões M	145,00
Versões M DALI	197,00

Nota:  
Anel decorativo também  
disponível em branco,  
dourado e cobre



Versão	Art. n.º	EUR
Anel frontal M		
○ Branco	1006168	2,40
Anel frontal M		
● Dourado	1008145	9,00
Anel frontal M		
● Cobre	1008141	9,00



				UGR	Art. N.º	
	2700K	1750lm	24°	16	<b>1004170</b>	
		1744lm	36°	16	<b>1004171</b>	
		1697lm	60°	22	<b>1004172</b>	
	3000K	1804lm	24°	16	<b>1004178</b>	
		1790lm	36°	13	<b>1004179</b>	
		1749lm	60°	22	<b>1004180</b>	
	4000K	1931lm	24°	19	<b>1004186</b>	
		1927lm	36°	16	<b>1004187</b>	
		1872lm	60°	25	<b>1004188</b>	
	2700K	1750lm	24°	16	<b>1004458</b>	
		1744lm	36°	16	<b>1004459</b>	
		1697lm	60°	22	<b>1004460</b>	
	3000K	1804lm	24°	16	<b>1004466</b>	
		1790lm	36°	13	<b>1004467</b>	
		1749lm	60°	22	<b>1004468</b>	
	4000K	1931lm	24°	19	<b>1004474</b>	
		1927lm	36°	16	<b>1004475</b>	
		1872lm	60°	25	<b>1004476</b>	
	2700K	1750lm	24°	16	<b>1004174</b>	
		1744lm	36°	16	<b>1004175</b>	
		1697lm	60°	22	<b>1004176</b>	
	3000K	1804lm	24°	16	<b>1004182</b>	
		1790lm	36°	13	<b>1004183</b>	
		1749lm	60°	22	<b>1004184</b>	
	4000K	1931lm	24°	19	<b>1004190</b>	
		1927lm	36°	16	<b>1004191</b>	
		1872lm	60°	25	<b>1004192</b>	
	2700K	1750lm	24°	16	<b>1004462</b>	
		1744lm	36°	16	<b>1004463</b>	
		1697lm	60°	22	<b>1004464</b>	
	3000K	1804lm	24°	16	<b>1004470</b>	
		1790lm	36°	13	<b>1004471</b>	
		1749lm	60°	22	<b>1004472</b>	
	4000K	1931lm	24°	19	<b>1004478</b>	
		1927lm	36°	16	<b>1004479</b>	
		1872lm	60°	25	<b>1004480</b>	

NUMINOS® L  
Trif.

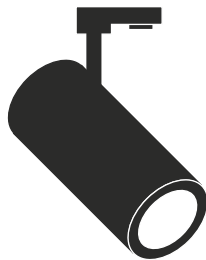

● Preto

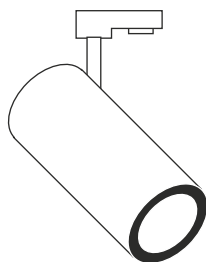
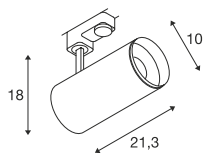

○ Branco



500mA  
220-240V ~50/60Hz  
Potência do sistema: 19W  
Material: alumínio/plástico

Versão	EUR
Versões L	155,00
Versões L DALI	215,00











**Nota:**  
Anel decorativo também disponível em branco, dourado e cobre



Versão	Art. n.º	EUR
Anel frontal L		
○ Branco	1006169	2,40
Anel frontal L		
● Dourado	1008146	10,00
Anel frontal L		
● Cobre	1008142	10,00





				UGR	Art. N.º	
	2700K	2370lm	24°	19	<b>1004266</b>	
		2245lm	36°	19	<b>1004267</b>	
		2304lm	60°	22	<b>1004268</b>	
	3000K	2432lm	24°	13	<b>1004274</b>	
		2320lm	36°	13	<b>1004275</b>	
		2373lm	60°	22	<b>1004276</b>	
	4000K	2694lm	24°	19	<b>1004282</b>	
		2557lm	36°	19	<b>1004283</b>	
		2601lm	60°	22	<b>1004284</b>	
	2700K	2370lm	24°	19	<b>1004554</b>	
		2245lm	36°	19	<b>1004555</b>	
		2304lm	60°	22	<b>1004556</b>	
	3000K	2432lm	24°	13	<b>1004562</b>	
		2320lm	36°	13	<b>1004563</b>	
		2373lm	60°	22	<b>1004564</b>	
	4000K	2694lm	24°	19	<b>1004570</b>	
		2557lm	36°	19	<b>1004571</b>	
		2601lm	60°	22	<b>1004572</b>	
	2700K	2370lm	24°	19	<b>1004270</b>	
		2245lm	36°	19	<b>1004271</b>	
		2304lm	60°	22	<b>1004272</b>	
	3000K	2432lm	24°	13	<b>1004278</b>	
		2320lm	36°	13	<b>1004279</b>	
		2373lm	60°	22	<b>1004280</b>	
	4000K	2694lm	24°	19	<b>1004286</b>	
		2557lm	36°	19	<b>1004287</b>	
		2601lm	60°	22	<b>1004288</b>	
	2700K	2370lm	24°	19	<b>1004558</b>	
		2245lm	36°	19	<b>1004559</b>	
		2304lm	60°	22	<b>1004560</b>	
	3000K	2432lm	24°	13	<b>1004566</b>	
		2320lm	36°	13	<b>1004567</b>	
		2373lm	60°	22	<b>1004568</b>	
	4000K	2694lm	24°	19	<b>1004574</b>	
		2557lm	36°	19	<b>1004575</b>	
		2601lm	60°	22	<b>1004576</b>	

# NUMINOS® XL

Trif.

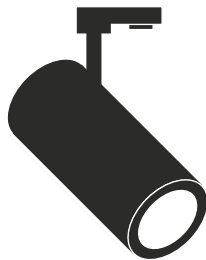

● Preto

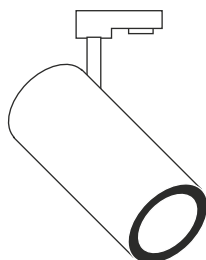
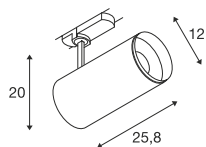

○ Branco



700mA  
220-240V ~50/60Hz  
Potência do sistema: 26W  
Material: alumínio/policarbonato (PC)











Versão	EUR
Versões XL	165,00
Versões XL DALI	235,00

**Nota:**  
Anel decorativo também disponível em branco, dourado e cobre



Versão	Art. n.º	EUR
Anel frontal XL		
○ Branco	1006170	3,55
Anel frontal XL		
● Dourado	1008147	11,00
Anel frontal XL		
● Cobre	1008143	11,00



				UGR	Art. N.º	
	2700K	3566lm	24°	19	<b>1005723</b>	
		3542lm	36°	19	<b>1005724</b>	
		3152lm	60°	25	<b>1005725</b>	
	3000K	3586lm	24°	19	<b>1005729</b>	
		3536lm	36°	19	<b>1005730</b>	
		3135lm	60°	25	<b>1005731</b>	
	4000K	3891lm	24°	19	<b>1005735</b>	
		3840lm	36°	19	<b>1005736</b>	
		3438lm	60°	25	<b>1005737</b>	
	2700K	3566lm	24°	19	<b>1005795</b>	
		3542lm	36°	19	<b>1005796</b>	
		3152lm	60°	25	<b>1005797</b>	
	3000K	3586lm	24°	19	<b>1005801</b>	
		3536lm	36°	19	<b>1005802</b>	
		3135lm	60°	25	<b>1005803</b>	
	4000K	3891lm	24°	19	<b>1005807</b>	
		3840lm	36°	19	<b>1005808</b>	
		3438lm	60°	25	<b>1005809</b>	
	2700K	3566lm	24°	19	<b>1005726</b>	
		3542lm	36°	19	<b>1005727</b>	
		3152lm	60°	25	<b>1005728</b>	
	3000K	3586lm	24°	19	<b>1005732</b>	
		3536lm	36°	19	<b>1005733</b>	
		3135lm	60°	25	<b>1005734</b>	
	4000K	3891lm	24°	19	<b>1005738</b>	
		3840lm	36°	19	<b>1005739</b>	
		3438lm	60°	25	<b>1005740</b>	
	2700K	3566lm	24°	19	<b>1005798</b>	
		3542lm	36°	19	<b>1005799</b>	
		3152lm	60°	25	<b>1005800</b>	
	3000K	3586lm	24°	19	<b>1005804</b>	
		3536lm	36°	19	<b>1005805</b>	
		3135lm	60°	25	<b>1005806</b>	
	4000K	3891lm	24°	19	<b>1005810</b>	
		3840lm	36°	19	<b>1005811</b>	
		3438lm	60°	25	<b>1005812</b>	

# NUMINOS® ZOOM M

Trif.

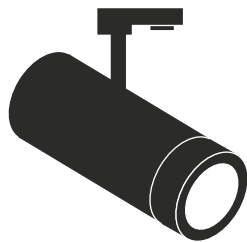

● Preto

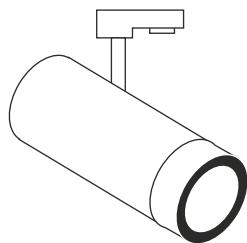



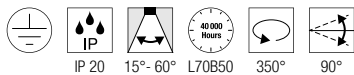
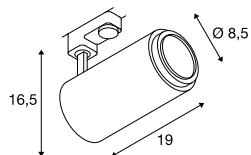







○ Branco



350mA  
220-240V ~50/60Hz  
Potência do sistema: 14W  
Material: alumínio/policarbonato (PC)

Versão	EUR
Versões M	183,00
Versões M DALI	232,00



				UGR	Art. N.º	
	2700K	617-1587lm		25	<b>1006108</b>	
	3000K	630 - 1625lm	15° - 60°	25	<b>1006110</b>	
	4000K	672 - 1743lm		25	<b>1006112</b>	
	2700K	617-1587lm		25	<b>1006114</b>	
	3000K	630 - 1625lm	15° - 60°	25	<b>1006116</b>	
	4000K	672 - 1743lm		25	<b>1006118</b>	
	2700K	617-1587lm		25	<b>1006109</b>	
	3000K	630 - 1625lm	15° - 60°	25	<b>1006111</b>	
	4000K	672 - 1743lm		25	<b>1006113</b>	
	2700K	617-1587lm		25	<b>1006115</b>	
	3000K	630 - 1625lm	15° - 60°	25	<b>1006117</b>	
	4000K	672 - 1743lm		25	<b>1006119</b>	

# CONFIGURE O SEU NUMINOS®

---

SELECIONE O SEU

SISTEMA

COR

---

NUMINOS® DL

NUMINOS® MOVE

NUMINOS® GIMBLE

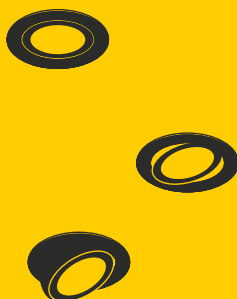

NUMINOS® PD

NUMINOS® CL

NUMINOS® SPOT



Preto

Branco

NUMINOS® TRACK

NUMINOS® ZOOM



Preto

Branco

O sistema de iluminação NUMINOS® oferece propriedades de iluminação constantes e design moderno em todas as aplicações: desde hotéis a escritórios, passando por espaços comerciais ou privados. Da aplicação à tecnologia e ao design em detalhes: é bom que as luminárias modulares Downlight e Spotlight possam ser configuradas exatamente conforme o planejamento ou as condições do espaço a iluminar. Graças à qualidade da luz normalizada para toda a família, as versões Numinos podem ser perfeitamente combinadas entre si, independentemente do tipo de instalação no projeto. Quanto mais multifacetado for o seu projeto, mais beneficia da família NUMINOS®.

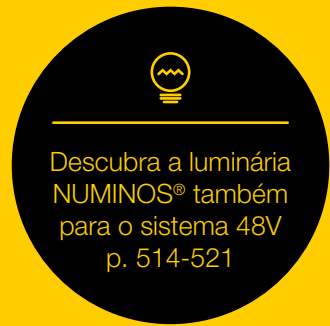

## TAMANHO

## DESEMPENHO

## DIFUSORES

TAMANHO	DESEMPENHO
<b>XS</b>	<b>XS</b> 200mA Consumo de energia: 7W
<b>S</b>	<b>S</b> 250mA Consumo de energia: 8,6W
<b>M</b>	<b>M</b> 500mA Consumo de energia: 17,5W
<b>L</b>	<b>L</b> 700mA Consumo de energia: 25,4W
<b>XL</b>	<b>XL</b> 1050mA Consumo de energia: 37,4W

<b>ELÍPTICO</b> Luz distribuída longitudinalmente, brilho ligeiramente reduzido, ideal para utilização em corredores
<b>PRISMÁTICO</b> Feixe de luz mais largo, menos brilho, perfeito para colocar as luminárias a distâncias específicas
<b>FOSCO</b> Feixe de luz mais largo, maior iluminação, ideal para tetos baixos
<b>ALVEOLAR</b> Feixe de luz estreito, brilho reduzido, ideal para trabalhar no computador

TAMANHO	DESEMPENHO
<b>S</b>	<b>S</b> 200mA Consumo de energia: 11W
<b>M</b>	<b>M</b> 350mA Consumo de energia: 20W
<b>L</b>	<b>L</b> 500mA Consumo de energia: 28W
<b>XL</b>	<b>XL</b> 700mA Consumo de energia: 36W

<b>S</b>	<b>M</b>	<b>L</b>	<b>XL</b>
----------	----------	----------	-----------

NUMINOS® Zoom só disponível no tamanho M

# NUMINOS®

# DOWN-/SPOTLIGHTS

---



Descubra  
o configurador  
NUMINOS® em  
[slv.com](http://slv.com)

Disponível em três Versões de produto:  
DL, Move e Gimble. Todos disponíveis em  
três temperaturas de cor e nas dimensões  
XS, S, M, L e XL.

---

Refletores selecionáveis com  
ângulos de meia dispersão de  
20° a 55°.

---

Diferentes filtros de efeitos  
disponíveis como acessórios.

---

O anel decorativo pode ser selecionado  
como acabamento visível.

---

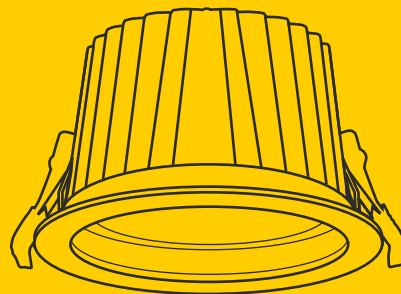

## DOWNLIGHTS

NUMINOS® Downlights disponíveis como Versões fixas ou orientáveis.



NUMINOS® UM SISTEMA DE ILUMINAÇÃO – MIL POSSIBILIDADES. O sistema de iluminação livremente configurável que dá a melhor iluminação a todos os ambientes. Nenhum projeto é igual a outro. No entanto, muitos projetos exigem um conceito uniforme de iluminação e design. NUMINOS® é um sistema de iluminação perfeitamente coordenado que combina função, design e tecnologia. Para projetistas e executantes. Para todos os requisitos. Para máxima diversidade com o mínimo de esforço.

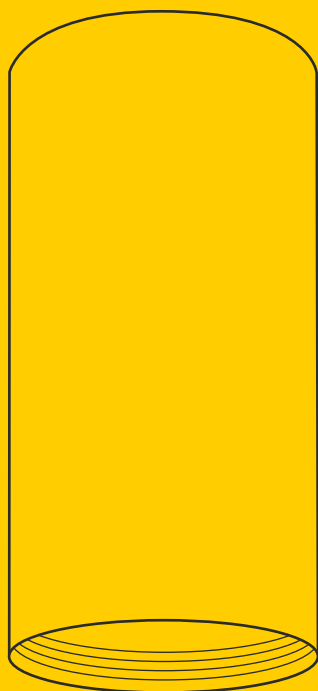

Disponível em quatro dimensões S, M, L, XL e em três temperaturas de cor.

Graças ao controlador LED integrado, todos os Spotlights são adequados para ligação direta à tensão de rede de 230 VAC.

---



Lentes seleccionáveis com ângulos de meia dispersão de 24° a 60°.

---



O anel decorativo pode ser seleccionado como acabamento visível.

---

## SPOTLIGHTS

NUMINOS® Os Spotlight estão disponíveis como projetores orientáveis ou fixos, luminária suspensa e como projetor para sistemas de calhas trifásicas.



1004771 643



## ONE 40 TRACK Trif., DALI

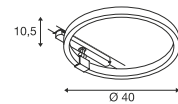

220-240V ~50/60Hz | 350mA  
Potência do sistema: 15,2W  
Material: alumínio



Down

670lm | 4000K

Versão	Art. n.º	EUR
● Preto	1004771	333,00
○ Branco	1004772	333,00

NOBLO SPOT  
Trif., PHASE

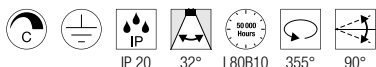
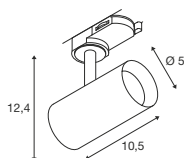

220-240V ~50/60Hz | 150mA  
Potência do sistema: 6W  
Material: alumínio/policarbonato (PC)



Down 740lm | 2700K

Versão	Art. n.º	EUR
● Preto	1007644	75,00
○ Branco	1007645	75,00



Artigo	Art. n.º	EUR
Anel decorativo		
● Preto	1008482	5,90
○ Branco	1008483	5,90
● Dourado	1008484	5,90
● Cinzento	1008485	5,90
● Cobre	1008486	5,90
● Bronze	1008487	5,90

NOBLO SPOT  
Trif., PHASE

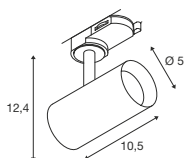

220-240V ~50/60Hz | 150mA  
Potência do sistema: 6W  
Material: alumínio/policarbonato (PC)



Down 750lm | 3000K

Versão	Art. n.º	EUR
● Preto	1007646	75,00
○ Branco	1007647	75,00



Artigo	Art. n.º	EUR
Anel decorativo		
● Preto	1008482	5,90
○ Branco	1008483	5,90
● Dourado	1008484	5,90
● Cinzento	1008485	5,90
● Cobre	1008486	5,90
● Bronze	1008487	5,90

1007646 644



1007469 645



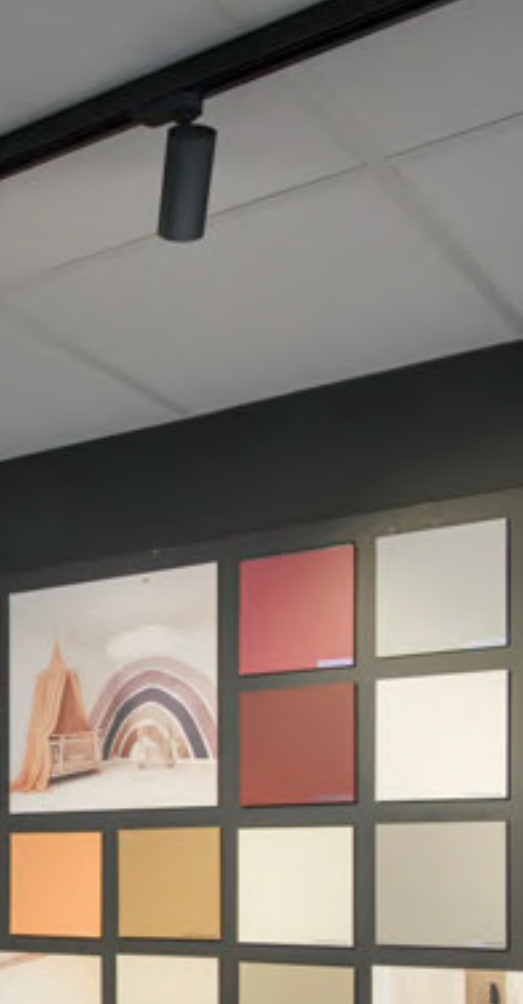

### NOBLO SPOT Trif., PHASE

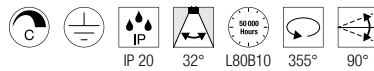
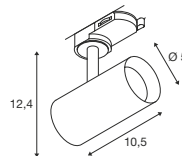

220-240V ~50/60Hz | 150mA  
Potência do sistema: 6W  
Material: alumínio/policarbonato (PC)



Down 760lm | 4000K

Versão	Art. n.º	EUR
● Preto	1007648	75,00
○ Branco	1007649	75,00



Artigo	Art. n.º	EUR
Anel decorativo		
● Preto	1008482	5,90
○ Branco	1008483	5,90
● Dourado	1008484	5,90
● Cinzento	1008485	5,90
● Cobre	1008486	5,90
● Bronze	1008487	5,90

### NOBLO SPOT Trif., PHASE

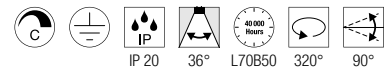
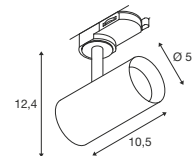

220-240V ~50/60Hz | 350mA  
Potência do sistema: 8,4W  
Material: alumínio/policarbonato (PC)



Down 30lm | 2000K - 450lm | 3000K

Versão	Art. n.º	EUR
● Preto	1007355	90,00
○ Branco	1007356	90,00



Artigo	Art. n.º	EUR
Anel decorativo		
● Preto	1008482	5,90
○ Branco	1008483	5,90
● Dourado	1008484	5,90
● Cinzento	1008485	5,90
● Cobre	1008486	5,90
● Bronze	1008487	5,90



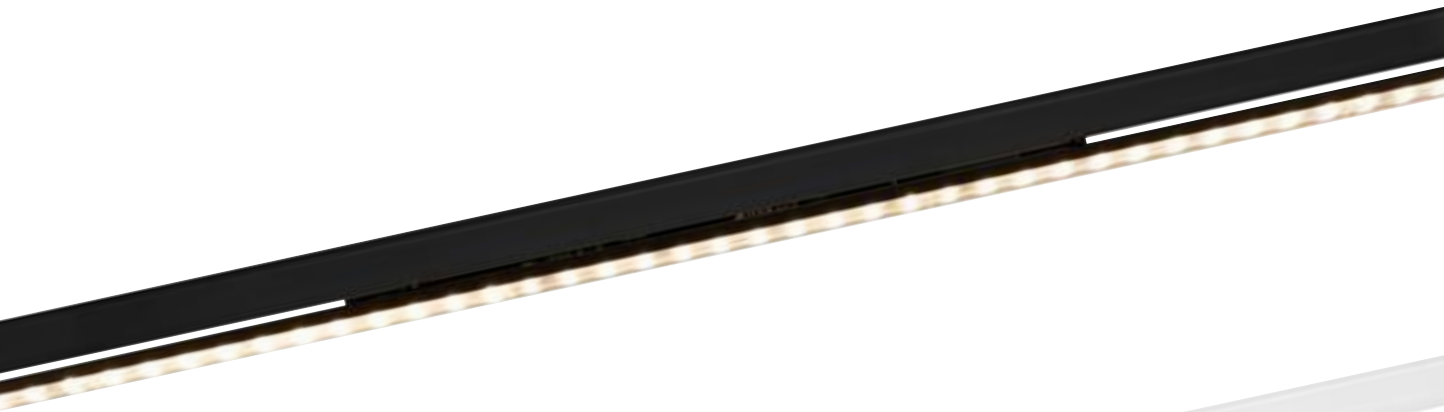



### SIGHT EASY Trif. DALI

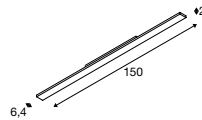
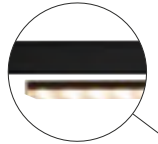

220-240V ~50/60Hz | 250/300/350/400mA  
Potência do sistema: 41|49|58|66W  
Material: alumínio



41W	6500lm	3000K
	7100lm	4000K
49W	7700lm	3000K
	8200lm	4000K
58W	9100lm	3000K
	9600lm	4000K
66W	10200lm	3000K
	10900lm	4000K

Versão	Art. n.º	EUR
● Preto 3000K	1008728	230,00
● Preto 4000K	1008730	230,00
○ Branco 3000K	1008729	230,00
○ Branco 4000K	1008731	230,00

### SIGHT EASY Trif.

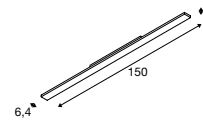
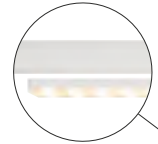

220-240V ~50/60Hz | 250/300/350/400mA  
Potência do sistema: 41|49|58|66W  
Material: alumínio



41W	6500lm	3000K
	7100lm	4000K
49W	7700lm	3000K
	8200lm	4000K
58W	9100lm	3000K
	9600lm	4000K
66W	10200lm	3000K
	10900lm	4000K

Versão	Art. n.º	EUR
● Preto 3000K	1008676	189,00
● Preto 4000K	1008678	189,00
○ Branco 3000K	1008677	189,00
○ Branco 4000K	1008679	189,00

## SIGHT TRACK

Trif., DALI

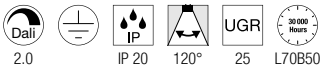
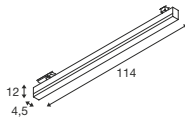

220-240V ~50/60Hz | 700mA  
 Potência do sistema: 39W  
 Material: alumínio/acrílico



Down 3000lm | 3000K | 3000lm | 4000K

Versão	Art. n.º	EUR
● Preto	1005397	375,00
○ Branco	1005399	375,00

## SIGHT TRACK

Trif.

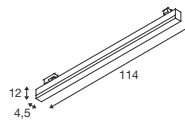

220-240V ~50/60Hz | 700mA  
 Potência do sistema: 37W  
 Material: alumínio/acrílico



Down 3000lm | 3000K | 3000lm | 4000K

Versão	Art. n.º	EUR
● Preto	1005400	309,00
○ Branco	1005401	309,00
● Cinzento	1005402	309,00

1005400 648







1005399 649

### SIGHT MOVE Trif., DALI

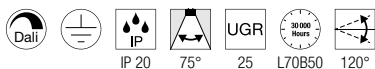
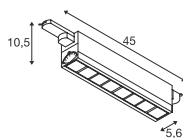

220-240V ~50/60Hz | 350mA  
Potência do sistema: 26W  
Material: alumínio/polimetilacrilato (PMMA)



Down 2700lm | 3000K  
3100lm | 4000K

Versão	Art. n.º	EUR
● Preto 2700lm   3000K	1004690	255,00
● Preto 3100lm   4000K	1004692	255,00
○ Branco 2700lm   3000K	1004691	255,00
○ Branco 3100lm   4000K	1004693	255,00

### SIGHT MOVE Trif.

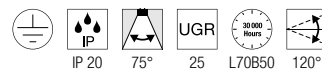
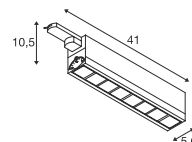

220-240V ~50/60Hz | 350mA  
Potência do sistema: 26W  
Material: alumínio/polimetilacrilato (PMMA)



Down 2700lm | 3000K  
3100lm | 4000K

Versão	Art. n.º	EUR
● Preto 2700lm   3000K	1004686	182,00
● Preto 3100lm   4000K	1004688	182,00
○ Branco 2700lm   3000K	1004687	182,00
○ Branco 3100lm   4000K	1004689	182,00



1008063 651



PARA CONE 14  
Trif., GU10

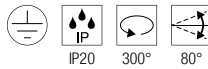
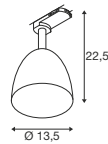

220-240V ~50/60Hz  
Material: aço



Casquilho: 1xGU10

Versão	Art. n.º	EUR
● Preto/dourado	1008055	86,00
○ Branco/dourado	1008056	86,00
○ Cobre/branco	1008057	89,00



LED GU10 | 6,5W | 330°  
2700K | 650lm | CEE=F  
7 kWh/1000h



Art. N.º: 1008375 | 44,00 EUR

PARA CONE 14  
Trif., PD, GU10

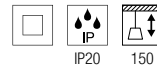
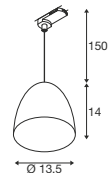

220-240V ~50/60Hz  
Material: aço



Casquilho: 1xGU10

Versão	Art. n.º	EUR
● Preto/dourado	1008061	117,00
○ Branco/dourado	1008062	117,00
○ Cobre/branco	1008063	124,00



LED GU10 | 3,2W  
2700K | 270lm | CEE=G



Art. N.º: 1006321 | 39,00 EUR

1006157 653

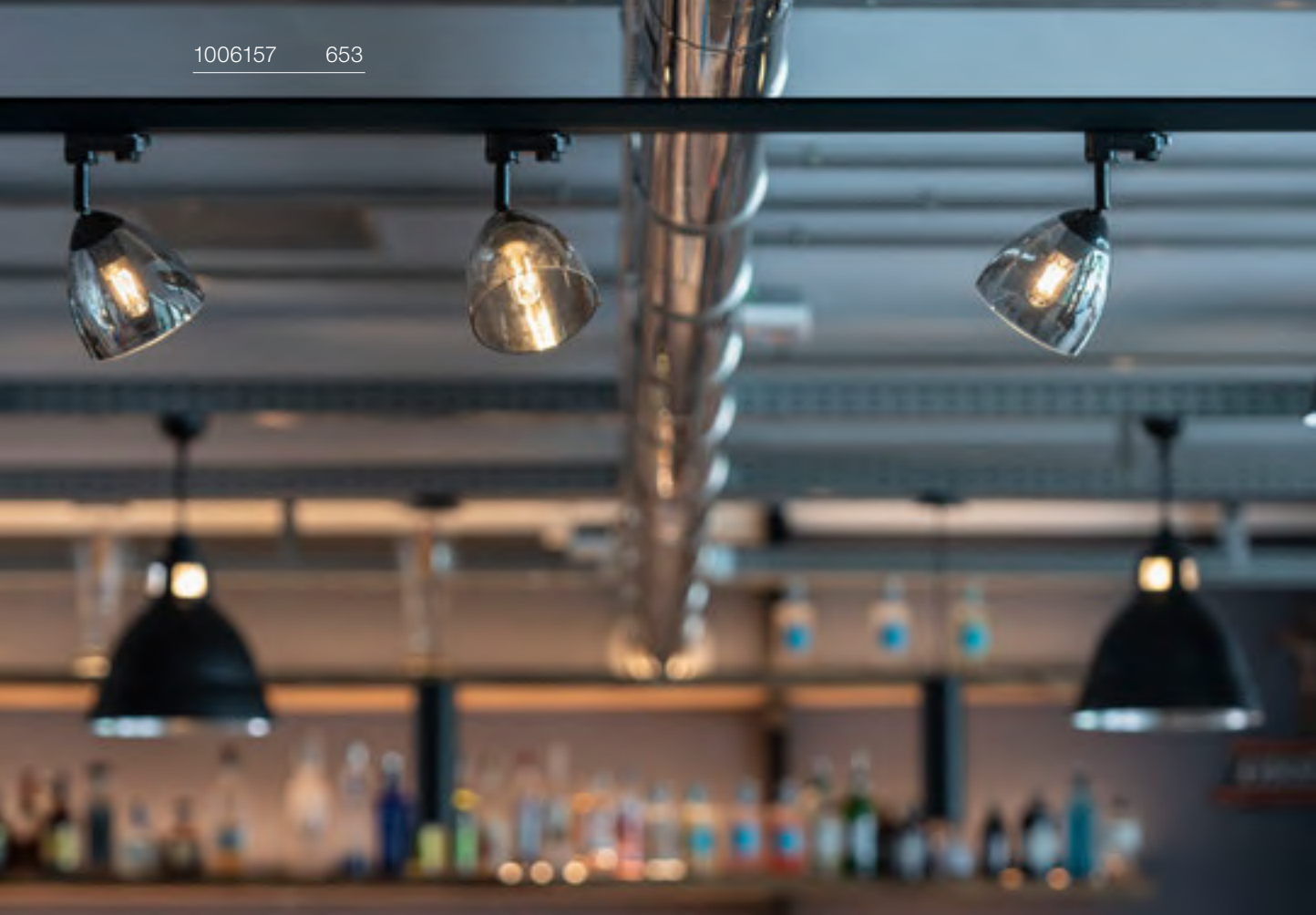

1006160 653





### PARA CONE GL Trif., GU10

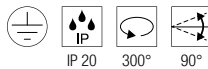
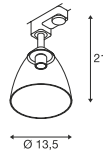

220-240V ~50/60Hz  
Material: alumínio/vidro



Casquilho: 1xGU10

Versão	Art. n.º	EUR
● Preto	1006157	102,00
○ Branco	1006158	102,00



LED GU10 | 3,2W  
2700K | 270lm | CEE=G



Art. N.º: 1006321 | 39,00 EUR

### PARA CONE GL PD, GU10

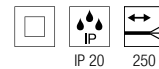
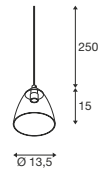

220-240V ~50/60Hz  
Material: alumínio/vidro

- Acessórios ver página 615
- Extremidade do cabo aberta



Casquilho: 1xGU10

Versão	Art. n.º	EUR
● Preto	1006159	84,00
○ Branco	1006160	84,00



LED GU10 | 3,2W  
2700K | 270lm | CEE=G



Art. N.º: 1006321 | 39,00 EUR



Artigo	Art. n.º	EUR
Adaptador da calha monofásica		
● Preto	143120	15,00
○ Branco	143121	15,00
● Cinzento	143124	15,00
Adaptador da calha trifásica		
● Preto	145990	19,70
● Cinzento	145994	19,70
○ Branco	1001542	19,70
Roseta saliente para teto		
● Preto	1004744	34,00
○ Branco	1004745	34,00
Roseta para encastrar no teto		
● Preto	1004674	22,50
○ Branco	1004675	22,50
FITU   Roseta para teto, 1 saída		
● Preto	132600	26,00
○ Branco	132601	26,00
● Cromado	132605	28,50

1008541 655





## FORCHINI M 40 TRACK

Trif., PD, E27

NEW

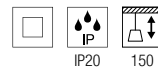
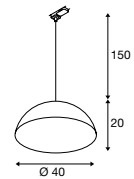

220-240V ~50/60Hz  
Material: aço/alumínio



Casquilho: 1xE27 máx. Ø: 6,8 cm | C: 15,2 cm

Versão	Art. n.º	EUR
● Preto/dourado	1008541	● 233,00



LED E27 | 7,5W | 320°  
2500K | 700lm | CEE=F  
8 kWh/1000h



Art. N.º: 1005265 | 26,50 EUR



1008171 657

## LIGHT EYE® 90

Trif., PD, QPAR51

NEW

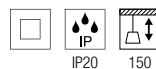
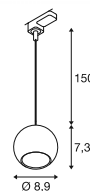

220-240V ~50/60Hz  
Material: aço



Casquilho: 1xGU10 máx. Ø: 5,1 cm | C: 5,35 cm

Versão	Art. n.º	EUR
● Preto	1008170	84,00
○ Branco	1008171	84,00



LED GU10 51 mm | 6W | 38°  
3000K | 470lm | CEE=F  
6 kWh/1000h



Art. N.º: 1005079 | 7,50 EUR





**LIGHT EYE® 150**  
Trif., PD, QPAR111

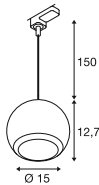

220-240V ~50/60Hz  
Material: aço



Casquilho: 1xGU10 máx. Ø: 11,1 cm | C: 7 cm

Versão	Art. n.º	EUR
● Preto	1008176	132,00
○ Branco	1008177	132,00



QPAR111 | 12,5W | 30°  
2700K | 950lm | CEE=F  
13 kWh/1000h



Art. N.º: 1005276 | 49,50 EUR

**LIGHT EYE® 150**  
Trif., QPAR111

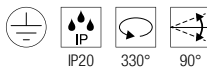
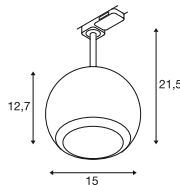

220-240V ~50/60Hz  
Material: aço



Casquilho: 1xGU10 máx. Ø: 11,1 cm | C: 7 cm

Versão	Art. n.º	EUR
● Preto	1008184	132,00
○ Branco	1008185	132,00



QPAR111 | 12W | 55°  
3000K | 680lm | CEE=G  
12 kWh/1000h



Art. N.º: 1005298 | 85,00 EUR

**LIGHT EYE® 90**  
Anel decorativo Ø 5,7 cm



Material: aço/aço  
A: 1,4 cm  
Ø: 5,9 cm

Versão	Art. n.º	EUR
● Preto	1008186	9,00
○ Branco	1008187	9,00
● Dourado	1008188	14,00

**LIGHT EYE® 150**  
Anel decorativo Ø 13,6 cm



Material: aço/aço  
A: 2,3 cm  
Ø: 13,6 cm

Versão	Art. n.º	EUR
● Preto	1008189	35,00
○ Branco	1008190	35,00
● Dourado	1008192	45,00
● Cromado	1008191	45,00

## ALTRA DICE TRACK

Trif., QPAR51

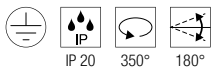
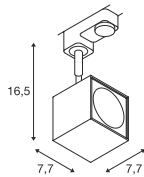

220-240V ~50/60Hz  
Material: alumínio



Casquilho: 1xGU10 máx. Ø: 5,1 cm | C: 5,7 cm

Versão	Art. n.º	EUR
● Preto	152320	96,00
○ Branco	152321	96,00



LED GU10 51 mm | 6W | 36°  
2200-2700K | 360lm | CEE=G  
6 kWh/1000h



Art. N.º: 1005075 | 7,50 EUR

## EURO CUBE

Trif.

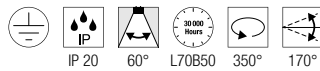
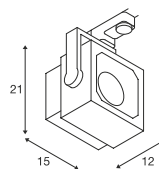

220-240V ~50/60Hz  
Potência total: 26W  
Material: alumínio



Down 2470lm | 3000K  
2740lm | 4000K

Versão	Art. n.º	EUR
● Preto		
2470lm   3000K	152750	260,00
○ Branco		
2470lm   3000K	152751	260,00
● Preto		
2740lm   4000K	152780	260,00
○ Branco		
2740lm   4000K	152781	260,00





### EURO SPOT TRACK

Trif., QPAR111

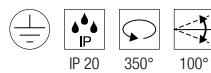
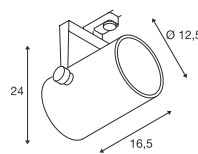

220-240V ~50/60Hz  
Material: alumínio



Casquilho: 1xGU10

Versão	Art. n.º	EUR
● Preto	153420	106,00
○ Branco	153421	106,00



QPAR111 | 12,5W | 30°  
2700K | 950lm | CEE=F  
13 kWh/1000h



Art. N.º: 1005276 | 49,50 EUR

### EURO SPOT TRACK

Trif., QPAR51

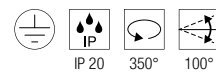
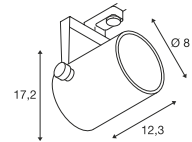

220-240V ~50/60Hz  
Material: alumínio



Casquilho: 1xGU10

Versão	Art. n.º	EUR
● Preto	153850	84,00
○ Branco	153851	84,00



LED GU10 51 mm | 6W | 36°  
2200-2700K | 360lm | CEE=G  
6 kWh/1000h



Art. N.º: 1005273 | 9,99 EUR

MENSEN DIE ZICH ELKE DAG KUNNEN GEVEN.  
ZIJ ZIJN DE MENSEN DIE IK BEWONDER.  
ZE ZIJN ECHTE MENSEN.

—Marcel Proust—

Succes is geboren uit arrogantie.  
Maar grootheid komt uit nederigheid.





PURI TRACK  
Trif., QPAR51

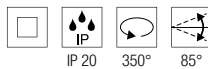
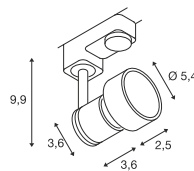

220-240V ~50/60Hz  
Material: alumínio/policarbonato (PC)

- Anel decorativo incl.



Casquilho: 1xGU10

Versão	Art. n.º	EUR
● Preto	153560	35,75
○ Branco	153561	35,75
● Cinzento	153564	35,75



LED GU10 51 mm | 6W | 36°  
2200-2700K | 360lm | CEE=G  
6 kWh/1000h



Art. N.º: 1005273 | 9,99 EUR

PURI TRACK  
Trif., QPAR51

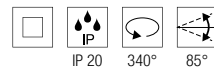
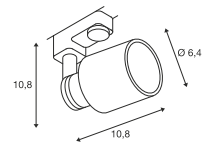

220-240V ~50/60Hz  
Material: alumínio/plástico



Casquilho: 1xGU10

Versão	Art. n.º	EUR
● Preto	1001871	45,00
○ Branco	1001872	45,00



LED GU10 51 mm | 6W | 38°  
2700K | 450lm | CEE=F  
6 kWh/1000h



Art. N.º: 1005077 | 7,50 EUR

**KALU TRACK**  
Trif., PHASE

**KALU TRACK**  
Trif., QPAR111

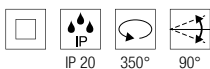
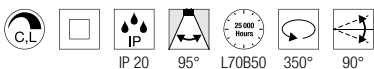
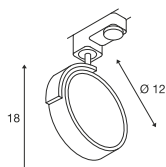
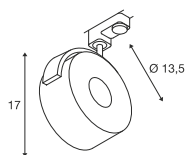

220-240V ~50/60Hz  
Potência do sistema: 13W  
Material: alumínio

220-240V ~50/60Hz  
Material: alumínio/plástico



Down 970lm | 3000K

Casquilho: 1xGU10

Versão	Art. n.º	EUR
● Preto		
IRC80	<b>152600</b>	<b>219,00</b>
○ Branco		
IRC90	<b>152601</b>	<b>219,00</b>

Versão	Art. n.º	EUR
● Preto	<b>152610</b>	<b>89,00</b>
○ Branco	<b>152611</b>	<b>89,00</b>



QPAR111 | 12,5W | 10°  
3000K | 950lm | CEE=F  
13 kWh/1000h



Art. N.º: **1005278** | **55,00 EUR**



152611 662



152601 662

**BIMA**  
Trif., single, QPAR51

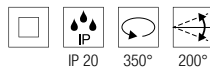
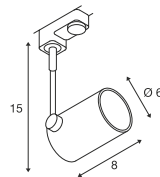

220-240V ~50/60Hz  
Material: alumínio



Casquilho: 1xGU10 máx. Ø: 5,1 cm | C: 5,7 cm

Versão	Art. n.º	EUR
● Preto	152240	45,00
○ Branco	152241	45,00
● Cinzento	152242	45,00



LED GU10 51 mm | 6W | 36°  
2200-2700K | 360lm | CEE=G



Art. N.º: 1005273 | 9,99 EUR

**BIMA**  
Trif., double, QPAR51

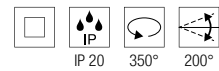
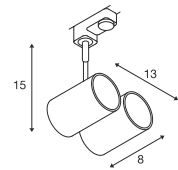

220-240V ~50/60Hz  
Material: alumínio



Casquilho: 2xGU10 máx. Ø: 5,1 cm | C: 5,7 cm

Versão	Art. n.º	EUR
● Preto	152230	70,00
○ Branco	152231	70,00
● Cinzento	152232	70,00



LED GU10 51 mm | 6W | 36°  
2200-2700K | 360lm | CEE=G



Art. N.º: 1005075 | 7,50 EUR



152240 663







### HELIA 50 TRACK Trif.

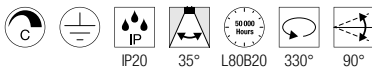
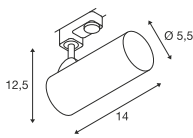

220-240V ~50/60Hz | 500  
Potência do sistema: 11W  
Material: alumínio



Down 810lm | 3000K  
880lm

Versão	Art. n.º	EUR
● Preto		
810lm	<b>152960</b>	<b>90,00</b>
○ Branco		
880lm	<b>152961</b>	<b>90,00</b>

### ENOLA C TRACK Trif.

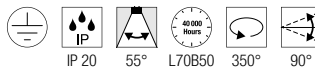
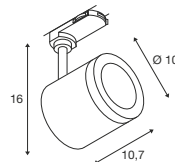

220-240V ~50/60Hz | 500mA  
Potência do sistema: 11W  
Material: alumínio



Down 1040lm | 3000K

Versão	Art. n.º	EUR
● Preto	<b>152430</b>	<b>177,00</b>
○ Branco	<b>152431</b>	<b>177,00</b>

### AVO TRACK Trif., QPAR51

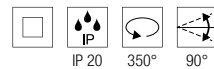
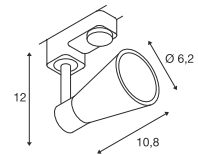

220-240V ~50/60Hz  
Material: aço



Casquilho: 1xGU10 máx. Ø: 5,1 cm

Versão	Art. n.º	EUR
● Preto	<b>152640</b>	<b>44,50</b>
○ Branco	<b>152641</b>	<b>44,50</b>



LED GU10 51 mm | 6W | 38°  
2700K | 450lm | CEE=F  
6 kWh/1000h



Art. N.º: **1005076** | **7,50 EUR**

# SISTEMAS DE CALHAS TRIFÁSICAS

Construção profissional: uma iluminação bem pensada é essencial, especialmente onde há muito para ver. Por serem luminárias que podem ser utilizadas de forma flexível na calha eletrificada, permitem iluminar perfeitamente os objetos desejados. O conceito de iluminação pode ser alterado em qualquer momento. As calhas eletrificadas de 3 circuitos (trifásicas) são ideais para utilização em lojas, stands de exposição e na gastronomia. Em conjunto com as luminárias SLV adequadas, permitem criar o ambiente perfeito e realçam materiais e peças de exposição à luz certa.

ONDE PRETENDE  
INSTALAR O SEU  
SISTEMA?



CONFIGURAÇÃO  
DAS CALHAS

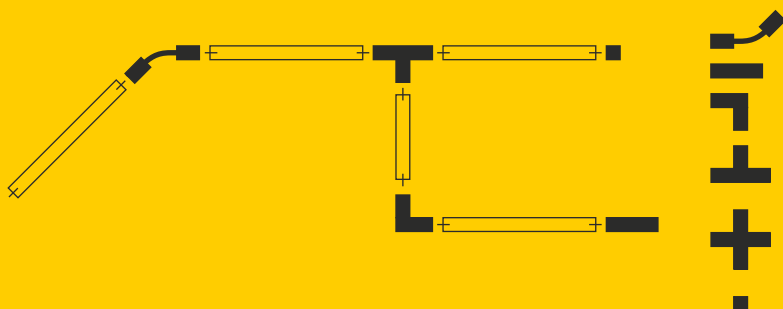

Utilize também o nosso configurador Track:

[www.slv.com/pt\\_pt/servico/configurador-de-sistema-de-calha-slv](http://www.slv.com/pt_pt/servico/configurador-de-sistema-de-calha-slv)

# ESCOLHA E SEU SISTEMA DE CALHAS



## S-TRACK

Sistema trifásico com opção DALI



Encastrar



Saliente



## EUTRAC

Sistema trifásico

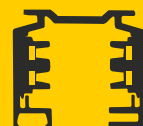

Encastrar



Saliente



Seleção da cor

Preto/ branco



1m - 2m - 3m - 4m



Branco



1m - 2m - 3m



Preto/ cinzento/ branco



1m - 2m - 3m



Escolha a sua luminária!



## JÁ ESTÁ!

Diferentes opções de configuração, individualmente adaptadas ao seu espaço



PERFIS

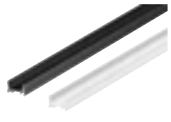

GRAZIA 10 PERFIL SALIENTE | 669



GRAZIA 10 PERFIL DE ENCASTRAR | 669

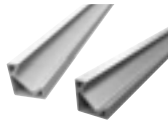

GRAZIA 10 EDGE | 672

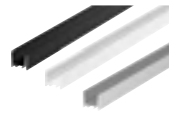

GRAZIA 20 PERFIL SALIENTE | 675



GRAZIA 20 PERFIL DE ENCASTRAR | 675



GRAZIA 60 PERFIL SALIENTE | 679

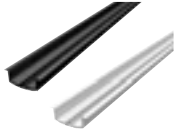

GRAZIA 60 PERFIL DE ENCASTRAR | 679

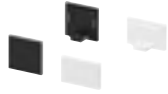

GRAZIA 10 ACESSÓRIOS | 671



GRAZIA 10 EDGE ACESSÓRIOS | 673



GRAZIA 20 ACESSÓRIOS | 676-677



GRAZIA 60 ACESSÓRIOS | 680-681

LED-STRIPS



GRAZIA LED STRIP VALUE ADDITIONAL LIGHTING E ACESSÓRIOS | 684



GRAZIA LED STRIP VALUE MAIN LIGHTING E ACESSÓRIOS | 685



GRAZIA LED STRIP VALUE MAIN LIGHTING + E ACESSÓRIOS | 686



GRAZIA LED STRIP CORE MAIN LIGHTING E ACESSÓRIOS | 687



GRAZIA PRO MAX FLEXSTRIP E ACESSÓRIOS | 688

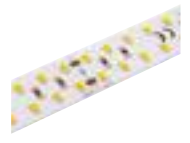

GRAZIA PRO MAX FLEXSTRIP E ACESSÓRIOS | 689



GRAZIA PRO FLEX-STRIP TUNABLE WHITE E ACESSÓRIOS | 690



GRAZIA PRO FLEXSTRIP RGBW E ACESSÓRIOS | 691



GRAZIA IP FLEXSTRIP | 692



GRAZIA IP FLEXSTRIP TUNABLE WHITE E ACESSÓRIOS | 693



GRAZIA IP FLEXSTRIP RGBW E ACESSÓRIOS | 693



## GRAZIA 10

### Perfil saliente, rebaixado, 2 m

Material: alumínio  
Largura: 1,75 cm, altura: 1,1 cm  
Largura máx. Led-strip em mm: 10  
Não inclui cobertura

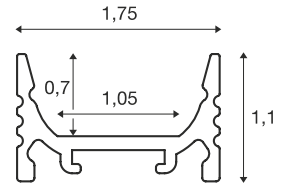

IP 20

Comprimento (cm)	Cor	Material	Art. n.º	EUR
200	● Preto	Alumínio	1000462	29,00
	○ Branco		1000461	29,00

## GRAZIA 10

### Perfil saliente, elevado, 2m

Material: alumínio  
Largura: 1,75 cm, altura: 1,62 cm  
Largura máx. Led-strip em mm: 10  
Não inclui cobertura

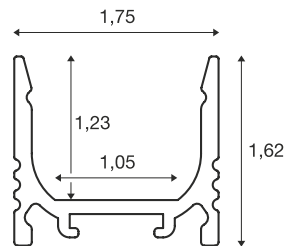

IP 20

Comprimento (cm)	Cor	Material	Art. n.º	EUR
200	● Preto	Alumínio	1000465	29,00
	○ Branco		1000464	29,00

## GRAZIA 10

### Perfil de encastrar

Material: alumínio  
Largura: 3 cm, altura: 1,62 cm  
Largura máx. Led-strip em mm: 10  
Não inclui cobertura

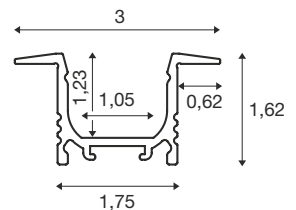

IP 20

Comprimento (cm)	Cor	Material	Art. n.º	EUR
200	● Preto	Alumínio	1000459	34,00
	○ Branco		1000458	34,00





# ACESSÓRIOS

## GRAZIA 10 Difusores



Descrição	Acabamento	Comprimento (cm)	Largura (cm)	Altura (cm)	Material	Art. n.º	EUR
Difusor	<input type="radio"/> Leitoso	200	1,58	0,4	Policarbonato (PC)	1000466	18,00
	<input type="radio"/> Fosco				Polimetilacrilato (PMMA)	1000468	24,00
	<input type="radio"/> Acetinado					1000469	24,00

## GRAZIA 10 Acessórios de montagem



Descrição	Cor	Largura (cm)	Altura (cm)	Profundidade (cm)	Material	Art. n.º	EUR
Acessórios de montagem	<input type="radio"/> Prateado, 45°		0,001		Aço	1000489	5,40
	<input checked="" type="radio"/> Aço inoxidável, não visível	1,53	0,3		Aço inoxidável	1000487	4,30

Unidade embalada: 2 artigos

## GRAZIA 10 Tampas para perfil saliente



Descrição	Cor	Comprimento (cm)	Largura (cm)	Altura (cm)	Material	Art. n.º	EUR
Tampas	<input checked="" type="radio"/> Preto, liso		1,75	1,1	Alumínio	1000477	6,85
	<input type="radio"/> Branco, liso			1,1		1000476	6,85
Tampas	<input checked="" type="radio"/> Preto, padrão		1,75	1,62	Alumínio	1000480	6,85
	<input type="radio"/> Branco, padrão			1,62		1000479	6,85

Unidade embalada: 2 artigos

## GRAZIA 10 Tampas para perfil de encastrar



Descrição	Cor	Comprimento (cm)	Largura (cm)	Altura (cm)	Material	Art. n.º	EUR
Tampas	<input checked="" type="radio"/> Preto		3	1,62	Alumínio	1000474	6,85
	<input type="radio"/> Branco					1000473	6,85

Unidade embalada: 2 artigos



## GRAZIA 10 EDGE

2 m

Material: alumínio  
 Largura: 1,95 cm, altura: 1,95 cm  
 Largura máx. Led-strip em mm: 10  
 Não inclui difusor

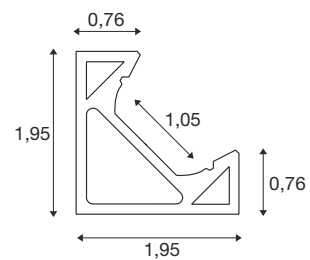
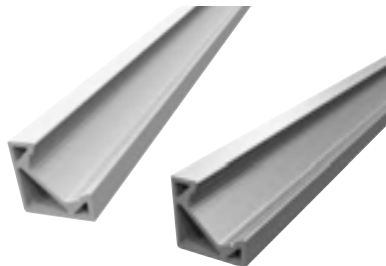

Comprimento (cm)	Cor	Material	Art. n.º	EUR
200	<input type="radio"/> Branco	Alumínio	1004890	39,00
	<input checked="" type="radio"/> Alumínio		1004889	39,00

# ACESSÓRIOS

## GRAZIA 10 EDGE Difusores



Descrição	Acabamento	Comprimento (cm)	Largura (cm)	Altura (cm)	Material	Art. n.º	EUR
Difusor	<input type="radio"/> Leitoso	200	1,58	0,4	Policarbonato (PC)	1000466	18,00
	<input type="radio"/> Fosco				Polimetilacrilato (PMMA)	1000468	24,00
	<input type="radio"/> Acetinado					1000469	24,00

## GRAZIA 10 EDGE Tampa



Descrição	Cor	Comprimento (cm)	Largura (cm)	Altura (cm)	Material	Art. n.º	EUR
Tampa	<input type="radio"/> Branco	2	0,7	2	ABS	1004894	2,25
	<input checked="" type="radio"/> Alumínio					1004893	2,25

Unidade embalada: 2 artigos

## GRAZIA 10 EDGE Acessórios de montagem



Descrição	Cor	Comprimento (cm)	Largura (cm)	Altura (cm)	Material	Art. n.º	EUR
Acess. fixação	<input checked="" type="radio"/> Aço inoxidável	2,25	15	2,25	Aço	1004895	4,25

Unidade embalada: 2 artigos



### GRAZIA 20

Perfil saliente, elevado, 3 m

Material: alumínio  
 Largura: 3,5 cm, altura: 3,2 cm  
 Largura Largura Led-strip em mm: 20  
 Não inclui difusor

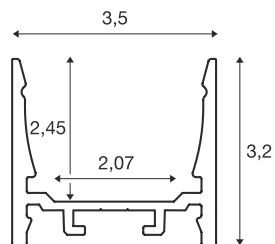

Comprimento (cm)	Cor	Material	Art. n.º	EUR
300	● Preto	Alumínio	1000525	89,00
	○ Branco		1000524	89,00

### GRAZIA 20

Perfil saliente, rebaixado, 3 m

Material: alumínio  
 Largura: 3,5 cm, altura: 2,2 cm  
 Largura Largura Led-strip em mm: 20  
 Não inclui difusor

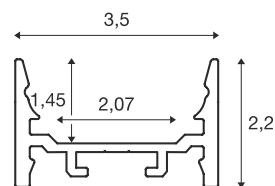

Comprimento (cm)	Cor	Material	Art. n.º	EUR
300	● Preto	Alumínio	1000534	75,00
	○ Branco		1000533	75,00

### GRAZIA 20

Perfil de encastrar, 3 m

Material: alumínio  
 Largura: 5,2 cm, altura: 3,2 cm  
 Largura Largura Led-strip em mm: 20  
 Não inclui cobertura

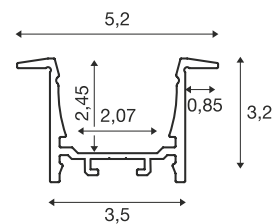

Comprimento (cm)	Cor	Material	Art. n.º	EUR
300	● Preto	Alumínio	1000498	105,00
	○ Branco		1000497	105,00

# ACESSÓRIOS

## GRAZIA 20 Difusor, 3 m



Descrição	Acabamento	Comprimento (cm)	Largura (cm)	Altura (cm)	Material	Art. n.º	EUR
Difusor	<input type="radio"/> Acetinado	300	3,2	0,6	Policarbonato (PC)	1000540	41,50
	<input type="radio"/> Fosco				Polimetilacrilato (PMMA)	1000546	41,50
	<input type="radio"/> Leitoso					1000549	41,50

## GRAZIA 20 Conector longitudinal



Descrição	Cor	Comprimento (cm)	Largura (cm)	Altura (cm)	Material	Art. n.º	EUR
União	<input checked="" type="radio"/> Alumínio	3,8	1,4	0,4	Alumínio	1000571	12,00

Unidade embalada: 2 artigos

## GRAZIA 20 Tampas para perfil saliente



Descrição	Cor	Comprimento (cm)	Largura (cm)	Altura (cm)	Material	Art. n.º	EUR
Tampa	<input checked="" type="radio"/> Preto, rebaixado	3,5	3,5	2,2	Alumínio	1000561	9,25
	<input type="radio"/> Branco, rebaixado					1000560	9,25
Tampa	<input checked="" type="radio"/> Preto, elevado	3,5	3,5	3,2	Alumínio	1000567	9,25
	<input type="radio"/> Branco, elevado					1000566	9,25

Unidade embalada: 2 artigos

**GRAZIA 20**  
Tampa para perfil de encastrar



Descrição	Cor	Comprimento (cm)	Largura (cm)	Altura (cm)	Material	Art. n.º	EUR
Tampa	<input checked="" type="radio"/> Preto		5,2	3,2	Alumínio	1000558	9,25
	<input type="radio"/> Branco					1000557	9,25

Unidade embalada: 2 artigos

**GRAZIA 20**  
Estrutura suspensa



Descrição	Cor	Comprimento (cm)	Material	Art. n.º	EUR
Estrutura suspensa	<input type="radio"/> Prateado	200	Aço	1000535	27,25

Unidade embalada: 2 artigos

**GRAZIA 20**  
Acessórios de montagem



Descrição	Cor	Comprimento (cm)	Largura (cm)	Altura (cm)	Material	Art. n.º	EUR
Acess. fixação	<input type="radio"/> Prateado		3	0,8	Aço	1000536	4,00
Molas	<input checked="" type="radio"/> Cromado/alumínio	5,5	7	2,3	Aço/alumínio	1004932	22,00

Unidade embalada: 2 artigos





## GRAZIA 60

Perfil saliente, 1,5 m

Material: alumínio  
 Largura: 7 cm, altura: 9,5 cm  
 Largura Led-strip em mm: 20  
 Não inclui difusor

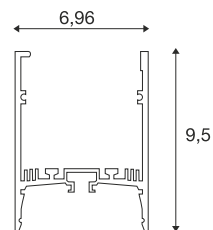
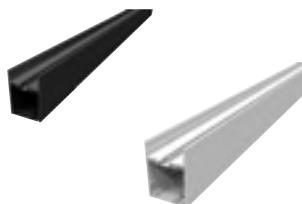

IP 20

Comprimento (cm)	Cor	Material	Art. n.º	EUR
150	● Preto	Alumínio	1004896	110,00
150	○ Branco		1004897	110,00
300	● Preto	Alumínio	1004898	220,00
300	○ Branco		1004899	220,00

O perfil de montagem correspondente e outros acessórios podem ser encontrados nas páginas 682-683

## GRAZIA 60

Perfil de encastrar, 1,5 m

Material: alumínio  
 Largura: 8,6 cm, altura: 3,3 cm  
 Largura Led-strip em mm: 20  
 Não inclui difusor

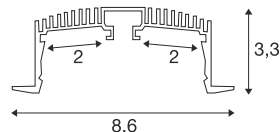
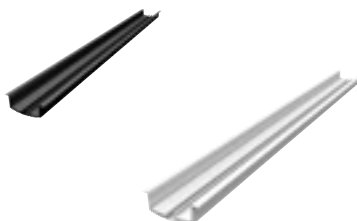

IP 20

Comprimento (cm)	Cor	Material	Art. n.º	EUR
150	● Preto	Alumínio	1004905	67,00
150	○ Branco		1004906	67,00
300	● Preto	Alumínio	1004907	133,00
300	○ Branco		1004908	133,00

# ACESSÓRIOS

## GRAZIA 60 Difusor



Descrição	Cor/Acabamento	Comprimento (cm)	Largura (cm)	Altura (cm)	Material	Art. n.º	EUR
	● Preto				Alumínio	1004912	29,00
	○ Branco					1004913	29,00
Difusor, 1,5m	○ Fosco	150	6,5	0,65	Policarbonato (PC)	1004914	18,00
	○ Fosco					Polimetilacrilato (PMMA)	1004916
Difusor, 3 m	○ Fosco	300	6,5	0,65	Policarbonato (PC)	1004915	35,00
	○ Fosco	300				Polimetilacrilato (PMMA)	1004917

## GRAZIA 60 Tampa



Descrição	Cor	Comprimento (cm)	Largura (cm)	Altura (cm)	Material	Art. n.º	EUR
Tampas perfil saliente	● Preto		7	9,5	Alumínio	1004900	12,50
	○ Branco					1004901	12,50
Tampas perfil encastrar	● Preto		8,6	3,3	Alumínio	1004909	8,50
	○ Branco					1004910	8,50

Unidade embalada: 2 artigos

## GRAZIA 60 Cobertura do perfil

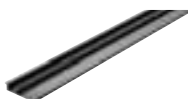

Descrição	Cor	Comprimento (cm)	Largura (cm)	Altura (cm)	Material	Art. n.º	EUR
Cobertura	● Preto	150	6,1	1,2	Alumínio	1004902	35,00

**GRAZIA 60**  
 Perfil saliente,  
 conectores longitudinais



Descrição	Cor	Comprimento (cm)	Largura (cm)	Altura (cm)	Material	Art. n.º	EUR
União	● Alumínio	8	4,2	1	Alumínio	1004903	12,00

**GRAZIA 60**  
 Perfil saliente, alimentador



Descrição	Cor	Comprimento (cm)	Largura (cm)	Altura (cm)	Material	Art. n.º	EUR
Alimentador	● Alumínio	8	4,2	2,4	Alumínio	1004904	13,00

**GRAZIA 60**  
 Perfil de encastrar,  
 acessório para teto falso



Descrição	Cor	Comprimento (cm)	Largura (cm)	Altura (cm)	Material	Art. n.º	EUR
Ac. Encastrar	● Cromado	13	2,8	4	Alumínio	1004911	15,25

# CRIE O SEU PERFIL LED

Dê o seu toque pessoal ou ilumine salas inteiras –  
Possibilidade desde 700 lm por metro até 4000 lm por metro

Adicione cor – Led-strip disponível nas versões branco,  
CCT (Tunable White) ou RGBW.

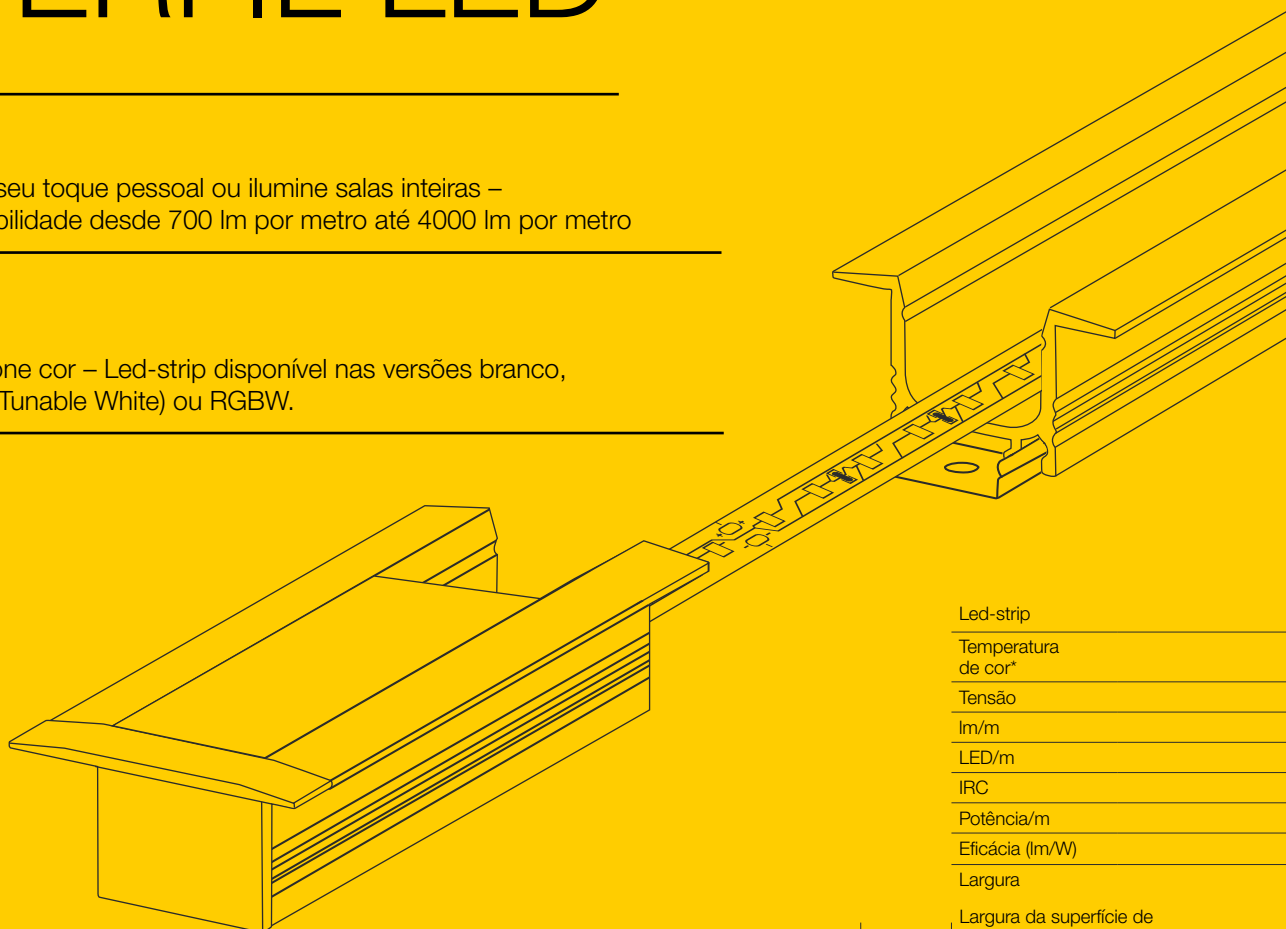

Led-strip

Temperatura  
de cor\*

Tensão

lm/m

LED/m

IRC

Potência/m

Eficácia (lm/W)

Largura

Largura da superfície de  
montagem do led-strip

Perfis		Cor	
GRAZIA 10 Perfil saliente, rebaixado, 2 m	1000462	Preto	10mm
	1000461	Branco	
GRAZIA 10 Perfil saliente, elevado, 2 m	1000465	Preto	10mm
	1000464	Branco	
GRAZIA 10 Perfil de encastrar, 2 m	1000459	Preto	10mm
	1000458	Branco	
GRAZIA 10 Edge, 2 m	1004889	alu	10mm
	1004890	Branco	
GRAZIA 20 Perfil saliente, elevado, 3 m	1000525	Preto	20mm
	1000524	Branco	
GRAZIA 20 Perfil saliente, rebaixado, 3 m	1000534	Preto	20mm
	1000533	Branco	
GRAZIA 20 Perfil de encastrar 3 m	1000498	Preto	20mm
	1000497	Branco	
GRAZIA 60 Perfil saliente 1,5 m	1004896	Preto	40mm
	1004897	Branco	
GRAZIA 60 Perfil saliente 3 m	1004898	Preto	40mm
	1004899	Branco	
GRAZIA 60 Perfil de encastrar 1,5 m	1004905	Preto	40mm
	1004906	Branco	
GRAZIA 60 Perfil de encastrar 3 m	1004908	Preto	40mm
	1004907	Branco	

Foscas, leitosas ou transparentes, versão lisa ou subelevada – Escolha entre diferentes coberturas para diferentes aplicações e distribuições da luz.

Todos os componentes visíveis do sistema são coordenados por cores. As tampas metálicas das extremidades são revestidas com o mesmo pó dos perfis.

A superfície de montagem das tiras dos perfis não é revestida a pó para permitir a perfeita dissipação do calor.

<b>NEW</b> Grazia LED Strip Value, Additional Lighting	<b>NEW</b> Grazia LED Strip Value, Main Lighting	<b>NEW</b> Grazia LED Strip Value, Main Lighting Plus	<b>NEW</b> Grazia LED Strip Core, Main Lighting	Grazia LED Strip Pro MAX	Grazia LED Strip Pro MAX Performance
1008380	1008516	1008519	1008522	1004720	1004722
3000K	3000K	3000K	3000K	3000K	3000K
24V	24V	24V	24V	24V	24V
670	1340	2040	1620	2500	4000
64	128	160	180	196	196
>80	>80	>80	>90	>90	>90
4,8W	9,6W	14,4W	9W	25,2W	38,6W
140	140	140	180	99	104
8mm	8mm	8mm	8mm	20mm	20mm
✓	✓	✓	✓	-	-
✓	✓	✓	✓	-	-
✓	✓	✓	✓	-	-
✓	✓	✓	✓	-	-
✓	✓	✓	✓	✓	✓
✓	✓	✓	✓	-	-
✓	✓	✓	✓	✓	✓
✓	✓	✓	✓	✓	✓
✓	✓	✓	✓	✓	✓
✓	✓	✓	✓	✓	✓
✓	✓	✓	✓	✓	✓

\* Disponível noutras cores de luz



## GRAZIA LED STRIP VALUE

### Additional Lighting

LED por metro: 164  
 Largura: 0,8 cm  
 Altura: 0,14 cm  
 Distância entre os LED: 1,563 cm  
 Separável a cada: 12,5 cm  
 Código IP: IP20  
 Ambas as extremidades incluem 50 cm de cabo de alimentação

NEW



Temperatura de cor (K)	Fluxo luminoso (lm)	Potência (W)	Índice de reprodução de cores (IRC)	Consistência da cor	Comprimento (cm)	Art. n.º	EUR
2700	3300	24				1008379	
3000	3350	24	80	3	500	1008380	54,00
4000	3450	24				1008381	

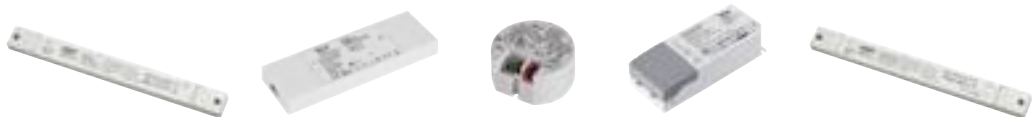

⊕

Artigo	Material	Comprimento (cm)	Largura (cm)	Altura (cm)	Art. n.º	EUR
○ Transformador LED   30 W, 24 VDC fino	Polícarbonato (PC)	30	3	1.6	1007250	50,00
○ Transformador LED   36 W, 24 VDC plano	Polícarbonato (PC)	17	5.7	1.8	1008654	55,00
○ Transformador LED   25 W, 24 VDC Instalação da tomada	Polícarbonato (PC)		Ø 5.5	2.5	1008652	27,00
○ Transformador LED   25 W, 24 VDC PHASECUT	Polícarbonato (PC)	12.8	5.2	3	1006336	35,00
○ Transformador LED   30 W, 24 VDC slim DALI	Polícarbonato (PC)	30	3	1.6	1007254	60,00



## GRAZIA LED STRIP VALUE

### Main Lighting

LED por metro: 128  
 Largura: 0,8 cm  
 Altura: 0,14 cm  
 Distância entre os LED: 0,781 cm  
 Separável a cada: 6,25 cm  
 Código IP: IP20  
 Ambas as extremidades incluem 50 cm de cabo de alimentação



Temperatura de cor (K)	Fluxo luminoso (lm)	Potência (W)	Índice de reprodução de cores (IRC)	Consistência da cor	Comprimento (cm)	Art. n.º	EUR
2700	6600	48	80	3	500	1008515	114,00
3000	6700	48				1008516	
4000	6950	48				1008517	

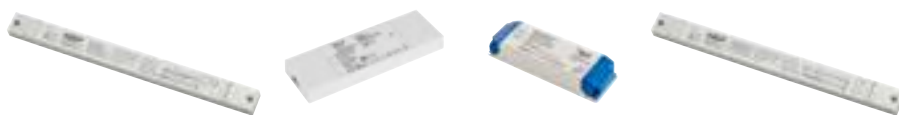

Artigo	Material	Comprimento (cm)	Largura (cm)	Altura (cm)	Art. n.º	EUR
○ Transformador LED   100 W, 24 VDC fino	Policarbonato (PC)	35	3	1.8	1007251	80,00
○ Transformador LED   60 W, 24 VDC plano	Policarbonato (PC)	17	5.7	1.8	1008655	65,00
○ Transformador LED   50 W, 24 VDC PHASECUT	Policarbonato (PC)	18.4	6.1	3.2	1003104	49,50
○ Transformador LED   100 W, 24 VDC slim DALI	Policarbonato (PC)	35	3	1.8	1007255	110,00

Para garantir a dissipação de calor, as LED-strip devem ser coladas num perfil de alumínio. A LED-strip inclui fita adesiva na sua parte traseira.



## GRAZIA LED STRIP VALUE

### Main Lighting +

LED por metro: 160  
 Largura: 1 cm  
 Altura: 0,14 cm  
 Distância entre os LED: 0,625 cm  
 Separável a cada: 5 cm  
 Código IP: IP20  
 Ambas as extremidades incluem 50 cm de cabo de alimentação

NEW



Temperatura de cor (K)	Fluxo luminoso (lm)	Potência (W)	Índice de reprodução de cores (IRC)	Consistência da cor	Comprimento (cm)	Art. n.º	EUR
2700	10050	72	80	3	500	1008518	129,00
3000	10200	72				1008519	
4000	10450	72				1008520	



⊕

Artigo	Material	Comprimento (cm)	Largura (cm)	Altura (cm)	Art. n.º	EUR
○ Transformador LED   100 W, 24 VDC fino	Polícarbonato (PC)	35	3	1.8	1007251	80,00
○ Transformador LED   100 W, 24 VDC PHASECUT	Polícarbonato (PC)	21	6.7	3.4	1003105	121,00
○ Transformador LED   100 W, 24 VDC slim DALI	Polícarbonato (PC)	35	3	1.8	1007255	110,00



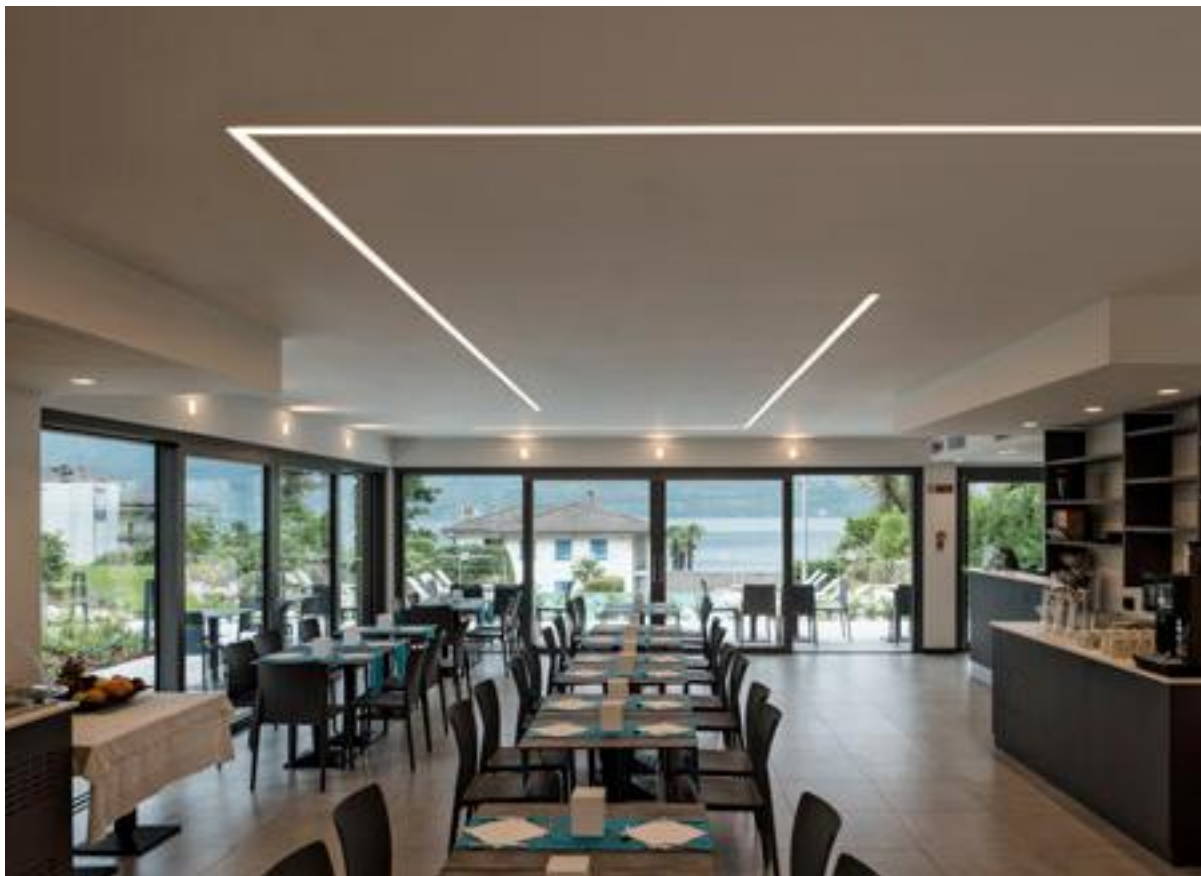

## GRAZIA LED STRIP CORE Main Lighting

LED por metro: 180  
 Largura: 1 cm  
 Altura: 0,14 cm  
 Distância entre os LED: 0,556 cm  
 Separável a cada: 5 cm  
 Código IP: IP20  
 Ambas as extremidades incluem 50 cm de cabo de alimentação



Temperatura de cor (K)	Fluxo luminoso (lm)	Potência (W)	Índice de reprodução de cores (IRC)	Consistência da cor	Comprimento (cm)	Art. n.º	EUR
2700	8000	45	90	3	500	1008521	199,00
3000	8100	45				1008522	
4000	8500	45				1008523	
6500	8500	45				1008524	

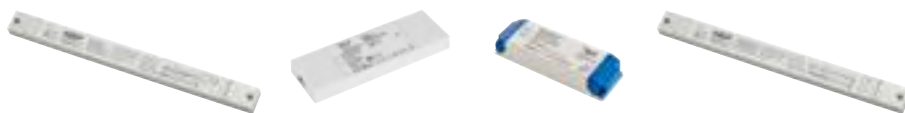

Artigo	Material	Comprimento (cm)	Largura (cm)	Altura (cm)	Art. n.º	EUR
○ Transformador LED   100 W, 24 VDC fino	Polycarbonato (PC)	35	3	1.8	1007251	80,00
○ Transformador LED   60 W, 24 VDC plano	Polycarbonato (PC)	17	5.7	1.8	1008655	65,00
○ Transformador LED   50 W, 24 VDC PHASECUT	Polycarbonato (PC)	18.4	6.1	3.2	1003104	49,50
○ Transformador LED   100 W, 24 VDC slim DALI	Polycarbonato (PC)	35	3	1.8	1007255	110,00

Para garantir a dissipação de calor, as LED-strip devem ser coladas num perfil de alumínio. A LED-strip inclui fita adesiva na sua parte traseira.



## GRAZIA PRO MAX FLEXSTRIP 24V

LED por metro: 196  
 Largura: 2 cm  
 Altura: 0,15 cm  
 Distância entre os LED: 0,5 cm  
 Separável a cada: 3,6 cm  
 Código IP: IP 20  
 Ambos os lados com 20 cm de cabo de alimentação

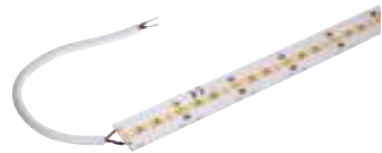

Temperatura de cor (K)	Fluxo luminoso (lm)	Potência (W)	Índice de reprodução de cores (IRC)	Consistência da cor	Comprimento (cm)	Art. n.º	EUR
3000	12500	126	90	3	500	1004720	199,00
4000	13000	126				1004721	



Artigo	Material	Comprimento (cm)	Largura (cm)	Altura (cm)	Art. n.º	EUR
<input type="radio"/> Transformador LED   150 W, Slim Line, ligado/desligado	Policarbonato (PC)	35	3	1.8	1007252	100,00
<input type="radio"/> Transformador LED   150 W, Slim Line, DALI	Policarbonato (PC)	35	3	1.8	1007256	140,00



## GRAZIA PRO MAX FLEXSTRIP 24V

LED por metro: 196  
 Largura: 2 cm  
 Altura: 0,15 cm  
 Distância entre os LED: 1 cm  
 Separável a cada: 7,1 cm  
 Código IP: IP 20  
 Ambos os lados com 20 cm de cabo de alimentação



Temperatura de cor (K)	Fluxo luminoso (lm)	Potência (W)	Índice de reprodução de cores (IRC)	Consistência da cor	Comprimento (cm)	Art. n.º	EUR
3000	20000	193	90	3	500	1004722	350,00
4000	21400	192.9				1004723	



Artigo	Material	Comprimento (cm)	Largura (cm)	Altura (cm)	Art. n.º	EUR
○ Transformador LED   250W, Slim, on/off	Policarbonato (PC)	40	4	2.2	1007253	120,00
○ Transformador LED   250W, Slim, DALI	Policarbonato (PC)	40	4	2.2	1007257	160,00

Para garantir a dissipação de calor, as LED-strip devem ser coladas num perfil de alumínio. A LED-strip inclui fita adesiva na sua parte traseira.



## GRAZIA PRO FLEXSTRIP

tunable white, 24 V

LED por metro: 224  
 Largura: 1 cm  
 Altura: 0,12 cm  
 Distância entre os LED: 0,9 cm  
 Separável a cada: 6,3 cm  
 Código IP: IP 20  
 Ambos os lados com cabo de alimentação



Temperatura de cor (K)	Fluxo luminoso (lm)	Potência (W)	Índice de reprodução de cores (IRC)	Consistência da cor	Comprimento (cm)	Art. n.º	EUR
2700-6500	3400	80	90	6	500	1004725	153,00



⊕

Artigo	Material	Comprimento (cm)	Largura (cm)	Altura (cm)	Art. n.º	EUR
○ Controlador DALI   1 canal, push-dim	Policarbonato (PC)	11.6	4.2	1.8	1003106	64,00
○ Controlador DALI DT8   5 CH, push	Policarbonato (PC)	17	5.9	2.9	1007997	120,00
○ Controlador SMART   1-5 canais	Policarbonato (PC)	14.5	4.65	1.6	1006348	80,00
○ Controlp remoto SMART   Zigbee	Policarbonato (PC)	14	4.4	1.7	1007827	79,00
○ Transformador LED   60 W, DALI, 2 CH	Policarbonato (PC)	20.2	5.8	3	1006133	153,00
○ Transformador LED   100W, Slim, on/off	Policarbonato (PC)	35	3	1.8	1007251	80,00
○ Transformador LED   100W, Slim, DALI	Policarbonato (PC)	35	3	1.8	1007255	110,00



## GRAZIA PRO FLEXSTRIP RGBW, 24V

LED por metro: 70  
 Largura: 1,2 cm  
 Altura: 0,22 cm  
 Distância entre os LED: 1,4 cm  
 Separável a cada: 10 cm  
 Código IP: IP 20  
 Ambos os lados com cabo de alimentação



Temperatura de cor (K)	Fluxo luminoso (lm)	Potência (W)	Índice de reprodução de cores (IRC)	Consistência da cor	Comprimento (cm)	Art. n.º	EUR
3000	2050	26.9	90	6	500	1004727	155,00



Artigo	Material	Comprimento (cm)	Largura (cm)	Altura (cm)	Art. n.º	EUR
<input type="radio"/> Controlador DALI DT8   5 canais, push-dim	Policarbonato (PC)	17	5.9	2.9	1007997	120,00
<input type="radio"/> Controlador SMART   1-5 canais	Policarbonato (PC)	14.5	4.65	1.6	1006348	80,00
<input type="radio"/> Controlo remoto SMART   Zigbee	Policarbonato (PC)	14	4.4	1.7	1007827	79,00
<input type="radio"/> Transformador LED   100 W, Slim, on/off	Policarbonato (PC)	35	3	1.8	1007251	80,00

Para garantir a dissipação de calor, as LED-strip devem ser coladas num perfil de alumínio. A LED-strip inclui fita adesiva na sua parte traseira.



## GRAZIA IP FLEXSTRIP 24V

LED por metro: 70  
 Largura: 1,2 cm  
 Altura: 0,4 cm  
 Distância entre os LED: 1,4 cm  
 Separável a cada: 10 cm  
 Código IP: IP 54  
 Ambos os lados com cabo de alimentação



Temperatura de cor (K)	Fluxo luminoso (lm)	Potência (W)	Índice de reprodução de cores (IRC)	Consistência da cor	Comprimento (cm)	Art. n.º	EUR
2700	3363	43.8				1004734	
3000	3363	43.8	90	4	502	1004735	99,00
4000	3614	43.8				1004736	

## GRAZIA IP FLEXSTRIP tunable white, 24 V

LED por metro: 224  
Largura: 1,2 cm  
Altura: 0,4 cm  
Distância entre os LED: 0,9 cm  
Separável a cada: 6,3 cm  
Código IP: IP66  
Ambos os lados com cabo de alimentação



Temperatura de cor (K)	Fluxo luminoso (lm)	Potência (W)	Índice de reprodução de cores (IRC)	Consistência da cor	Comprimento (cm)	Art. n.º	EUR
2700-6500	3223	80,3	90	4	502	1004726	170,00



Artigo	Material	Comprimento (cm)	Largura (cm)	Altura (cm)	Art. n.º	EUR
<input type="radio"/> Controlador DALI DT8   5 canais, push-dim	Policarbonato (PC)	17	5.9	2.9	1007997	120,00
<input type="radio"/> Controlador SMART   1-5 canais	Policarbonato (PC)	14,5	4,65	1,6	1006348	80,00
<input type="radio"/> Controlo remoto SMART   Zigbee	Policarbonato (PC)	14	4,4	1,7	1007827	79,00
<input type="radio"/> Transformador LED   60 W, DALI, 2 canais	Policarbonato (PC)	20,2	5,8	3	1006133	153,00
<input type="radio"/> Transformador LED   100 W, DALI, 2 canais	Policarbonato (PC)	34,7	4	2,2	1006134	184,00
<input type="radio"/> Transformador LED   150 W, Slim Line, ligado/desligado	Policarbonato (PC)	35	3	1,8	1007252	100,00

## GRAZIA IP FLEXSTRIP RGBW, 24V

LED por metro: 70  
Largura: 1,4 cm  
Altura: 0,46 cm  
Distância entre os LED: 1,4 cm  
Separável a cada: 10 cm  
Código IP: IP 54  
Ambos os lados com cabo de alimentação



Temperatura de cor (K)	Fluxo luminoso (lm)	Potência (W)	Índice de reprodução de cores (IRC)	Consistência da cor	Comprimento (cm)	Art. n.º	EUR
3000	1958	27	90	6	502	1004737	210,00



Artigo	Material	Comprimento (cm)	Largura (cm)	Altura (cm)	Art. n.º	EUR
<input type="radio"/> Controlador DALI DT8   5 canais, push-dim	Policarbonato (PC)	17	5.9	2.9	1007997	120,00
<input type="radio"/> Controlador SMART   1-5 canais	Policarbonato (PC)	14,5	4,65	1,6	1006348	80,00
<input type="radio"/> Controlo remoto SMART   Zigbee	Policarbonato (PC)	14	4,4	1,7	1007827	79,00

Para garantir a dissipação de calor, as LED-strip devem ser coladas num perfil de alumínio. A LED-strip inclui fita adesiva na sua parte traseira.



1006380 + 1006394 729 + 726





 <p><b>LED</b> SUN GRID   701</p>	 <p><b>LED</b> GRID CUBE   701</p>	 <p><b>LED</b> VINOLINA ONE   703</p>	 <p><b>LED</b> VINOLINA   703</p>	 <p><b>LED</b> VINOLINA TWO   705</p>	 <p><b>LED</b> TAHA   707</p>
 <p><b>SCKET</b> S-TUBE 32/75   709</p>	 <p><b>SCKET</b> PHOTONI CYL   711</p>	 <p><b>SCKET</b> PHOTONI 45/75   713</p>	 <p><b>LED</b> S-CUBE 35/75   714</p>	 <p><b>LED</b> R-CUBE 35/75   715</p>	 <p><b>LED</b> ADEGAN   717</p>
 <p><b>LED</b> ADEGAN   717</p>	 <p><b>LED</b> I-RING   718</p>	 <p><b>LED</b> LID   45/75   719</p>	 <p><b>LED</b> M-POL S   720</p>	 <p><b>LED</b> M-POL S   721</p>	 <p><b>LED</b> M-POL S   722</p>
 <p><b>LED</b> M-POL S   723</p>	 <p><b>LED</b> M-POL S   724</p>	 <p><b>LED</b> M-POL M   725</p>	 <p><b>LED</b> M-POL M   726</p>	 <p><b>LED</b> M-POL M   727</p>	 <p><b>LED</b> M-POL 30/60/90   728, 729</p>
 <p><b>SCKET</b> CONCRETO   733</p>	 <p><b>SCKET</b> CONCRETO   733</p>	 <p><b>LED</b> RASTERLYS   735</p>	 <p><b>LED</b> ESKINA FRAME 45/75   737</p>	 <p><b>LED</b> ESKINA FRAME 75   737</p>	 <p><b>LED</b> ESKINA FRAME 125/175   738</p>
 <p><b>LED</b> ESKINA 30/80   739</p>	 <p><b>SCKET</b> T-TUBE 70   740, 741</p>	 <p><b>SCKET</b> T-TUBE 70   740, 741</p>	 <p><b>LED</b> LOGS 40/70   743</p>	 <p><b>SCKET</b> GRAFIT 30/60/90   745</p>	 <p><b>SCKET</b> GRAFIT 30/60/90   747</p>
 <p><b>LED</b> QUADRULO   749</p>	 <p><b>LED</b> RUSTY® SLOT 50/80   750</p>	 <p><b>SCKET</b> RUSTY® SLOT 50/80   751</p>	 <p><b>SCKET</b> RUSTY® PATHLIGHT   752</p>	 <p><b>LED</b> RUSTY® PATHLIGHT 40/70   753</p>	 <p><b>LED</b> RUSTY® 40/70   755</p>



**SCKET**  
RUSTY® 40/70 | 697



**SCKET**  
RUSTY®  
CONE 24 | 757



**SCKET**  
RUSTY®  
CONE 40/70 | 757



**SCKET**  
RUSTY® 40/70 | 758



**SCKET**  
ARROCK  
GRANITE 40/70 | 759



**SCKET**  
ARROCK ARC | 760



**LED**  
ARROCK  
STONE 50/75 | 761



**SCKET**  
ARROCK SLOT | 761



**LED**  
L-LINE OUT  
30 | 762



**LED**  
L-LINE OUT  
60 | 763



**LED**  
L-LINE OUT  
50/80 | 763



**SCKET**  
THEO  
PATHLIGHT | 764



**LED**  
OVALISK 75/100 | 765



**SCKET**  
GLOO PURE  
27/44/70 | 767



**SCKET**  
ROTOBALL  
25/40/50 | 769



**SCKET**  
PHOTONIA | 771



**SCKET**  
OTOS GLAS | 771



**SCKET**  
CUBIX | 772



**SCKET**  
CONE | 772



**SCKET**  
MOLAT | 773



**SCKET**  
MOLAT | 773



**SCKET**  
LISENNE 40/70 | 774



**SCKET**  
ADEGAN | 775



**SCKET**  
ALPA MUSHROOM  
45/75 | 777



**SCKET**  
ALPA CONE 100 | 777



**LED**  
APONI 90/120 | 778



**LED**  
TRUST 30/60 | 779



**SCKET**  
BIG NAILS 50/80 | 780



**SCKET**  
ROX ACRYL  
30/60/90 | 781



**SCKET**  
VAP SLIM  
30/60/90 | 783



**SCKET**  
C-POL | 784



**SCKET**  
F-POL | 784



**SCKET**  
SQUARE POLE  
30/60/90 | 785



**LED**  
SLOTS 45/65 | 787

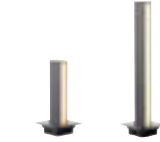

**LED**  
H-POL 30/60 | 788



**LED**  
H-POL TWIN 60 | 789



LED

SLOTBOX 40/60 | 791



LED

FLATT 65/100 | 793



LED

ORDI II | 795

NEW



LED

ORDI II | 795

NEW



LED

ABRIDOR 60/100 | 796

NEW



LED

ABRIDOR 60/100 | 797



LED

IPERI 50 | 798



SCKET

QUADRASYL 75 | 799



LED

QUAD POLE | 800



LED

BOOKAT | 800



SCKET

MYRA SPOT | 801



SCKET

SITRA 360 | 801



1008477 701



1008476 701



## SUN GRID

A partir da primavera de 2025



## GRID CUBE

A partir da primavera de 2025

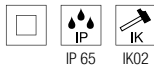

IP 65 IK02

220-240V ~50/60Hz  
Potência do sistema: 8W  
Material: policarbonato (PC)



Down

2700K

Versão	Art. n.º	EUR
● Preto	1008476	● 179,00

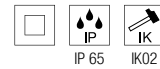

IP 65 IK02

220-240V ~50/60Hz  
Potência do sistema: 8W  
Material: policarbonato (PC)



Down

2700K

Versão	Art. n.º	EUR
● Preto	1008477	● 199,00

1007357 703



1007360 703





## VINOLINA ONE TL, Bateria

## VINOLINA TL, Bateria

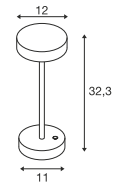
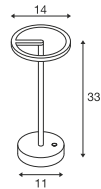

Funcionamento a bateria de 5V  
Potência do sistema: 2,5W  
Material: alumínio

Funcionamento a bateria de 5V  
Potência do sistema: 2,2W  
Material: alumínio

- Duração 12h
- Tempo de carregamento 7h
- Inclui placa de carregamento
- Não inclui fonte de alimentação
- USB A

- Duração 12h
- Tempo de carregamento 7h
- Inclui placa de carregamento
- Não inclui fonte de alimentação
- USB A



Down 125lm | 2700K

Down 130lm | 2700K | 130lm | 3000K

Versão	Art. n.º	EUR
● Preto	1007359	99,00
○ Branco	1007357	99,00
● Oxidado	1007358	99,00

Versão	Art. n.º	EUR
● Preto	1007362	99,00
○ Branco	1007360	99,00
● Oxidado	1007361	99,00



1007697 705

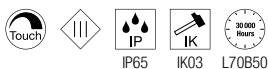
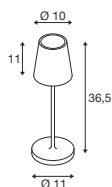

VINOLINA TWO  
TL, Bateria, DTW

Funcionamento a bateria de 5V  
Potência do sistema: 2W  
Material: alumínio/plástico

- Duração 10h
- Tempo de carregamento 5h
- Inclui estação de carregamento para uma luminária



140lm | 2200K | 170lm | 2700K | 190lm | 3000K

Versão	Art. n.º	EUR
● Preto	1007693	99,00
○ Branco	1007692	99,00
● Areia	1007697	99,00
● Oxidado	1007695	99,00
● Vermelho	1007694	99,00
● Verde-limão	1007696	99,00

VINOLINA TWO  
Base de carregamento

NEW

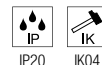

220-240V ~50/60Hz | 5V  
Potência do sistema: 37W  
Material: plástico/plástico

C: 46,2 cm  
L: 32,6 cm  
A: 5 cm

- Base de carregamento para máx. 6 VINOLINA TWO
- Cabo de ligação disponível em separado

Versão	Art. n.º	EUR
● Preto	1007698	139,00

VINOLINA TWO  
Cabo de ligação com ficha de segurança

NEW

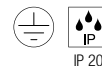

C: 180 cm

Versão	Art. n.º	EUR
● Preto	1008029	14,90



1007380 707



1007380 707



## TAHA

Conjunto de luminárias, BATERIA

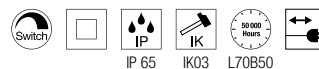
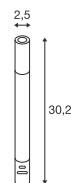

100-240V ~50/60Hz | Funcionamento a bateria de 5V  
 Potência do sistema: 5W  
 Máx. Controlador com saída em U: 5V DC  
 Material: alumínio/plástico

- 3 níveis reguláveis
- Transformador de tomada



Down

200lm | 2700K

Versão	Art. n.º	EUR
● Preto	1007380	159,00



1007651 709

1007652 709



### S-TUBE 32 Pole, GU10

### S-TUBE 75 Pole, GU10

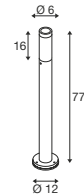
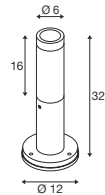

220-240V ~50/60Hz  
Material: alumínio

220-240V ~50/60Hz  
Material: alumínio

- Extremidade do cabo aberta

- Extremidade do cabo aberta



Casquilho: 1xGU10 máx. Ø: 5 cm | C: 5,5 cm

Casquilho: 1xGU10 máx. Ø: 5 cm | C: 5,5 cm

Versão	Art. n.º	EUR
● Preto	1007651	84,00

Versão	Art. n.º	EUR
● Preto	1007652	134,00



LED GU10 51 mm | 6W | 38°  
2700K | 450lm | CEE=F  
6 kWh/1000h



Art. N.º: 1005077 | 7,50 EUR



LED GU10 51 mm | 6W | 38°  
2700K | 450lm | CEE=F  
6 kWh/1000h



Art. N.º: 1005077 | 7,50 EUR



Artigo	Art. n.º	EUR
Caixa de ligação IP68 3 polos	228730	18,00
● Preto		



Artigo	Art. n.º	EUR
Caixa de ligação IP68 3 polos	228730	18,00
● Preto		



1008194 711



PHOTONI CYL  
Pole 45

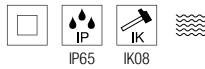
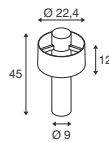

220-240V ~50/60Hz  
Material: alumínio

- Caixa de ligação IP



Casquilho: 1xE27 máx. Ø: 6 cm | C: 11,6 cm

Versão	Art. n.º	EUR
● Preto	1008195	179,00
● Oxidado	1008196	179,00



LED A60 | 7,5W | 180°  
2700K | 720lm | CEE=F  
8 kWh/1000h



Art. N.º: 1005305 | 19,00 EUR

PHOTONI CYL  
Pole 75

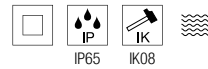
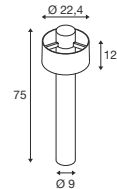

220-240V ~50/60Hz  
Material: alumínio

- Caixa de ligação IP



Casquilho: 1xE27 máx. Ø: 6 cm | C: 11,6 cm

Versão	Art. n.º	EUR
● Preto	1008193	199,00
● Oxidado	1008194	199,00



LED A60 | 7,5W | 180°  
2700K | 720lm | CEE=F  
8 kWh/1000h



Art. N.º: 1005305 | 19,00 EUR



1007587 713

1007584 713





## PHOTONI 45

Pole, E27

## PHOTONI 75

Pole, E27

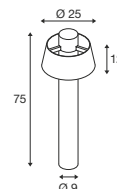
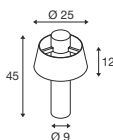

IP65 IK08

220-240V ~50/60Hz  
Material: alumínio

- Caixa estanque IP com 3 polos



IP65 IK08

220-240V ~50/60Hz  
Material: alumínio

- Caixa estanque IP com 3 polos



Casquilho: 1xE27 máx. Ø: 6 cm | C: 11,6 cm

Versão	Art. n.º	EUR
● Preto	1007587	179,00
● Oxidado	1007583	179,00



A60 | 7,5W | 180°  
2700K | 720lm | CEE=F  
8 kWh/1000h



Art. N.º: 1005305 | 19,00 EUR



Casquilho: 1xE27 máx. Ø: 6 cm | C: 11,6 cm

Versão	Art. n.º	EUR
● Preto	1007584	199,00
● Oxidado	1007580	199,00



A60 | 7,5W | 180°  
2700K | 720lm | CEE=F  
8 kWh/1000h



Art. N.º: 1005305 | 19,00 EUR

## S-CUBE 35 Pole

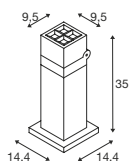

220-240V ~50/60Hz | 350mA  
Potência do sistema: 15W  
Material: alumínio

- Extremidade do cabo aberta



Down 1000lm | 2700K | 1200lm | 3000K

Versão	Art. n.º	EUR
● Antracite	1007460	199,00



Artigo	Art. n.º	EUR
Caixa de ligação IP68 3 polos		
● Preto	228730	18,00

## S-CUBE 75 Pole

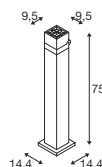

220-240V ~50/60Hz | 350mA  
Potência do sistema: 15W  
Material: alumínio

- Extremidade do cabo aberta



Down 1000lm | 2700K | 1200lm | 3000K

Versão	Art. n.º	EUR
● Antracite	1007459	234,00



Artigo	Art. n.º	EUR
Caixa de ligação IP68 3 polos		
● Preto	228730	18,00

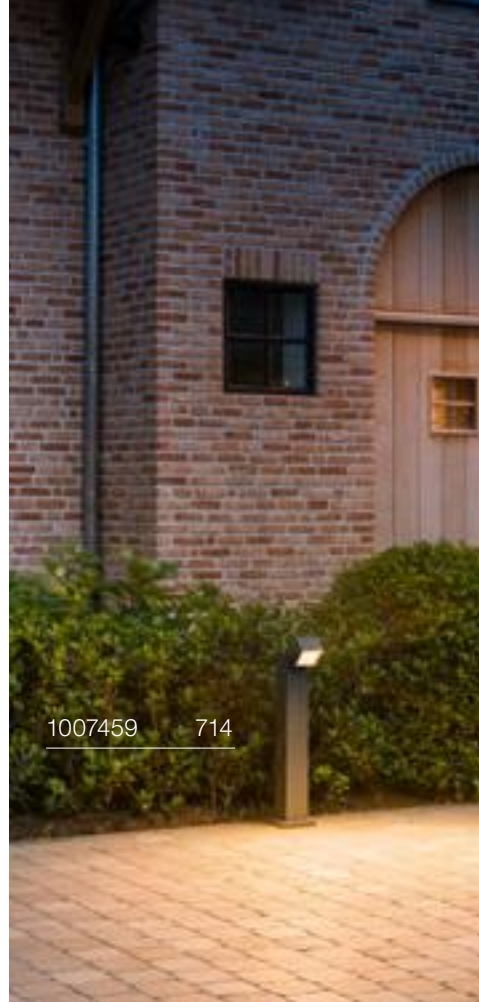

1007459 714





R-CUBE 35  
Pole

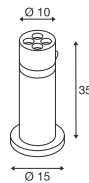

R-CUBE 75  
Pole

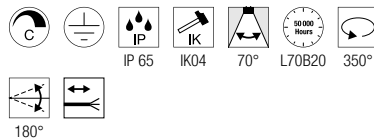
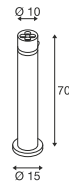

220-240V ~50/60Hz | 350mA  
Potência do sistema: 15W  
Material: alumínio

- Extremidade do cabo aberta



Down 800lm | 2700K | 800lm | 3000K

Versão	Art. n.º	EUR
● Antracite	1007513	199,00



Artigo	Art. n.º	EUR
Caixa de ligação IP68 3 polos		
● Preto	228730	18,00

1007513 715

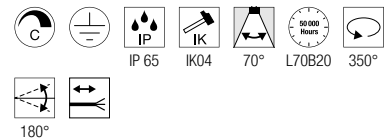

220-240V ~50/60Hz | 350mA  
Potência do sistema: 15W  
Material: alumínio

- Extremidade do cabo aberta



Down 800lm | 2700K | 800lm | 3000K

Versão	Art. n.º	EUR
● Antracite	1007512	234,00



Artigo	Art. n.º	EUR
Caixa de ligação IP68 3 polos		
● Preto	228730	18,00



1008389 717



### ADEGAN FL, SOLAR



A partir da primavera de 2025

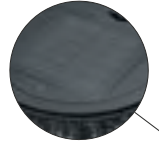

### ADEGAN FL, FLAT SOLAR



A partir da primavera de 2025

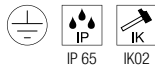
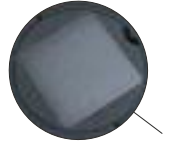

220-240V ~50/60Hz  
Material: polietileno (PE)



Down 550lm | 2200K

Versão	Art. n.º	EUR
● Preto	1008386	379,00
● Castanho	1008387	379,00

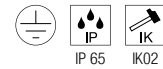

220-240V ~50/60Hz  
Material: polietileno (PE)



Down 550lm | 2200K

Versão	Art. n.º	EUR
● Preto	1008388	289,00
● Castanho	1008389	289,00

# I-RING Pole

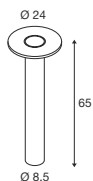

100-240V ~50/60Hz | 350mA  
 Potência do sistema: 9,2W  
 Material: alumínio

- Caixa de ligação IP68 de 3 polos



Down 670lm | 3000K

Versão	Art. n.º	EUR
● Antracite	1007237	229,00

⊕

Artigo	Art. n.º	EUR
Jogo de parafusos		
● Aço inoxidável	228753	9,25



1007237 718



1007669 719



LID I 45  
Pole, single

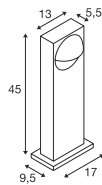

220-240V ~50/60Hz | 350mA  
Potência do sistema: 15W  
Material: alumínio

- Extremidade do cabo aberta



Down 900lm | 2700K | 1050lm | 3000K

Versão	Art. n.º	EUR
● Antracite	1007670	219,00



Artigo	Art. n.º	EUR
Caixa de ligação IP68 3 polos		
● Preto	228730	18,00

LID I 75  
Pole, double

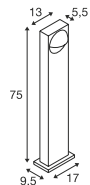

220-240V ~50/60Hz | 700mA  
Potência do sistema: 29W  
Material: alumínio

- Extremidade do cabo aberta



Down 850lm | 2700K | 1000lm | 3000K

Versão	Art. n.º	EUR
● Antracite	1007669	299,00



Artigo	Art. n.º	EUR
Caixa de ligação IP68 3 polos		
● Preto	228730	18,00

M-POL S  
Polehead 360°,  
Ofuscamento eliminado

M-POL S  
Polehead 360°,  
Ofuscamento eliminado, DALI

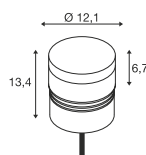
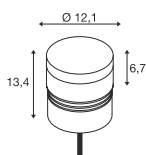

220-240V ~50/60Hz | 500mA  
Potência do sistema: 10W  
Material: alumínio

- Extremidade do cabo aberta
- Encontra o corpo da luminária e outros acessórios adequados nas páginas 728-729

220-240V ~50/60Hz | 500mA  
Potência do sistema: 10W  
Material: alumínio

- Extremidade do cabo aberta
- Encontra o corpo da luminária e outros acessórios adequados nas páginas 728-729



Down 750lm | 2700K

Versão	Art. n.º	EUR
● Antracite	1007232	290,00



Artigo	Art. n.º	EUR
Âncora de chão		
● Aço inoxidável	1006382	49,00
Caixa de conector em T		
● Preto	228726	33,00
Caixa de ligação IP68 3 polos		
● Preto	228730	18,00



Down 750lm | 2700K

Versão	Art. n.º	EUR
● Antracite	1007233	310,00



Artigo	Art. n.º	EUR
Âncora de chão		
● Aço inoxidável	1006382	49,00
Caixa de ligação		
● Preto	228725	19,90
Caixa de ligação IP68, 5 polos		
● Preto	1006453	35,00

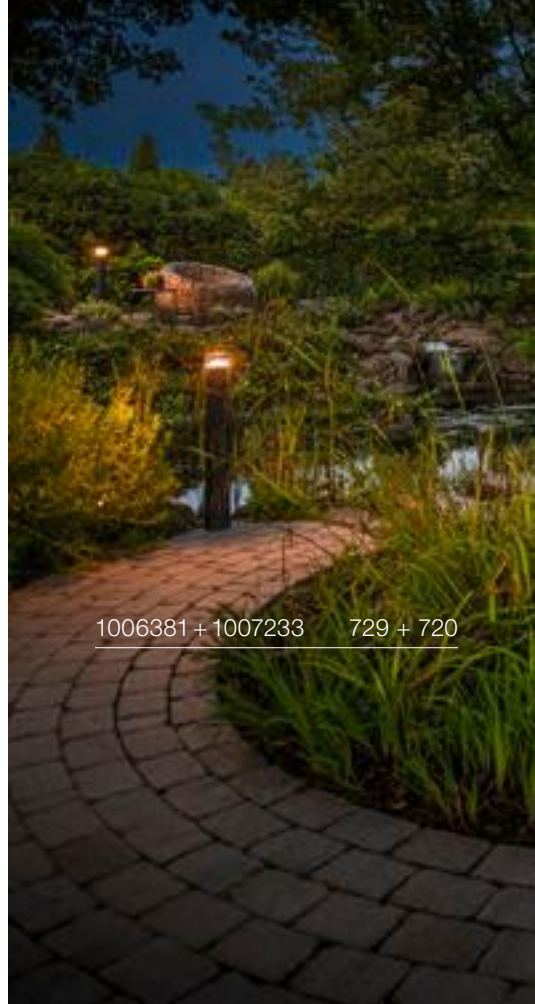

1006381 + 1007233 729 + 720



1006380 + 1007235 729 + 721





M-POL S  
Polehead 180°,  
Ofuscamento eliminado

M-POL S  
Polehead 180°,  
Ofuscamento eliminado, DALI

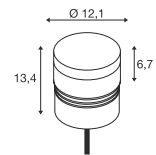
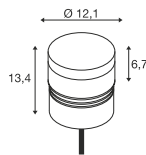

220-240V ~50/60Hz | 500mA  
Potência do sistema: 10W  
Material: alumínio

220-240V ~50/60Hz | 500mA  
Potência do sistema: 10W  
Material: alumínio

- Extremidade do cabo aberta
- Encontra o corpo da luminária e outros acessórios adequados nas páginas 728-729

- Extremidade do cabo aberta
- Encontra o corpo da luminária e outros acessórios adequados nas páginas 728-729



Down 700lm | 2700K



Down 700lm | 2700K

Versão	Art. n.º	EUR
● Antracite	1007234	299,00

Versão	Art. n.º	EUR
● Antracite	1007235	319,00



Artigo	Art. n.º	EUR
Âncora de chão		
● Aço inoxidável	1006382	49,00
Caixa de conector em T		
● Preto	228726	33,00
Caixa de ligação IP68 3 polos		
● Preto	228730	18,00



Artigo	Art. n.º	EUR
Âncora de chão		
● Aço inoxidável	1006382	49,00
Caixa de ligação		
● Preto	228725	19,90
Caixa de ligação IP68, 5 polos		
● Preto	1006453	35,00



1006381 + 1006389 729 + 723



1006381 + 1006393 729 + 723

## M-POL S Polehead

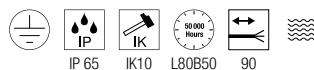
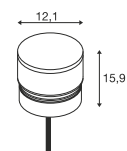

220-240V ~50/60Hz | 500mA  
Consumo de energia: 9W  
Potência do sistema: 11W  
Material: alumínio

- Extremidade do cabo aberta
- Encontra o corpo da luminária e outros acessórios adequados nas páginas 728-729



Down 470lm | 2700K | 510lm | 3000K

Versão	Art. n.º	EUR
● Antracite	1006383	259,00



Artigo	Art. n.º	EUR
Âncora de chão		
● Aço inoxidável	1006382	49,00
Caixa de conector em T		
● Preto	228726	33,00
Caixa de ligação IP68, 3 polos		
● Preto	228730	18,00



### M-POL S Polehead, DALI

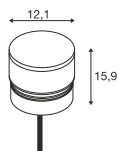

220-240V ~50/60Hz | 500mA  
Consumo de energia: 17W  
Potência do sistema: 19W  
Material: alumínio

- Extremidade do cabo aberta
- Encontra o corpo da luminária e outros acessórios adequados nas páginas 728-729



Down 890lm | 2700K | 950lm | 3000K

Versão	Art. n.º	EUR
● Antracite	1006389	365,00



Artigo	Art. n.º	EUR
Âncora de chão		
● Aço inoxidável	1006382	49,00
Caixa de ligação		
● Preto	228725	19,90
Caixa de ligação IP68, 5 polos		
● Preto	1006453	35,00

### M-POL S Polehead, Shader

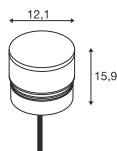

220-240V ~50/60Hz | 500mA  
Consumo de energia: 9W  
Potência do sistema: 11W  
Material: alumínio

- Extremidade do cabo aberta
- Encontra o corpo da luminária e outros acessórios adequados nas páginas 728-729



Down 285lm | 2700K | 310lm | 3000K

Versão	Art. n.º	EUR
● Antracite	1006387	279,00



Artigo	Art. n.º	EUR
Âncora de chão		
● Aço inoxidável	1006382	49,00
Caixa de conector em T		
● Preto	228726	33,00
Caixa de ligação IP68, 3 polos		
● Preto	228730	18,00

### M-POL S Polehead, Shader, DALI

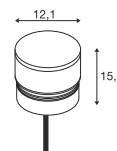

220-240V ~50/60Hz | 500mA  
Consumo de energia: 17W  
Potência do sistema: 19W  
Material: alumínio

- Extremidade do cabo aberta
- Encontra o corpo da luminária e outros acessórios adequados nas páginas 728-729



Down 520lm | 2700K | 550lm | 3000K

Versão	Art. n.º	EUR
● Antracite	1006393	385,00



Artigo	Art. n.º	EUR
Âncora de chão		
● Aço inoxidável	1006382	49,00
Caixa de ligação		
● Preto	228725	19,90
Caixa de ligação IP68, 5 polos		
● Preto	1006453	35,00

M-POL S  
Polehead, Louver

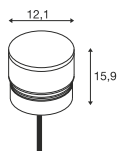

220-240V ~50/60Hz | 500mA  
Consumo de energia: 9W  
Potência do sistema: 11W  
Material: alumínio

- Extremidade do cabo aberta
- Encontra o corpo da luminária e outros acessórios adequados nas páginas 728-729



Down 145lm | 2700K | 155lm | 3000K

Versão	Art. n.º	EUR
● Antracite	1006385	315,00



Artigo	Art. n.º	EUR
Âncora de chão		
● Aço inoxidável	1006382	49,00
Caixa de conector em T		
● Preto	228726	33,00
Caixa de ligação IP68, 3 polos		
● Preto	228730	18,00

M-POL S  
Polehead, Louver, DALI

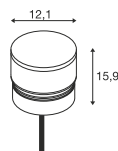

220-240V ~50/60Hz | 500mA  
Consumo de energia: 17W  
Potência do sistema: 19W  
Material: alumínio

- Extremidade do cabo aberta
- Encontra o corpo da luminária e outros acessórios adequados nas páginas 728-729



Down 260lm | 2700K | 270lm | 3000K

Versão	Art. n.º	EUR
● Antracite	1006391	449,00



Artigo	Art. n.º	EUR
Âncora de chão		
● Aço inoxidável	1006382	49,00
Caixa de ligação		
● Preto	228725	19,90
Caixa de ligação IP68, 5 polos		
● Preto	1006453	35,00



1006381 + 1006391 729 + 724

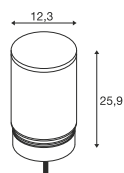

M-POL M  
Polehead

220-240V ~50/60Hz | 500mA  
Consumo de energia: 9W  
Potência do sistema: 11W  
Material: alumínio

- Extremidade do cabo aberta
- Encontra o corpo da luminária e outros acessórios adequados nas páginas 728-729



Down 590lm | 2700K | 660lm | 3000K

Versão	Art. n.º	EUR
● Antracite	1006384	279,00

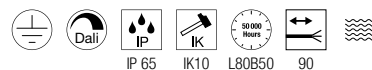
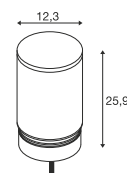

Artigo	Art. n.º	EUR
Âncora de chão		
● Aço inoxidável	1006382	49,00
Caixa de conector em T		
● Preto	228726	33,00
Caixa de ligação IP68, 3 polos		
● Preto	228730	18,00

M-POL M  
Polehead, DALI

220-240V ~50/60Hz | 500mA  
Consumo de energia: 17W  
Potência do sistema: 19W  
Material: alumínio

- Extremidade do cabo aberta
- Encontra o corpo da luminária e outros acessórios adequados nas páginas 728-729



Down 1150lm | 2700K | 1230lm | 3000K

Versão	Art. n.º	EUR
● Antracite	1006390	385,00



Artigo	Art. n.º	EUR
Âncora de chão		
● Aço inoxidável	1006382	49,00
Caixa de ligação		
● Preto	228725	19,90
Caixa de ligação IP68, 5 polos		
● Preto	1006453	35,00

1006379 + 1006384 729 + 725



## M-POL M Polehead, Shader

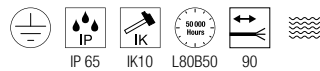
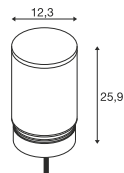

220-240V ~50/60Hz | 500mA  
Consumo de energia: 9W  
Potência do sistema: 11W  
Material: alumínio

- Extremidade do cabo aberta
- Encontra o corpo da luminária e outros acessórios adequados nas páginas 728-729



Down 420lm | 2700K | 460lm | 3000K

Versão	Art. n.º	EUR
● Antracite	1006388	299,00



Artigo	Art. n.º	EUR
Âncora de chão		
● Aço inoxidável	1006382	49,00
Caixa de conector em T		
● Preto	228726	33,00
Caixa de ligação IP68, 3 polos		
● Preto	228730	18,00

## M-POL M Polehead, Shader, DALI

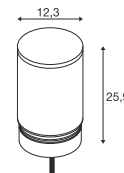

220-240V ~50/60Hz | 500mA  
Consumo de energia: 17W  
Potência do sistema: 19W  
Material: alumínio

- Extremidade do cabo aberta
- Encontra o corpo da luminária e outros acessórios adequados nas páginas 728-729



Down 820lm | 2700K | 870lm | 3000K

Versão	Art. n.º	EUR
● Antracite	1006394	409,00



Artigo	Art. n.º	EUR
Âncora de chão		
● Aço inoxidável	1006382	49,00
Caixa de ligação		
● Preto	228725	19,90
Caixa de ligação IP68, 5 polos		
● Preto	1006453	35,00



## M-POL M

### Polehead, Louver

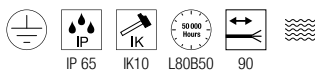
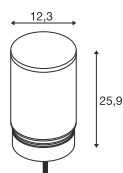

220-240V ~50/60Hz | 500mA  
Consumo de energia: 9W  
Potência do sistema: 11W  
Material: alumínio

- Extremidade do cabo aberta
- Encontra o corpo da luminária e outros acessórios adequados nas páginas 728-729



Down 190lm | 2700K | 210lm | 3000K

Versão	Art. n.º	EUR
● Antracite	1006386	439,00



Artigo	Art. n.º	EUR
Âncora de chão		
● Aço inoxidável	1006382	49,00
Caixa de conector em T		
● Preto	228726	33,00
Caixa de ligação IP68, 3 polos		
● Preto	228730	18,00

## M-POL M

### Polehead, Louver, DALI

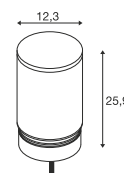

220-240V ~50/60Hz | 500mA  
Consumo de energia: 17W  
Potência do sistema: 19W  
Material: alumínio

- Extremidade do cabo aberta
- Encontra o corpo da luminária e outros acessórios adequados nas páginas 728-729



Down 350lm | 2700K | 370lm | 3000K

Versão	Art. n.º	EUR
● Antracite	1006392	529,00



Artigo	Art. n.º	EUR
Âncora de chão		
● Aço inoxidável	1006382	49,00
Caixa de ligação		
● Preto	228725	19,90
Caixa de ligação IP68, 5 polos		
● Preto	1006453	35,00

1006381 + 1006392 729 + 727



## M-POL CAP

NEW

Ø: 12,4



## M-POL Pole 60, Socket

NEW

Ø: 12,4



53,4

Material: alumínio

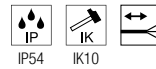

220-240V ~50/60Hz  
Material: alumínio

- Extremidade do cabo aberta

Versão	Art. n.º	EUR
● Antracite	1008475 ●	24,00

Versão	Art. n.º	EUR
● Antracite	1008474 ●	159,00

1006379 + 1006390 729 + 725





## M-POL 30 Pole

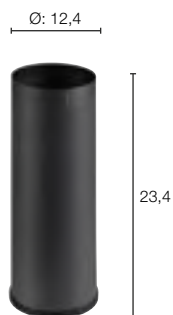

Material: alumínio

- Adequado a todas as cabeças de luminária das páginas 720-727

Versão	Art. n.º	EUR
● Antracite	1006379	99,00

## M-POL 60 Pole

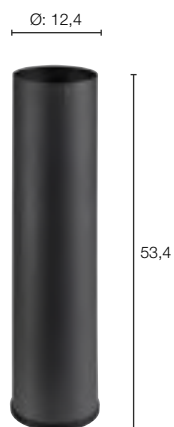

Material: alumínio

- Adequado a todas as cabeças de luminária das páginas 720-727

Versão	Art. n.º	EUR
● Antracite	1006380	139,00

## M-POL 90 Pole

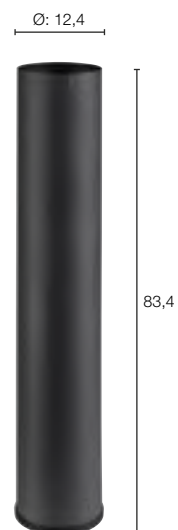

Material: alumínio

- Adequado a todas as cabeças de luminária das páginas 720-727

Versão	Art. n.º	EUR
● Antracite	1006381	169,00

# CRIE O SEU SISTEMA M-POL

---

Em poucos passos, crie o balizador de jardim ideal – graças à modelação do sistema M-POL. Para tal, combinam-se três corpos/tamanhos e oito cabeças da luminária com cinco propriedades da luz e duas temperaturas de cor. Quer seja em formato alto ou plano, com sombreamento(shader) para um efeito de luz esbatida num lado, uma radiação homogénea e difusa, sem encandeamento através de lâminas integradas. Em 2700K ou 3000K, na versão On/Off ou regulável em DALI. Configure os seus balizadores pretendidos M-POL e destaque com a melhor luz qualquer ambiente exterior.

## SELECIONE O(S) SEU(S)...

- 1 Altura do corpo da luminária (30, 60, 90)
- 2 Cabeça da luminária (On/Off, DALI)
- 3 Dimensão da cabeça da luminária (alta, plana)
- 4 Distribuição da luz (Clear, Shader, Louver)
- 5 Temperatura de cor (2700, 3000K)



JÁ ESTÁ!

# CABEÇAS DE LUMINÁRIA

## M-POL S

Ø: 12,3 cm, A: 15,9 cm

## M-POL M

Ø: 12,3 cm, A: 25,9 cm



**M-POL 30**  
Ø: 12,4 cm, A: 23,4 cm



**M-POL 60**  
Ø: 12,4 cm, A: 53,4 cm

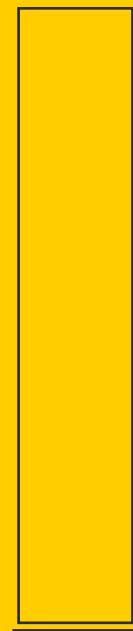

**M-POL 90**  
Ø: 12,4 cm, A: 83,4 cm

## POSTE



1006408 733



**CONCRETO**  
FL, Redondo, QPAR 51

**CONCRETO**  
FL, Quadrado, QPAR51

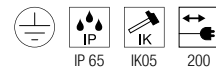
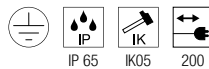
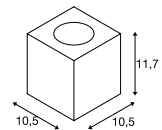
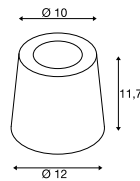

220-240V ~50/60Hz  
Material: betão/alumínio

220-240V ~50/60Hz  
Material: betão/alumínio

- Ficha de segurança IP44

- Ficha de segurança IP 44



Casquilho: 1xGU10 máx. Ø: 5,1 cm C: 6 cm

Casquilho: 1xGU10 máx. Ø: 5,1 cm C: 6 cm

Versão	Art. n.º	EUR
● Cinzento	1006408	120,00

Versão	Art. n.º	EUR
● Cinzento	1006409	120,00



LED GU10 51 mm | 6W | 38°  
2700K | 450lm | CEE=F  
6 kWh/1000h



Art. N.º: 1005077 | 7,50 EUR



LED GU10 51 mm | 6W | 38°  
2700K | 450lm | CEE=F  
6 kWh/1000h



Art. N.º: 1005077 | 7,50 EUR



1008385 735





# RASTERLYS

## Pole 70



A partir da primavera de 2025



220-240V ~50/60Hz | 350  
 Potência do sistema: 14W  
 Material: alumínio

- Extremidade do cabo aberta



Down 175lm | 2700K | 200lm | 3000K

Versão	Art. n.º	EUR
● Antracite	1008385	● 299,00



1004749 737



1004750 737





### ESKINA FRAME 45 Pole, single

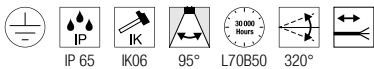
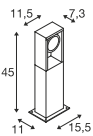

220-240V ~50/60Hz | 350mA  
Potência do sistema: 15W  
Material: alumínio

- Extremidade do cabo aberta



Down 1100lm | 3000K | 1200lm | 4000K

Versão	Art. n.º	EUR
● Antracite	1004749	282,00



Artigo	Art. n.º	EUR
Caixa de ligação IP68 3 polos		
● Preto	228730	18,00

### ESKINA FRAME 75 Pole, single

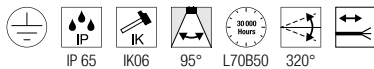
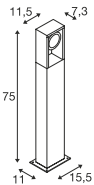

220-240V ~50/60Hz | 350mA  
Potência do sistema: 15W  
Material: alumínio

- Extremidade do cabo aberta



Down 1100lm | 3000K | 1200lm | 4000K

Versão	Art. n.º	EUR
● Antracite	1004750	308,00



Artigo	Art. n.º	EUR
Caixa de ligação IP68 3 polos		
● Preto	228730	18,00

### ESKINA FRAME 75 Pole, double

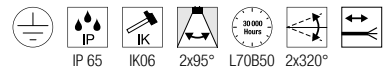
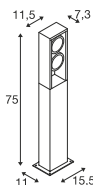

220-240V ~50/60Hz | 700mA  
Potência do sistema: 27W  
Material: alumínio

- Extremidade do cabo aberta



Spot 1 1100lm | 3000K | 1200lm | 4000K  
Spot 2 1100lm | 3000K | 1200lm | 4000K

Versão	Art. n.º	EUR
● Antracite	1004751	349,00



Artigo	Art. n.º	EUR
Caixa de ligação IP68 3 polos		
● Preto	228730	18,00

## ESKINA FRAME 125

Pole, double

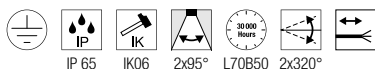
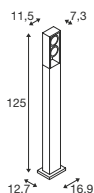

220-240V ~50/60Hz | 700mA  
Potência do sistema: 27W  
Material: alumínio

- Extremidade do cabo aberta



Spot 1	1100lm	3000K	1200lm	4000K
Spot 2	1100lm	3000K	1200lm	4000K

Versão	Art. n.º	EUR
● Antracite	1005439	403,00



Artigo	Art. n.º	EUR
Caixa de ligação IP68 3 polos		
● Preto	228730	18,00

## ESKINA FRAME 175

Pole, double

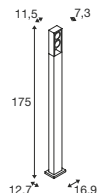

220-240V ~50/60Hz | 700mA  
Potência do sistema: 27W  
Material: alumínio

- Extremidade do cabo aberta



Spot 1	1100lm	3000K	1200lm	4000K
Spot 2	1100lm	3000K	1200lm	4000K

Versão	Art. n.º	EUR
● Antracite	1005440	474,00



Artigo	Art. n.º	EUR
Caixa de ligação IP68 3 polos		
● Preto	228730	18,00



1005439 738





**ESKINA 30**  
Pole

**ESKINA 80**  
Pole

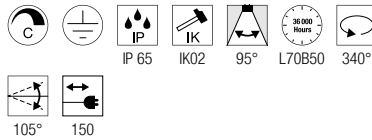
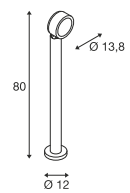
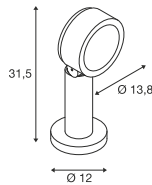

220-240V ~50/60Hz | 350mA  
Potência total: 14,5W  
Material: alumínio

- Ficha de segurança IP44

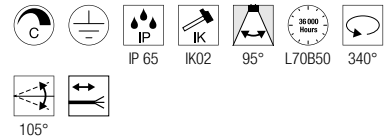

220-240V ~50/60Hz | 350mA  
Potência total: 14,5W  
Material: alumínio

- Extremidade do cabo aberta



Down 1100lm | 3000K | 1200lm | 4000K

Versão	Art. n.º	EUR
● Antracite	1002906	282,00



Artigo	Art. n.º	EUR
Estaca		
● Cinzento	230060	53,00



Down 1100lm | 3000K | 1200lm | 4000K

Versão	Art. n.º	EUR
● Antracite	1002907	308,00



Artigo	Art. n.º	EUR
Estaca		
● Cinzento	230060	53,00



1002907 739

T-TUBE 70  
Pole, GU10 single, Sensor

A partir da primavera de 2025



220-240V ~50/60Hz  
Material: alumínio

- Funcionalidade primária e de réplica, podem ser ligadas várias luminárias
- Extremidade do cabo aberta

**SOCKET INSIDE** 10 W

Casquilho: 1xGU10 máx. Ø: 5,1 cm | C: 5,5 cm

Versão	Art. n.º	EUR
● Preto	1008014	● 159,00

LED GU10 51 mm | 6W | 38°  
2700K | 450lm | CEE=F  
6 kWh/1000h



Art. N.º: 1005077 | 7,50 EUR

T-TUBE 70  
Pole, GU10 double, Sensor

A partir da primavera de 2025



220-240V ~50/60Hz  
Material: alumínio

- Funcionalidade primária e de réplica, podem ser ligadas várias luminárias
- Extremidade do cabo aberta

**SOCKET INSIDE** 10 W

Casquilho: 2xGU10 máx. Ø: 5,1 cm | C: 5,5 cm

Versão	Art. n.º	EUR
● Preto	1008015	● 199,00

LED QPAR51 | 2,4W | 36°  
2700K | 230lm | CEE=E  
3 kWh/1000h



Art. N.º: 1007230 | 5,50 EUR



1008015 740





### T-TUBE 70 Pole, GU10 single

A partir da primavera de 2025



### T-TUBE 70 Pole, GU10 double

A partir da primavera de 2025



220-240V ~50/60Hz  
Material: alumínio

- Extremidade do cabo aberta



220-240V ~50/60Hz  
Material: alumínio

- Extremidade do cabo aberta

**SOCKET INSIDE** 10 W

Casquilho: 1xGU10 máx. Ø: 5,1 cm | C: 5,5 cm

**SOCKET INSIDE** 10 W

Casquilho: 2xGU10 máx. Ø: 5,1 cm | C: 5,5 cm

Versão	Art. n.º	EUR
● Preto	1008016	● 139,00

Versão	Art. n.º	EUR
● Preto	1008017	● 179,00

1008017 741



LED QPAR51 | 6W | 38°  
3000K | 450lm | CEE=F  
6 kWh/1000h



Art. N.º: 1005080 | 7,50 EUR



LED QPAR51 | 2,4W | 36°  
3000K | 230lm | CEE=E  
3 kWh/1000h



Art. N.º: 1007231 | 5,50 EUR



232115

743



232125

743



## LOGS 40 Pole

## LOGS 70 Pole

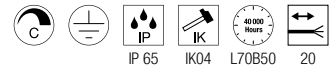
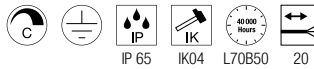
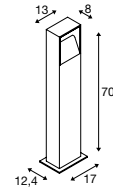
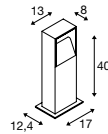

220-240V ~50/60Hz | 500mA  
Potência do sistema: 9,5W  
Material: alumínio

220-240V ~50/60Hz | 500mA  
Potência do sistema: 9,5W  
Material: alumínio

- Extremidade do cabo aberta

- Extremidade do cabo aberta



Down 570lm | 3000K

Down 570lm | 3000K

Versão	Art. n.º	EUR
● Antracite	232115	259,00

Versão	Art. n.º	EUR
● Antracite	232125	299,00

Artigo	Art. n.º	EUR
Âncora de betão		
● Cinzento	232119	61,00
Estaca		
● Cinzento	231230	45,50
Jogo de parafusos		
● Aço inoxidável	228754	4,50
Caixa de ligação IP68, 3 polos		
● Preto	228730	18,00

Artigo	Art. n.º	EUR
Âncora de betão		
● Cinzento	232119	61,00
Estaca		
● Cinzento	231230	45,50
Jogo de parafusos		
● Aço inoxidável	228754	4,50
Caixa de ligação IP68, 3 polos		
● Preto	228730	18,00







**GRAFIT 30**  
Pole, Redondo, E27

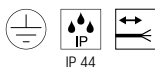
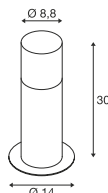

220-240V ~50/60Hz  
Material: alumínio/acrílico

- Extremidade do cabo aberta



Casquilho: 1xE27 máx. Ø: 6 cm | C: 11,5 cm

Versão	Art. n.º	EUR
● Antracite	1006180	80,00



A60 | 7,5W | 320°  
2700K | 800lm | CEE=F  
8 kWh/1000h



Art. N.º: 1005303 | 9,60 EUR



Artigo	Art. n.º	EUR
Caixa de ligação IP68, 3 polos		
● Preto	228730	18,00

**GRAFIT 60**  
Pole, Redondo, E27

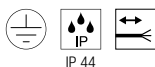
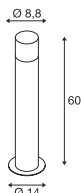

220-240V ~50/60Hz  
Material: alumínio/acrílico

- Extremidade do cabo aberta



Casquilho: 1xE27 máx. Ø: 6 cm | C: 11,5 cm

Versão	Art. n.º	EUR
● Antracite	1006181	100,00



LED E27 | 8W | 240°  
3000K | 880lm | CEE=E  
8 kWh/1000h



Art. N.º: 1005289 | 10,25 EUR



Artigo	Art. n.º	EUR
Caixa de ligação IP68, 3 polos		
● Preto	228730	18,00

**GRAFIT 90**  
Pole, Redondo, E27

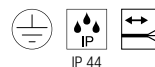

220-240V ~50/60Hz  
Material: alumínio/acrílico

- Extremidade do cabo aberta



Casquilho: 1xE27 máx. Ø: 6 cm | C: 11,5 cm

Versão	Art. n.º	EUR
● Antracite	1006182	131,00



LED E27 | 8W | 240°  
3000K | 880lm | CEE=E  
8 kWh/1000h



Art. N.º: 1005289 | 10,25 EUR



Artigo	Art. n.º	EUR
Caixa de ligação IP68, 3 polos		
● Preto	228730	18,00



231225 747



1006184 747



### GRAFIT 30 Pole, E27

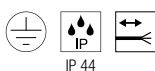
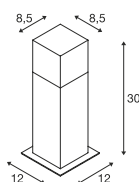

220-240V ~50/60Hz  
Material: alumínio/plástico

- Extremidade do cabo aberta



Casquilho: 1xE27 máx. Ø: 6 cm C: 11,5 cm

Versão	Art. n.º	EUR
● Antracite	231215	80,00



A60 | 7,5W | 320°  
2700K | 800lm | CEE=F  
8 kWh/1000h



Art. N.º: 1005303 | 9,60 EUR



Artigo	Art. n.º	EUR
Estaca		
● Cinzento	231230	45,50
Jogo de parafusos		
● Aço inoxidável	228754	4,50
Caixa de ligação IP68 3 polos		
● Preto	228730	18,00

### GRAFIT 60 Pole, E27

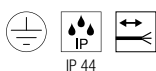
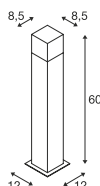

220-240V ~50/60Hz  
Material: alumínio/plástico

- Extremidade do cabo aberta



Casquilho: 1xE27 máx. Ø: 6 cm C: 11,5 cm

Versão	Art. n.º	EUR
● Antracite	231225	100,00



LED E27 | 8W | 240°  
3000K | 880lm | CEE=E  
8 kWh/1000h



Art. N.º: 1005289 | 10,25 EUR



Artigo	Art. n.º	EUR
Estaca		
● Cinzento	231230	45,50
Jogo de parafusos		
● Aço inoxidável	228754	4,50
Caixa de ligação IP68 3 polos		
● Preto	228730	18,00

### GRAFIT 90 Pole, E27

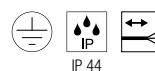
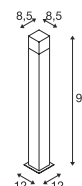

220-240V ~50/60Hz  
Material: alumínio/acrílico

- Extremidade do cabo aberta



Casquilho: 1xE27 máx. Ø: 6 cm C: 11,5 cm

Versão	Art. n.º	EUR
● Antracite	1006184	131,00



LED E27 | 8W | 240°  
3000K | 880lm | CEE=E  
8 kWh/1000h



Art. N.º: 1005289 | 10,25 EUR



Artigo	Art. n.º	EUR
Estaca		
● Cinzento	231230	45,50
Jogo de parafusos		
● Aço inoxidável	228754	4,50
Caixa de ligação IP68 3 polos		
● Preto	228730	18,00



1005442 749



## QUADRULO FL

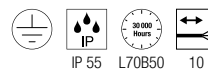
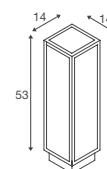

IP 55 L70B50 10

100-277V ~50/60Hz | 480mA

Potência do sistema: 7W

Material: alumínio/acrílico

- Caixa de ligação IP68 de 3 polos
- Extremidade do cabo aberta



Down

340lm | 3000K

Versão	Art. n.º	EUR
● Antracite	1005442	164,00

## RUSTY® SLOT 50 Pole

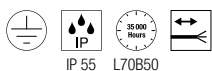
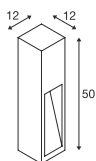

IP 55 L70B50

220-240V ~50/60Hz  
Potência do sistema: 9W  
Material: aço FeCSi/polycarbonato (PC)

- Extremidade do cabo aberta



Down 30lm | 3000K

Versão	Art. n.º	EUR
● Oxidado	233447	309,00



Artigo	Art. n.º	EUR
Estaca		
● Cinzento	231230	45,50
Caixa de ligação IP68		
3 polos		
● Preto	228730	18,00

## RUSTY® SLOT 80 Pole

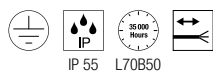
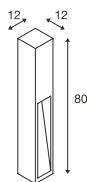

IP 55 L70B50

220-240V ~50/60Hz  
Potência do sistema: 9W  
Material: aço FeCSi/polycarbonato (PC)

- Extremidade do cabo aberta



Down 30lm | 3000K

Versão	Art. n.º	EUR
● Oxidado	233457	389,00



Artigo	Art. n.º	EUR
Estaca		
● Cinzento	231230	45,50
Caixa de ligação IP68		
3 polos		
● Preto	228730	18,00

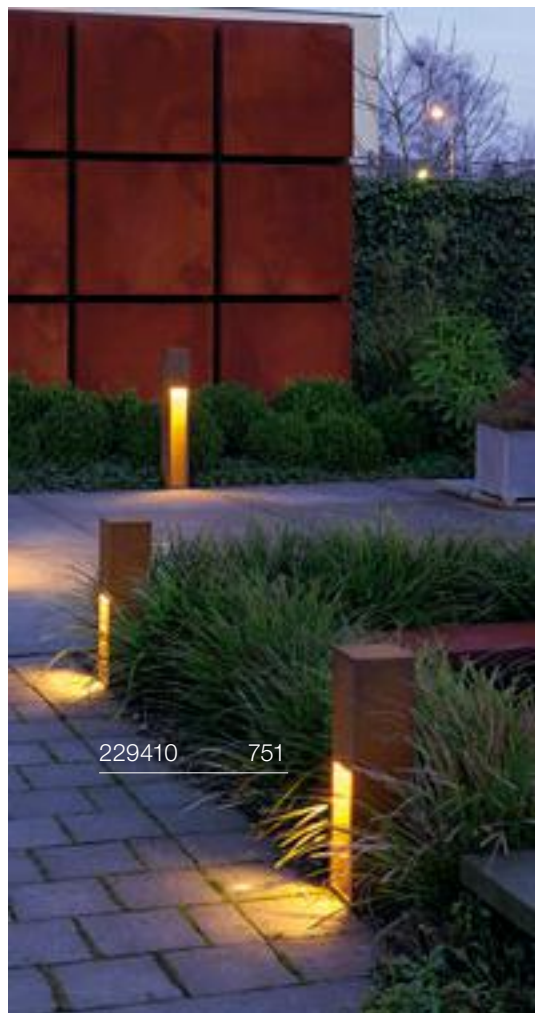

229410

751



233457 750

**RUSTY® SLOT 50**  
Pole, E27

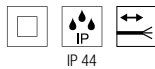
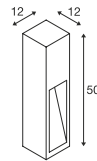

220-240V ~50/60Hz  
Material: aço FeCSi/polycarbonato (PC)

- Extremidade do cabo aberta



Casquilho: 1xE27 máx. Ø: 4,8 cm | C: 13,9 cm

Versão	Art. n.º	EUR
● Oxidado	229410	286,00



LED E27 | 8W | 240°  
4000K | 920lm | CEE=E  
8 kWh/1000h



Art. N.º: 1005290 | 10,25 EUR



Artigo	Art. n.º	EUR
Estaca		
● Cinzento	231230	45,50
Caixa de ligação IP68 3 polos		
● Preto	228730	18,00

**RUSTY® SLOT 80**  
Pole, E27

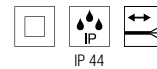
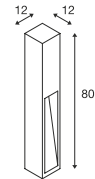

220-240V ~50/60Hz  
Material: aço FeCSi/polycarbonato (PC)

- Extremidade do cabo aberta



Casquilho: 1xE27 máx. Ø: 4,8 cm | C: 13,9 cm

Versão	Art. n.º	EUR
● Oxidado	229411	359,00



LED E27 | 8W | 240°  
4000K | 920lm | CEE=E  
8 kWh/1000h



Art. N.º: 1005290 | 10,25 EUR



Artigo	Art. n.º	EUR
Estaca		
● Cinzento	231230	45,50
Caixa de ligação IP68 3 polos		
● Preto	228730	18,00



229411 751

# RUSTY® PATHLIGHT

Pole, TCR-TSE

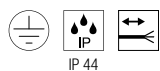
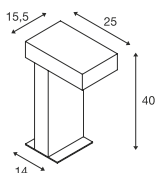

220-240V ~50/60Hz  
Material: aço FeCSi/policarbonato (PC)

- Extremidade do cabo aberta



Casquilho: 1xGX53 máx. Ø: 7,5 cm | C: 2,7 cm

Versão	Art. n.º	EUR
● Oxidado	230090	309,00



LED GX53 | 6,1W | 120°  
3000K | 490lm | CEE=G  
6 kWh/1000h



Art. N.º: 1005271 | 11,50 EUR



Artigo	Art. n.º	EUR
Estaca		
● Cinzento	229422	45,50
Caixa de ligação IP68 3 polos		
● Preto	228730	18,00



230090 752







**RUSTY® PATHLIGHT 40**  
Pole

**RUSTY® PATHLIGHT 70**  
Pole

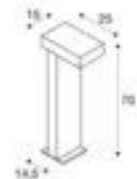
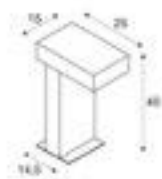

220-240V ~50/60Hz  
Potência do sistema: 8,8W  
Material: aço/acrílico

220-240V ~50/60Hz  
Potência do sistema: 8,8W  
Material: aço/acrílico

- Extremidade do cabo aberta

- Extremidade do cabo aberta



Down 470lm | 3000K

Down 470lm | 3000K

Versão	Art. n.º	EUR
● Oxidado	1006346	323,00

Versão	Art. n.º	EUR
● Oxidado	1006347	419,00

1006347 753

⊕

Artigo	Art. n.º	EUR
Estaca		
● Cinzento	229422	45,50
Caixa de ligação IP68 3 polos		
● Preto	228730	18,00

⊕

Artigo	Art. n.º	EUR
Estaca		
● Cinzento	229422	45,50
Caixa de ligação IP68 3 polos		
● Preto	228730	18,00



233437 755

## RUSTY® 40 Pole

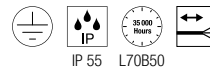
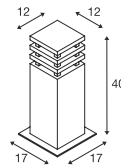

IP 55 L70B50

220-240V ~50/60Hz  
Potência do sistema: 9W  
Material: aço FeCSI/policarbonato (PC)

- Extremidade do cabo aberta



Down

90lm | 3000K

Versão	Art. n.º	EUR
● Oxidado	233427	309,00



229420 755



Artigo	Art. n.º	EUR
Estaca		
● Cinzento	229422	45,50
Caixa de ligação IP68 3 polos		
● Preto	228730	18,00



RUSTY® 70  
Pole

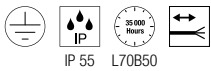
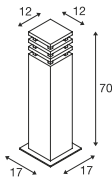
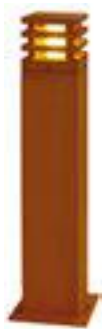

220-240V ~50/60Hz  
Potência do sistema: 9W  
Material: aço FeCSi/policarbonato (PC)

- Extremidade do cabo aberta



Down 90lm | 3000K

Versão	Art. n.º	EUR
● Oxidado	233437	389,00

RUSTY® 40  
Pole, E27

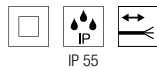
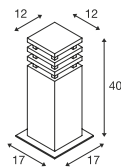

220-240V ~50/60Hz  
Material: aço FeCSi/policarbonato (PC)

- Extremidade do cabo aberta



Casquilho: 1xE27 máx. Ø: 4,8 cm | C: 13,9 cm

Versão	Art. n.º	EUR
● Oxidado	229420	284,00



LED E27 | 8W | 240°  
4000K | 920lm | CEE=E  
8 kWh/1000h



Art. N.º: 1005290 | 10,25 EUR



Artigo	Art. n.º	EUR
Estaca		
● Cinzento	229422	45,50
Caixa de ligação IP68 3 polos		
● Preto	228730	18,00

RUSTY® 70  
Pole, E27

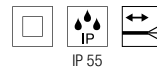
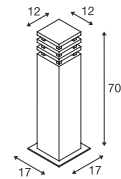

220-240V ~50/60Hz  
Material: aço FeCSi/policarbonato (PC)

- Extremidade do cabo aberta



Casquilho: 1xE27 máx. Ø: 4,8 cm | C: 13,9 cm

Versão	Art. n.º	EUR
● Oxidado	229421	359,00



LED E27 | 8W | 240°  
4000K | 920lm | CEE=E  
8 kWh/1000h



Art. N.º: 1005290 | 10,25 EUR



Artigo	Art. n.º	EUR
Estaca		
● Cinzento	229422	45,50
Caixa de ligação IP68 3 polos		
● Preto	228730	18,00





**RUSTY® CONE 24**  
FL, E14

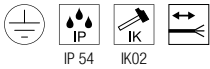
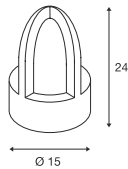

220-240V ~50/60Hz  
Material: aço FeCSi/vidro

- Extremidade do cabo aberta



Casquilho: 1xE14 máx. Ø: 4,8 cm | C: 13,9 cm

Versão	Art. n.º	EUR
● Oxidado	229430	274,00

C35 | 4,2W | 320°  
 2700K | 350lm | CEE=G  
 5 kWh/1000h

**Art. N.º: 1005285 | 8,50 EUR**

**RUSTY® CONE 40**  
Pole, E27

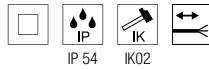
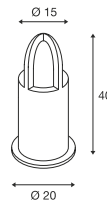

220-240V ~50/60Hz  
Material: aço FeCSi/vidro

- Extremidade do cabo aberta



Casquilho: 1xE27 máx. Ø: 4,8 cm | C: 13,9 cm

Versão	Art. n.º	EUR
● Oxidado	229431	419,00

LED E27 | 8W | 240°  
 4000K | 920lm | CEE=E  
 8 kWh/1000h

**Art. N.º: 1005290 | 10,25 EUR**

Artigo	Art. n.º	EUR
Estaca		
● Cinzento	229423	49,50
Caixa de ligação IP68 3 polos		
● Preto	228730	18,00

**RUSTY® CONE 70**  
Pole, E27

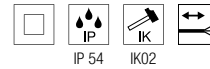
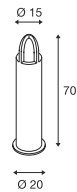

220-240V ~50/60Hz  
Material: aço FeCSi/polycarbonato (PC)

- Extremidade do cabo aberta



Casquilho: 1xE27 máx. Ø: 4,8 cm | C: 13,9 cm

Versão	Art. n.º	EUR
● Oxidado	229432	499,00

LED E27 | 8W | 240°  
 4000K | 920lm | CEE=E  
 8 kWh/1000h

**Art. N.º: 1005290 | 10,25 EUR**

Artigo	Art. n.º	EUR
Estaca		
● Cinzento	229423	49,50
Caixa de ligação IP68 3 polos		
● Preto	228730	18,00

RUSTY® 40  
Pole, E27

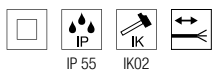
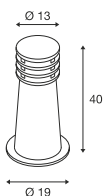

220-240V ~50/60Hz  
Material: aço FeCSi/policarbonato (PC)

- Extremidade do cabo aberta



Casquilho: 1xE27 máx. Ø: 4,8 cm C: 13,9 cm

Versão	Art. n.º	EUR
● Oxidado	229020	284,00



LED E27 | 8W | 240°  
4000K | 920lm | CEE=E  
8 kWh/1000h



Art. N.º: 1005290 | 10,25 EUR



Artigo	Art. n.º	EUR
Estaca		
● Aço inoxidável	229022	49,50
Caixa de ligação IP68 3 polos		
● Preto	228730	18,00

RUSTY® 70  
Pole, E27

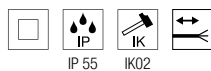
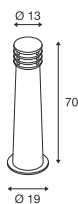

220-240V ~50/60Hz  
Material: aço FeCSi/policarbonato (PC)

- Extremidade do cabo aberta



Casquilho: 1xE27 máx. Ø: 4,8 cm C: 13,9 cm

Versão	Art. n.º	EUR
● Oxidado	229021	359,00



LED E27 | 8W | 240°  
4000K | 920lm | CEE=E  
8 kWh/1000h



Art. N.º: 1005290 | 10,25 EUR



Artigo	Art. n.º	EUR
Estaca		
● Aço inoxidável	229022	49,50
Caixa de ligação IP68 3 polos		
● Preto	228730	18,00



229020 758



231410 759



229021 758



231411 759

### ARROCK GRANITE 40

Pole, square, E27

### ARROCK GRANITE 70

Pole, square, E27

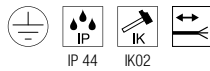
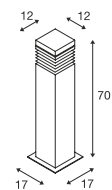
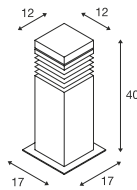

220-240V ~50/60Hz  
Material: granito/aço inoxidável 304

- Extremidade do cabo aberta

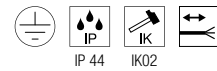

220-240V ~50/60Hz  
Material: granito/aço inoxidável 304

- Extremidade do cabo aberta



Casquilho: 1xE27 máx. Ø: 5,2 cm | C: 11,5 cm

Versão	Art. n.º	EUR
● Cinzento	231410	359,00



LED E27 | 8W | 240°  
3000K | 880lm | CEE=E  
8 kWh/1000h



Art. N.º: 1005289 | 10,25 EUR



Casquilho: 1xE27 máx. Ø: 5,2 cm | C: 11,5 cm

Versão	Art. n.º	EUR
● Cinzento	231411	434,00



LED E27 | 8W | 240°  
4000K | 920lm | CEE=E  
8 kWh/1000h



Art. N.º: 1005290 | 10,25 EUR



Artigo	Art. n.º	EUR
Estaca		
● Cinzento	229422	45,50
Caixa de ligação IP68 3 polos		
● Preto	228730	18,00



Artigo	Art. n.º	EUR
Estaca		
● Cinzento	229422	45,50
Caixa de ligação IP68 3 polos		
● Preto	228730	18,00

# ARROCK ARC

Pole, QPAR51

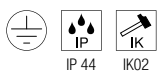
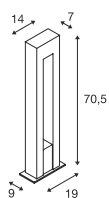

220-240V ~50/60Hz  
Material: granito/aço inoxidável 304



Casquilho: 1xGU10 máx. Ø: 5,1 cm | C: 7,6 cm

Versão	Art. n.º	EUR
● Cinzento	231420	359,00



LED GU10 51 mm | 6W | 36°  
2200-2700K | 360lm | CEE=G  
6 kWh/1000h



Art. N.º: 1005075 | 7,50 EUR



Artigo	Art. n.º	EUR
Estaca		
● Cinzento	231233	49,50



231420 760



231371 761



231440 761





### ARROCK STONE 50 Pole

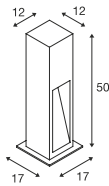

220-240V ~50/60Hz | 700mA  
Potência do sistema: 9W  
Material: basalto/ aço inoxidável 304

- Extremidade do cabo aberta



Down 330lm | 3000K

Versão	Art. n.º	EUR
● Cinzento	231370	413,00

### ARROCK STONE 75 Pole

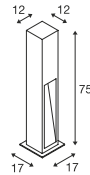

220-240V ~50/60Hz | 700mA  
Potência do sistema: 9W  
Material: basalto/ aço inoxidável 304

- Extremidade do cabo aberta



Down 330lm | 3000K

Versão	Art. n.º	EUR
● Cinzento	231371	474,00

### ARROCK SLOT Pole, QPAR51

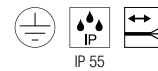
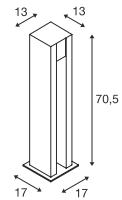

220-240V ~50/60Hz  
Material: granito/aço inoxidável 304

- Extremidade do cabo aberta



Casquilho: 1xGU10

Versão	Art. n.º	EUR
● Cinzento	231440	413,00



LED GU10 51 mm | 6W | 38°  
2700K | 450lm | CEE=F  
6 kWh/1000h



Art. N.º: 1005076 | 7,50 EUR



Artigo	Art. n.º	EUR
Estaca		
● Cinzento	231235	49,50



Artigo	Art. n.º	EUR
Estaca		
● Cinzento	231235	49,50



Artigo	Art. n.º	EUR
Estaca		
● Cinzento	231235	49,50
Caixa de ligação IP68		
3 polos		
● Preto	228730	18,00



1003535 763

## L-LINE OUT 30 FL, Vertical

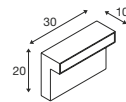

1003538 763



220-240V ~50/60Hz | 500mA  
Potência do sistema: 11,5W  
Material: alumínio/policarbonato (PC)

- A temperatura de cor deve ser definida antes da instalação
- Extremidade do cabo aberta



Down 800lm | 3000K | 810lm | 4000K

Versão	Art. n.º	EUR
● Antracite	1003536	232,00



Artigo	Art. n.º	EUR
Caixa de ligação IP68 3 polos		
● Preto	228730	18,00



### L-LINE OUT 60 FL, Vertical

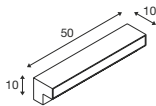

220-240V ~50/60Hz | 500mA  
Potência do sistema: 11,5W  
Material: alumínio/polycarbonato (PC)

- A temperatura de cor deve ser definida antes da instalação
- Extremidade do cabo aberta



Down 780lm | 3000K | 800lm | 4000K

Versão	Art. n.º	EUR
● Antracite	1003535	242,00



Artigo	Art. n.º	EUR
Caixa de ligação IP68 3 polos		
● Preto	228730	18,00

### L-LINE OUT 50 Pole, Horizontal

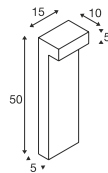

220-240V ~50/60Hz | 350mA  
Potência do sistema: 7W  
Material: alumínio/polycarbonato (PC)

- A temperatura de cor deve ser definida antes da instalação
- Extremidade do cabo aberta



Down 490lm | 3000K | 530lm | 4000K

Versão	Art. n.º	EUR
● Antracite	1003537	191,00



Artigo	Art. n.º	EUR
Caixa de ligação IP68 3 polos		
● Preto	228730	18,00

### L-LINE OUT 80 Pole, Horizontal

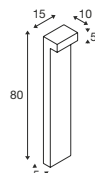

220-240V ~50/60Hz | 350mA  
Potência do sistema: 7W  
Material: alumínio/polycarbonato (PC)

- A temperatura de cor deve ser definida antes da instalação
- Extremidade do cabo aberta



Down 490lm | 3000K | 530lm | 4000K

Versão	Art. n.º	EUR
● Antracite	1003538	222,00



Artigo	Art. n.º	EUR
Caixa de ligação IP68 3 polos		
● Preto	228730	18,00

# THEO PATHLIGHT

Pole, double

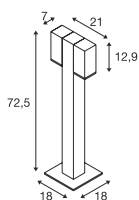

220-240V ~50/60Hz  
Material: alumínio

- Extremidade do cabo aberta



Casquilho: 2xGU10

Versão	Art. n.º	EUR
● Antracite	1002871	239,00



LED GU10 51 mm | 6W | 38°  
2700K | 450lm | CEE=F  
6 kWh/1000h



Art. N.º: 1005077 | 7,50 EUR



Artigo	Art. n.º	EUR
Caixa de ligação IP68 3 polos		
● Preto	228730	18,00



1002871 764



### OVALISK 75 Pole

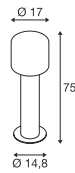

220-240V ~50/60Hz | 500mA  
Potência do sistema: 9,2W  
Material: alumínio/vidro

- Extremidade do cabo aberta



Down 580lm | 3000K | 630lm | 4000K

Versão	Art. n.º	EUR
● Antracite	1004680	329,00

### OVALISK 100 Pole

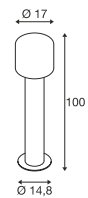

220-240V ~50/60Hz | 500mA  
Potência do sistema: 9,2W  
Material: alumínio/vidro

- Extremidade do cabo aberta



Down 580lm | 3000K | 630lm | 4000K

Versão	Art. n.º	EUR
● Antracite	1004681	359,00

⊕

Artigo	Art. n.º	EUR
Âncora de betão		
○ Prateado	228712	64,00
Estaca		
● Cinzento	228722	58,00
Caixa de ligação IP68 3 polos		
● Preto	228730	18,00

⊕

Artigo	Art. n.º	EUR
Âncora de betão		
○ Prateado	228712	64,00
Estaca		
● Cinzento	228722	58,00
Caixa de ligação IP68 3 polos		
● Preto	228730	18,00

1004680 765



1001999 767



1002001 767



**GLOO PURE 27**  
Pole, E27

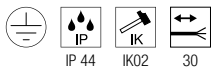
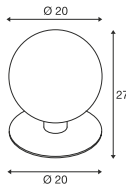

220-240V ~50/60Hz  
Material: alumínio/vidro

- Extremidade do cabo aberta



Casquilho: 1xE27 máx. Ø: 4,8 cm C: 18 cm

Versão	Art. n.º	EUR
● Antracite	1001999	93,00



LED E27 | 8W | 240°  
4000K | 920lm | CEE=E  
8 kWh/1000h



Art. N.º: 1005290 | 10,25 EUR



Artigo	Art. n.º	EUR
Estaca		
● Cinzento	231234	52,00
Caixa de ligação IP68 3 polos		
● Preto	228730	18,00

**GLOO PURE 44**  
Pole, E27

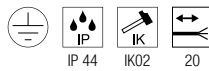
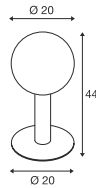

220-240V ~50/60Hz  
Material: alumínio/vidro

- Extremidade do cabo aberta



Casquilho: 1xE27 máx. Ø: 4,8 cm C: 18 cm

Versão	Art. n.º	EUR
● Antracite	1002000	124,00



LED E27 | 8W | 240°  
3000K | 880lm | CEE=E  
8 kWh/1000h



Art. N.º: 1005289 | 10,25 EUR



Artigo	Art. n.º	EUR
Estaca		
● Cinzento	231234	52,00
Caixa de ligação IP68 3 polos		
● Preto	228730	18,00

**GLOO PURE 70**  
Pole, E27

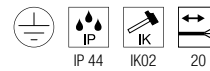
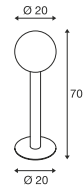

220-240V ~50/60Hz  
Material: alumínio/vidro

- Extremidade do cabo aberta



Casquilho: 1xE27 máx. Ø: 4,8 cm C: 18 cm

Versão	Art. n.º	EUR
● Antracite	1002001	136,00



LED E27 | 8W | 240°  
4000K | 920lm | CEE=E  
8 kWh/1000h



Art. N.º: 1005290 | 10,25 EUR



Artigo	Art. n.º	EUR
Estaca		
● Cinzento	231234	52,00
Caixa de ligação IP68 3 polos		
● Preto	228730	18,00



227221

769





ROTOBALL 25  
FL, E27

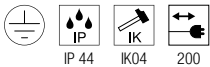
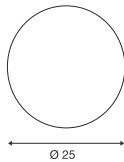

220-240V ~50/60Hz  
Material: aço/polietileno (PE)

- Ficha de segurança IP 44



Casquilho: 1xE27

Versão	Art. n.º	EUR
○ Branco	227219	159,00



A60 | 7,5W | 320°  
2700K | 800lm | CEE=F  
8 kWh/1000h



Art. N.º: 1005303 | 9,60 EUR

ROTOBALL 40  
FL, E27

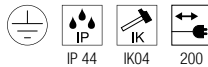
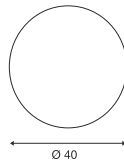

220-240V ~50/60Hz  
Material: aço/polietileno (PE)

- Ficha de segurança IP44



Casquilho: 1xE27

máx. Ø: 9,5 cm

Versão	Art. n.º	EUR
○ Branco	227220	179,00



A60 | 7,5W | 320°  
2700K | 800lm | CEE=F  
8 kWh/1000h



Art. N.º: 1005303 | 9,60 EUR

ROTOBALL 50  
FL, E27

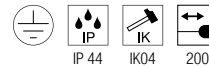
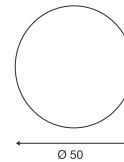

220-240V ~50/60Hz  
Material: aço/polietileno (PE)

- Ficha de segurança IP44



Casquilho: 1xE27

máx. Ø: 9,5 cm

Versão	Art. n.º	EUR
○ Branco	227221	239,00



A60 | 7,5W | 320°  
2700K | 800lm | CEE=F  
8 kWh/1000h



Art. N.º: 1005303 | 9,60 EUR



232075 771



230465 771



## PHOTONIA Pole, E27

## OTOS GLAS Pole, E27

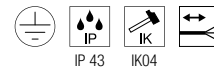
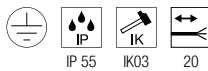
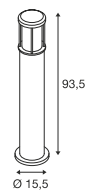

220-240V ~50/60Hz  
Material: alumínio/vidro

220-240V ~50/60Hz  
Material: alumínio/vidro

- Extremidade do cabo aberta

- Âncora de betão incluída.
- Extremidade do cabo aberta

**SOCKET INSIDE** <60 W

**SOCKET INSIDE** <15 W

Casquilho: 1xE27 máx. Ø: 9 cm | C: 15 cm

Casquilho: 1xE27 máx. Ø: 6,5 cm | C: 14,5 cm

Versão	Art. n.º	EUR
● Antracite	232075	274,00

Versão	Art. n.º	EUR
● Antracite	230465	144,00



A60 | 7,5W | 180°  
2700K | 720lm | CEE=F  
8 kWh/1000h



Art. N.º: 1005305 | 19,00 EUR



A60 | 7,5W | 320°  
2700K | 800lm | CEE=F  
8 kWh/1000h



Art. N.º: 1005303 | 9,60 EUR



Artigo	Art. n.º	EUR
Âncora de betão		
● Aço inoxidável	232085	49,50
Caixa de ligação IP68		
3 polos		
● Preto	228730	18,00



Artigo	Art. n.º	EUR
Jogo de parafusos		
● Aço inoxidável	228753	9,25
Caixa de ligação IP68		
3 polos		
● Preto	228730	18,00

CUBIX  
FL, QPAR51

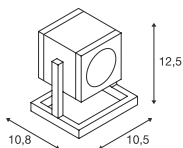

220-240V ~50/60Hz  
Material: alumínio/vidro

- Ficha de segurança IP44



Casquilho: 1xGU10

Versão	Art. n.º	EUR
● Antracite	132835	127,00



LED GU10 51 mm | 6W | 38°  
2700K | 450lm | CEE=F  
6 kWh/1000h



Art. N.º: 1005077 | 7,50 EUR

CONE  
FL, E27

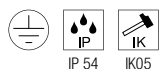
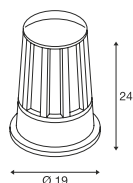

220-240V ~50/60Hz  
Material: alumínio/vidro



Casquilho: 1xE27

máx. C: 15 cm

Versão	Art. n.º	EUR
● Antracite	230435	100,00



A60 | 7,5W | 180°  
2700K | 720lm | CEE=F  
8 kWh/1000h



Art. N.º: 1005305 | 19,00 EUR





1000821 773

**MOLAT**  
PD, E27

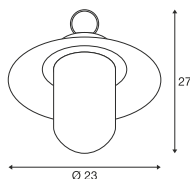

220-240V ~50/60Hz  
Material: alumínio/vidro

- Inclui corrente para suspensão
- Ficha de segurança IP44



Casquilho: 1xE27 máx. Ø: 6,5 cm | C: 14,5 cm

Versão	Art. n.º	EUR
● Antracite	1000821	139,00



A60 | 7,5W | 320°  
2700K | 800lm | CEE=F  
8 kWh/1000h



Art. N.º: 1005303 | 9,60 EUR



Artigo	Art. n.º	EUR
Roseta para teto		
● Antracite	1000398	80,00

**MOLAT**  
Pole, E27

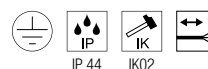
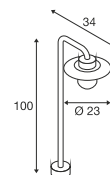

220-240V ~50/60Hz  
Material: alumínio/vidro

- Extremidade do cabo aberta



Casquilho: 1xE27 máx. Ø: 6,5 cm | C: 14,5 cm

Versão	Art. n.º	EUR
● Antracite	1000822	179,00



LED E27 | 7,5W | 320°  
2500K | 700lm | CEE=F  
8 kWh/1000h



Art. N.º: 1005265 | 26,50 EUR



Artigo	Art. n.º	EUR
Estaca		
● Cinzento	230060	53,00



1000822 773

LISENNE 40  
Pole, E27

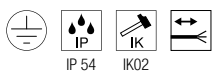
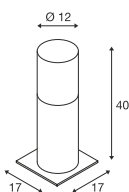

220-240V ~50/60Hz  
Material: basalto/vidro

- Extremidade do cabo aberta



Casquilho: 1xE27 máx. Ø: 5,9 cm C: 15 cm

Versão	Art. n.º	EUR
● Cinzento	1000665	400,00



LED E27 | 7,5W | 320°  
2700K | 800lm | CEE=F  
8 kWh/1000h



Art. N.º: 1005268 | 12,25 EUR



Artigo	Art. n.º	EUR
Estaca		
● Cinzento	229422	45,50
Caixa de ligação IP68		
3 polos		
● Preto	228730	18,00

LISENNE 70  
Pole, E27

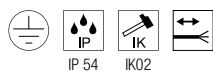
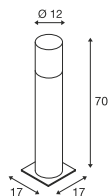

220-240V ~50/60Hz  
Material: basalto/vidro

- Extremidade do cabo aberta



Casquilho: 1xE27 máx. Ø: 5,9 cm C: 15 cm

Versão	Art. n.º	EUR
● Cinzento	1000666	458,00



LED E27 | 7,5W | 320°  
2700K | 800lm | CEE=F  
8 kWh/1000h



Art. N.º: 1005268 | 12,25 EUR



Artigo	Art. n.º	EUR
Estaca		
● Cinzento	229422	45,50
Caixa de ligação IP68		
3 polos		
● Preto	228730	18,00



1000665 774



228965 775



## ADEGAN FL, E27



1000666 774

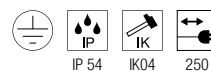
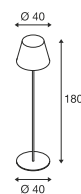

220-240V ~50/60Hz  
Material: alumínio/polycarbonato (PC)

- Ficha de segurança IP44

**SOCKET INSIDE** <24 W

Casquilho: 1xE27

máx. Ø: 5,2 cm

Versão	Art. n.º	EUR
● Antracite	228965	303,00



LED E27 | 8W | 240°  
3000K | 880lm | CEE=E  
8 kWh/1000h



Art. N.º: 1005289 | 10,25 EUR



Artigo	Art. n.º	EUR
Estaca		
● Antracite	228960	36,00



228935     777



228925     777





**ALPA MUSHROOM 45**  
Pole, E27

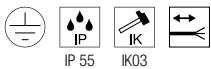
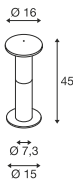

220-240V ~50/60Hz  
Material: alumínio/policarbonato (PC)

- Extremidade do cabo aberta



Casquilho: 1xE27 máx. Ø: 5,2 cm C: 16 cm

Versão	Art. n.º	EUR
● Antracite	228935	131,00



LED E27 | 8W | 240°  
3000K | 880lm | CEE=E  
8 kWh/1000h



Art. N.º: 1005289 | 10,25 EUR



Artigo	Art. n.º	EUR
Âncora de betão		
○ Prateado	228712	64,00
Estaca		
● Cinzento	228722	58,00
Caixa de ligação IP68 3 polos		
● Preto	228730	18,00

**ALPA MUSHROOM 75**  
Pole, E27

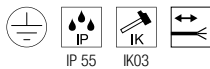
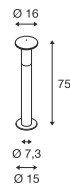

220-240V ~50/60Hz  
Material: alumínio/policarbonato (PC)

- Extremidade do cabo aberta



Casquilho: 1xE27 máx. Ø: 5,2 cm C: 16 cm

Versão	Art. n.º	EUR
● Antracite	228945	161,00



LED E27 | 8W | 240°  
3000K | 880lm | CEE=E  
8 kWh/1000h



Art. N.º: 1005289 | 10,25 EUR



Artigo	Art. n.º	EUR
Âncora de betão		
○ Prateado	228712	64,00
Estaca		
● Cinzento	228722	58,00
Caixa de ligação IP68 3 polos		
● Preto	228730	18,00

**ALPA CONE 100**  
Pole, E27

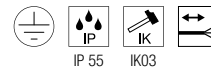
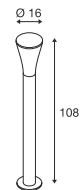

220-240V ~50/60Hz  
Material: alumínio/policarbonato (PC)

- Extremidade do cabo aberta



Casquilho: 1xE27 máx. Ø: 5,2 cm C: 17,5 cm

Versão	Art. n.º	EUR
● Antracite	228925	191,00



LED E27 | 8W | 240°  
3000K | 880lm | CEE=E  
8 kWh/1000h



Art. N.º: 1005289 | 10,25 EUR



Artigo	Art. n.º	EUR
Âncora de betão		
○ Prateado	228712	64,00
Estaca		
● Cinzento	228722	58,00
Caixa de ligação IP68 3 polos		
● Preto	228730	18,00

APONI 90  
Pole, PHASE

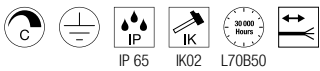
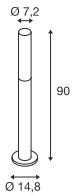

IP 65 IK02 L70B50

220-240V ~50/60Hz | 500mA  
Potência do sistema: 6,3W  
Material: alumínio

- Extremidade do cabo aberta



Down 520lm | 3000K

Versão	Art. n.º	EUR
● Antracite	1000682	259,00



Artigo	Art. n.º	EUR
Caixa de ligação IP68 3 polos		
● Preto	228730	18,00

APONI 120  
Pole, PHASE

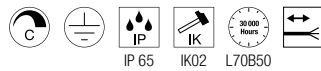
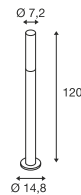

IP 65 IK02 L70B50

220-240V ~50/60Hz | 500mA  
Potência do sistema: 6,3W  
Material: alumínio

- Extremidade do cabo aberta



Down 520lm | 3000K

Versão	Art. n.º	EUR
● Antracite	1000683	320,00



Artigo	Art. n.º	EUR
Caixa de ligação IP68 3 polos		
● Preto	228730	18,00





1000682 778

### TRUST 30 Pole

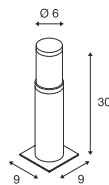

220-240V ~50/60Hz  
Potência do sistema: 9W  
Material: aço inoxidável 316

- Extremidade do cabo aberta



Down 400lm | 3000K

Versão	Art. n.º	EUR
● Aço inoxidável	<b>228100</b>	<b>259,00</b>

228110 779



### TRUST 60 Pole

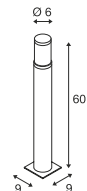

220-240V ~50/60Hz  
Potência do sistema: 9W  
Material: aço inoxidável 316

- Extremidade do cabo aberta



Down 400lm | 3000K

Versão	Art. n.º	EUR
● Aço inoxidável	<b>228110</b>	<b>332,00</b>

⊕

Artigo	Art. n.º	EUR
Estaca		
● Cinzento	<b>227922</b>	<b>53,00</b>
Grelha em forma de anel		
● Aço inoxidável	<b>228130</b>	<b>97,00</b>
Caixa de ligação IP68		
3 polos		
● Preto	<b>228730</b>	<b>18,00</b>

⊕

Artigo	Art. n.º	EUR
Estaca		
● Cinzento	<b>227922</b>	<b>53,00</b>
Grelha em forma de anel		
● Aço inoxidável	<b>228130</b>	<b>97,00</b>
Caixa de ligação IP68		
3 polos		
● Preto	<b>228730</b>	<b>18,00</b>

**BIG NAILS 50**  
POLE, E27

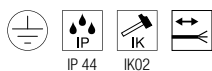
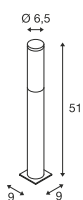

220-240V ~50/60Hz  
Material: aço inoxidável 304/policarbonato (PC)

- Extremidade do cabo aberta



Casquilho: 1xE27 máx. Ø: 4,5 cm C: 17 cm

Versão	Art. n.º	EUR
● Aço inoxidável	229162	162,00



LED E27 | 8W | 240°  
4000K | 920lm | CEE=E  
8 kWh/1000h



Art. N.º: 1005290 | 10,25 EUR



Artigo	Art. n.º	EUR
Estaca		
● Preto	227922	53,00

**BIG NAILS 80**  
POLE, E27

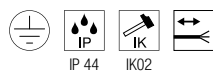
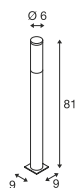

220-240V ~50/60Hz  
Material: aço inoxidável 304/policarbonato (PC)

- Extremidade do cabo aberta



Casquilho: 1xE27 máx. Ø: 4,5 cm C: 17 cm

Versão	Art. n.º	EUR
● Aço inoxidável	229172	186,00



LED E27 | 8W | 240°  
4000K | 920lm | CEE=E  
8 kWh/1000h



Art. N.º: 1005290 | 10,25 EUR



Artigo	Art. n.º	EUR
Estaca		
● Preto	227922	53,00



229162 780



229172 780



1001490 781



### ROX ACRYL 30

Pole, E27

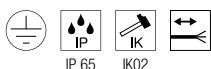
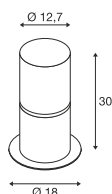

220-240V ~50/60Hz  
Material: aço inoxidável 304

- Extremidade do cabo aberta



Casquilho: 1xE27 máx. Ø: 6 cm C: 15 cm

Versão	Art. n.º	EUR
● Aço inoxidável	1001488	161,00



LED E27 | 8W | 240°  
3000K | 880lm | CEE=E  
8 kWh/1000h



Art. N.º: 1005289 | 10,25 EUR



Artigo	Art. n.º	EUR
Âncora de betão		
● Aço inoxidável	1001494	29,50
Estaca		
● Cinzento	231234	52,00
Caixa de conector em T		
● Preto	228726	33,00

### ROX ACRYL 60

Pole, E27

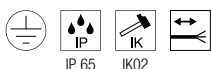
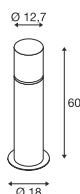

220-240V ~50/60Hz  
Material: aço inoxidável 304

- Extremidade do cabo aberta



Casquilho: 1xE27 máx. Ø: 6 cm C: 15 cm

Versão	Art. n.º	EUR
● Aço inoxidável	1001489	191,00



LED E27 | 8W | 240°  
3000K | 880lm | CEE=E  
8 kWh/1000h



Art. N.º: 1005289 | 10,25 EUR



Artigo	Art. n.º	EUR
Âncora de betão		
● Aço inoxidável	1001494	29,50
Estaca		
● Cinzento	231234	52,00
Caixa de conector em T		
● Preto	228726	33,00

### ROX ACRYL 90

Pole, E27

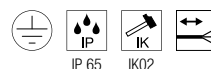
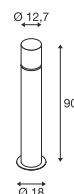

220-240V ~50/60Hz  
Material: aço inoxidável 304

- Extremidade do cabo aberta



Casquilho: 1xE27 máx. Ø: 6 cm C: 15 cm

Versão	Art. n.º	EUR
● Aço inoxidável	1001490	211,00



LED E27 | 8W | 240°  
3000K | 880lm | CEE=E  
8 kWh/1000h



Art. N.º: 1005289 | 10,25 EUR



Artigo	Art. n.º	EUR
Âncora de betão		
● Aço inoxidável	1001494	29,50
Estaca		
● Cinzento	231234	52,00
Caixa de conector em T		
● Preto	228726	33,00



230066 783

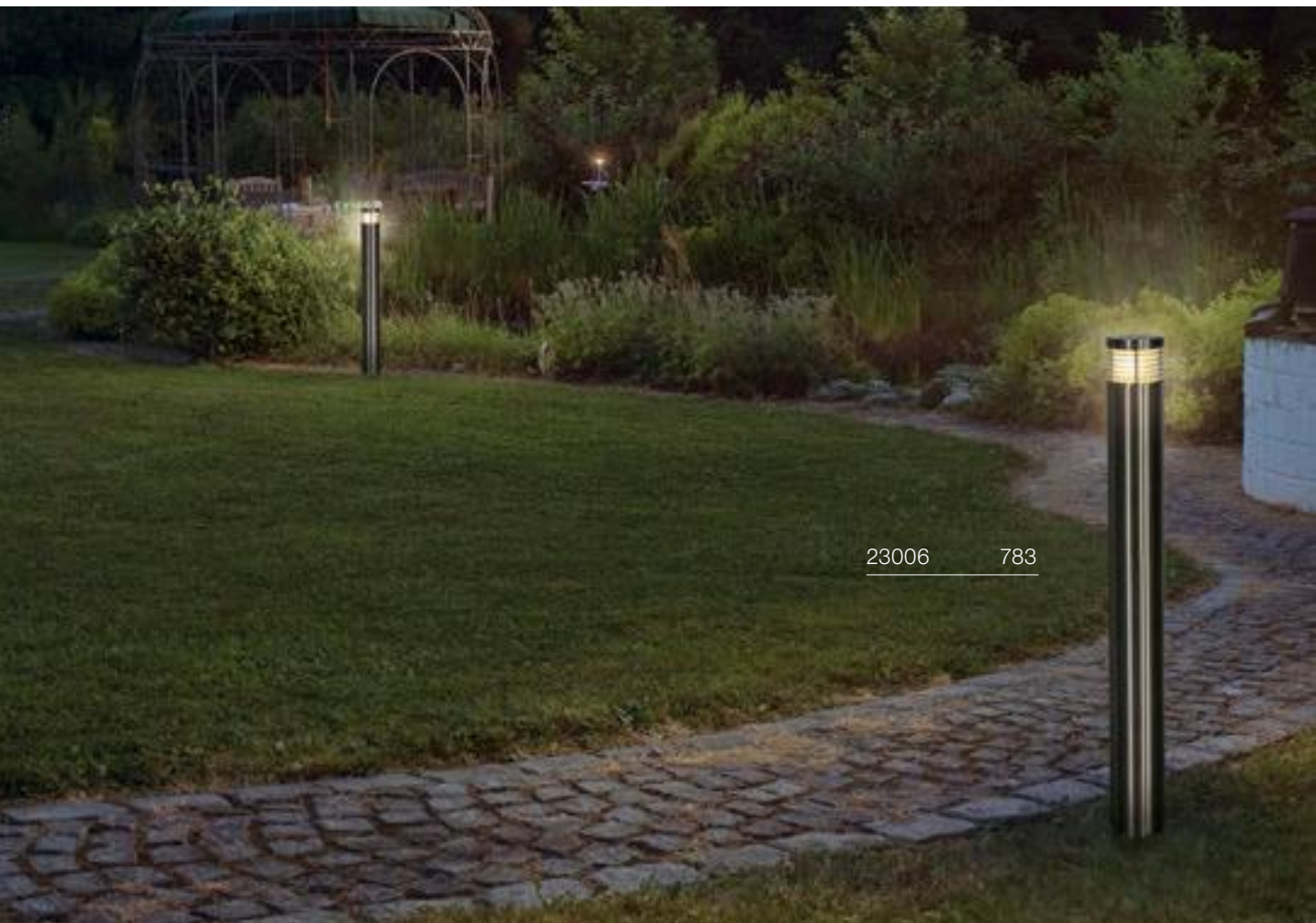

23006 783



VAP SLIM 30  
Pole, E27

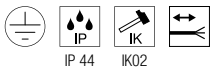
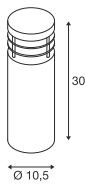

220-240V ~50/60Hz  
Material: aço inoxidável 304

- Extremidade do cabo aberta



Casquilho: 1xE27 máx. Ø: 5,1 cm C: 12,6 cm

Versão	Art. n.º	EUR
● Aço inoxidável	230063	169,00

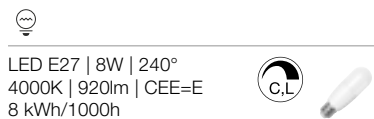

Art. N.º: 1005290 | 10,25 EUR

Artigo	Art. n.º	EUR
Âncora de betão		
● Aço inoxidável	230061	26,25
Estaca		
● Cinzento	230060	53,00

VAP SLIM 60  
Pole, E27

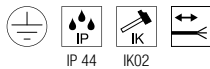
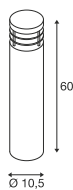

220-240V ~50/60Hz  
Material: aço inoxidável 304

- Extremidade do cabo aberta



Casquilho: 1xE27 máx. Ø: 5,1 cm C: 12,6 cm

Versão	Art. n.º	EUR
● Aço inoxidável	230066	189,00

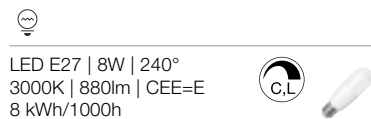

Art. N.º: 1005289 | 10,25 EUR

Artigo	Art. n.º	EUR
Âncora de betão		
● Aço inoxidável	230061	26,25
Estaca		
● Cinzento	230060	53,00

VAP SLIM 90  
Pole, E27

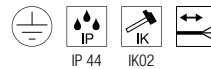

220-240V ~50/60Hz  
Material: aço inoxidável 304

- Extremidade do cabo aberta



Casquilho: 1xE27 máx. Ø: 5,1 cm C: 12,6 cm

Versão	Art. n.º	EUR
● Aço inoxidável	230069	219,00

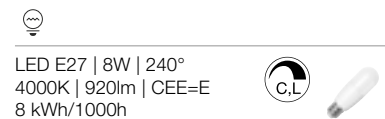

Art. N.º: 1005290 | 10,25 EUR

Artigo	Art. n.º	EUR
Âncora de betão		
● Aço inoxidável	230061	26,25
Estaca		
● Cinzento	230060	53,00

**C-POL**  
POLE, E27



**F-POL**  
POLE, E27

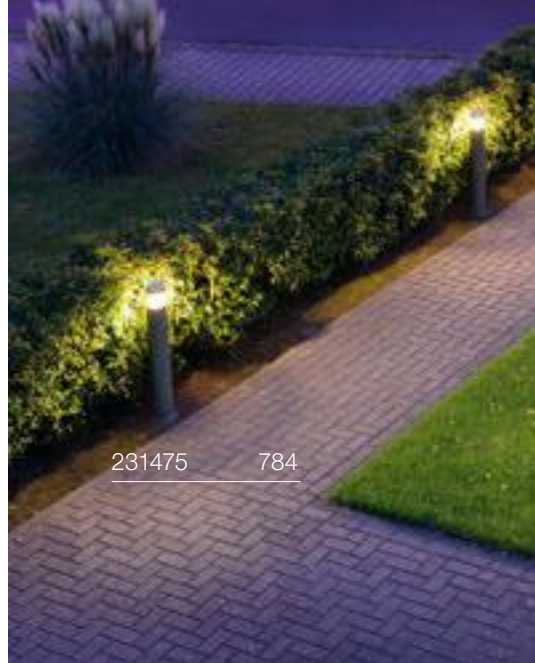

231475 784

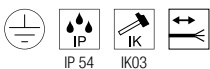
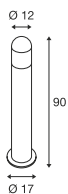

IP 54 IK03

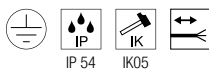

IP 54 IK05

220-240V ~50/60Hz  
Material: alumínio/policarbonato (PC)

- Extremidade do cabo aberta

220-240V ~50/60Hz  
Material: alumínio/policarbonato (PC)

- Extremidade do cabo aberta



Casquilho: 1xE27 máx. Ø: 5,2 cm C: 17,3 cm

Versão	Art. n.º	EUR
● Antracite	231475	201,00



Casquilho: 1xE27 máx. Ø: 5,1 cm C: 14,8 cm

Versão	Art. n.º	EUR
● Antracite	231595	191,00



231595 784



LED E27 | 8W | 240°  
3000K | 880lm | CEE=E  
8 kWh/1000h



Art. N.º: 1005289 | 10,25 EUR



LED E27 | 8W | 240°  
3000K | 880lm | CEE=E  
8 kWh/1000h



Art. N.º: 1005289 | 10,25 EUR



Artigo	Art. n.º	EUR
Caixa de ligação IP68 3 polos	228730	18,00
● Preto	228730	18,00



Artigo	Art. n.º	EUR
Caixa de ligação IP68 3 polos	228730	18,00
● Preto	228730	18,00

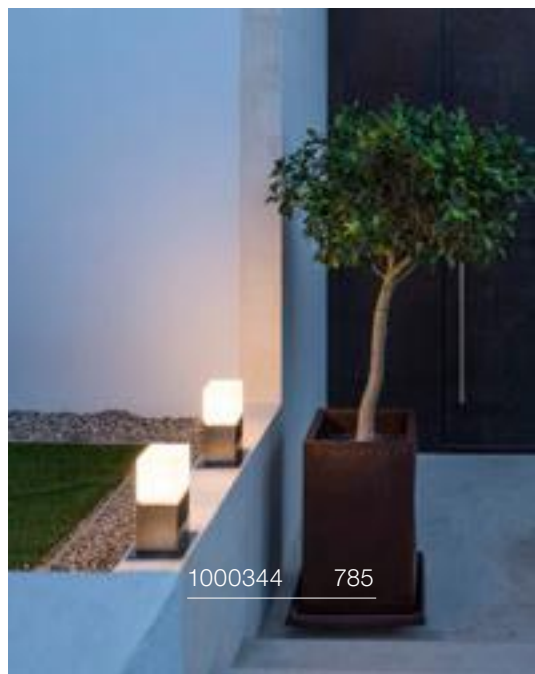

1000344 785





### SQUARE POLE 30

Pole, E27

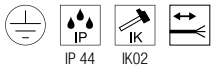
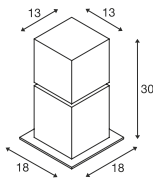

220-240V ~50/60Hz  
Material: aço inoxidável 304

- Extremidade do cabo aberta



Casquilho: 1xE27 máx. Ø: 6 cm C: 15 cm

Versão	Art. n.º	EUR
● Aço inoxidável	1000344	229,00



13,5W | 240°  
3000K | 1520lm | CEE=E  
14 kWh/1000h



Art. N.º: 1005307 | 12,50 EUR



Artigo	Art. n.º	EUR
Âncora de betão		
● Aço inoxidável	1000343	54,00
Estaca		
● Cinzento	231234	52,00
Caixa de ligação IP68		
3 polos		
● Preto	228730	18,00

### SQUARE POLE 60

Pole, E27

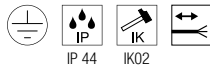
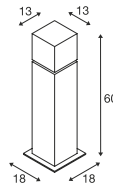

220-240V ~50/60Hz  
Material: aço inoxidável 304

- Extremidade do cabo aberta



Casquilho: 1xE27 máx. Ø: 6 cm C: 15 cm

Versão	Art. n.º	EUR
● Aço inoxidável	1000345	289,00



LED E27 | 8W | 240°  
3000K | 880lm | CEE=E  
8 kWh/1000h



Art. N.º: 1005289 | 10,25 EUR



Artigo	Art. n.º	EUR
Âncora de betão		
● Aço inoxidável	1000343	54,00
Estaca		
● Cinzento	231234	52,00
Caixa de ligação IP68		
3 polos		
● Preto	228730	18,00

### SQUARE POLE 90

Pole, E27

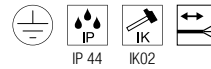
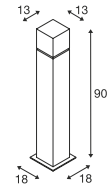

220-240V ~50/60Hz  
Material: aço inoxidável 304

- Extremidade do cabo aberta



Casquilho: 1xE27 máx. Ø: 6 cm C: 15 cm

Versão	Art. n.º	EUR
● Aço inoxidável	1000346	339,00



13,5W | 240°  
3000K | 1520lm | CEE=E  
14 kWh/1000h



Art. N.º: 1005307 | 12,50 EUR



Artigo	Art. n.º	EUR
Âncora de betão		
● Aço inoxidável	1000343	54,00
Estaca		
● Cinzento	231234	52,00
Caixa de ligação IP68		
3 polos		
● Preto	228730	18,00



231455

787



## SLOTS 45 Pole

## SLOTS 65 Pole

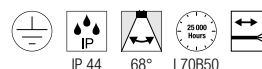
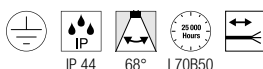
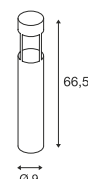
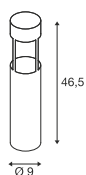

220-240V ~50/60Hz  
Potência do sistema: 4,5W  
Material: alumínio

220-240V ~50/60Hz  
Potência do sistema: 4,5W  
Material: alumínio

- Extremidade do cabo aberta
- Âncora de betão incluída.

- Extremidade do cabo aberta
- Âncora de betão incluída.



Down 200lm | 3000K

Down 200lm | 3000K

Versão	Art. n.º	EUR
● Antracite	231815	179,00
● Oxidado	231817	179,00

Versão	Art. n.º	EUR
● Antracite	231455	189,00
● Oxidado	231457	189,00



Artigo	Art. n.º	EUR
Caixa de ligação IP68 3 polos		
● Preto	228730	18,00
Jogo de parafusos		
● Aço inoxidável	228753	9,25

Artigo	Art. n.º	EUR
Caixa de ligação IP68 3 polos		
● Preto	228730	18,00
Jogo de parafusos		
● Aço inoxidável	228753	9,25

H-POL 30  
Pole

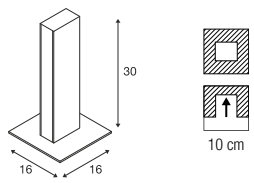

100-277V ~50/60Hz | 480mA  
Potência do sistema: 9,7W  
Material: alumínio/plástico

- Este produto serve para encastrar em pavimento oco
- Está disponível uma caixa de instalação maior para instalação opcional no solo  
Dimensões de montagem  
C: 14 cm L: 14 cm P: 16 cm



Down 430lm | 3000K

Versão	Art. n.º	EUR
● Antracite	232155	242,00



Artigo	Art. n.º	EUR
Caixa de instalação 14x14cm		
● Preto	232195	49,50

H-POL 60  
Pole

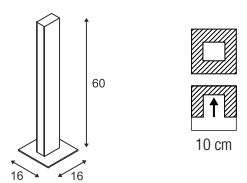

100-277V ~50/60Hz | 500mA  
Potência do sistema: 18W  
Material: alumínio/plástico

- Este produto serve para encastrar em pavimento oco
- Está disponível uma caixa de instalação maior para instalação opcional no solo  
Dimensões de montagem  
C: 14 cm L: 14 cm P: 16 cm



Down 700lm | 3000K

Versão	Art. n.º	EUR
● Antracite	232165	353,00



Artigo	Art. n.º	EUR
Caixa de instalação 14x14cm		
● Preto	232195	49,50



232155 788



## H-POL TWIN 60 Pole

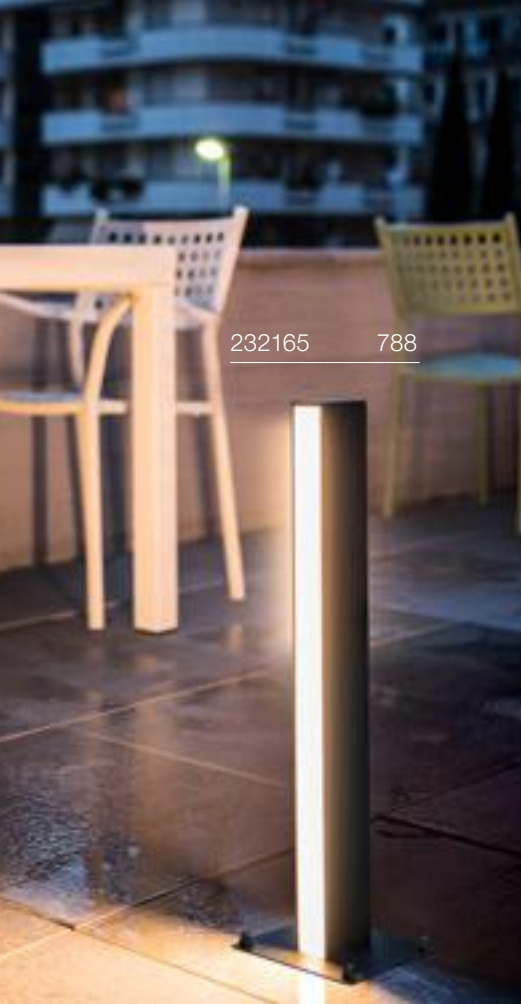

232165 788

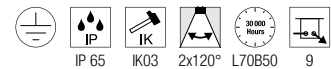
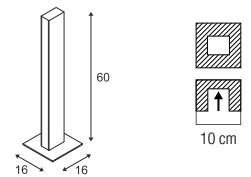

220-240V ~50/60Hz | 1000mA  
Potência do sistema: 35W  
Material: alumínio/plástico

- Este produto serve para encastrar em pavimento oco
- Está disponível uma caixa de instalação maior para instalação opcional no solo  
Dimensões de montagem  
C: 14 cm L: 14 cm P: 16 cm



Spot 1 700lm | 3000K  
Spot 2 700lm | 3000K

Versão	Art. n.º	EUR
● Antracite	232185	464,00



Artigo	Art. n.º	EUR
Caixa de instalação 14x14cm		
● Preto	232195	49,50





232135 791



232145 791



## SLOTBOX 40 Pole

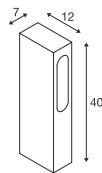

100-277V ~50/60Hz | 700mA  
Potência do sistema: 8W  
Material: alumínio

- Extremidade do cabo aberta



Down 190lm | 3000K

Versão	Art. n.º	EUR
● Antracite	232135	201,00



Artigo	Art. n.º	EUR
Caixa de ligação IP68 3 polos		
● Preto	228730	18,00

## SLOTBOX 70 Pole

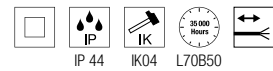
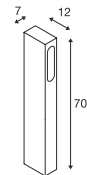

100-277V ~50/60Hz | 700mA  
Potência do sistema: 8,7W  
Material: alumínio

- Extremidade do cabo aberta



Down 190lm | 3000K

Versão	Art. n.º	EUR
● Antracite	232145	242,00



Artigo	Art. n.º	EUR
Caixa de ligação IP68 3 polos		
● Preto	228730	18,00



1002957 793



1002958 793





## FLATT 65 POLE

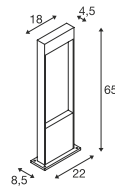

100-240V ~50/60Hz | 350mA  
Potência do sistema: 10W  
Material: alumínio/alumínio

- Extremidade do cabo aberta



Down 400lm | 3000K | 400lm | 4000K

Versão	Art. n.º	EUR
● Antracite	<b>1002956</b>	<b>248,00</b>
● Castanho/antracite	<b>1002957</b>	<b>248,00</b>



Artigo	Art. n.º	EUR
Caixa de ligação IP68 3 polos		
● Preto	<b>228730</b>	<b>18,00</b>

## FLATT 100 POLE

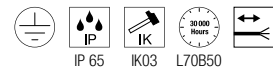
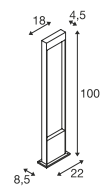

100-240V ~50/60Hz | 350mA  
Potência do sistema: 10W  
Material: alumínio/alumínio

- Extremidade do cabo aberta



Down 400lm | 3000K | 400lm | 4000K

Versão	Art. n.º	EUR
● Antracite	<b>1002958</b>	<b>302,00</b>
● Castanho/antracite	<b>1002959</b>	<b>302,00</b>



Artigo	Art. n.º	EUR
Caixa de ligação IP68 3 polos		
● Preto	<b>228730</b>	<b>18,00</b>



1008727

795



1008726

795



ORDI II  
Pole 45



A partir da primavera de 2025

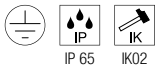

220-240V ~50/60Hz  
Potência do sistema: 10W  
Material: alumínio



Down    700lm | 2200K    700lm | 3000K

Versão	Art. n.º	EUR
● Preto	1008725 ●	259,00

ORDI II  
Pole 70



A partir da primavera de 2025

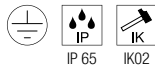

220-240V ~50/60Hz  
Potência do sistema: 10W  
Material: alumínio



Down    700lm | 2200K    700lm | 3000K

Versão	Art. n.º	EUR
● Preto	1008726 ●	299,00

ORDI II  
Pole 70, SENSOR



A partir da primavera de 2025

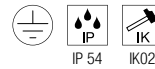

220-240V ~50/60Hz  
Potência do sistema: 10W  
Material: alumínio



Down    700lm | 2200K    700lm | 3000K

Versão	Art. n.º	EUR
● Preto	1008727 ●	309,00

- Funcionalidade primária e de réplica, podem ser ligadas várias luminárias

**ABRIDOR 60**  
Pole, HYBRID

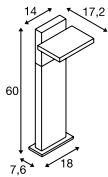

100-240V ~50/60Hz |  
Funcionamento a bateria de 380mA  
Potência do sistema: 6,8W  
Material: alumínio

- Possibilidade de funcionamento solar e com 230 V
- 3 modos diferentes
- Carregamento da bateria através de energia solar
- Extremidade do cabo aberta



Down 600lm | 2200K | 650lm | 2700K

Versão	Art. n.º	EUR
● Antracite	1008543	● 289,00

**ABRIDOR 100**  
Pole 100, HYBRID

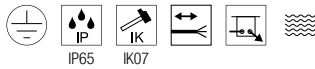
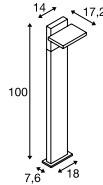

100-240V ~50/60Hz |  
Funcionamento a bateria de 380mA  
Potência do sistema: 6,8W  
Material: alumínio

- Possibilidade de funcionamento solar e com 230 V
- 3 modos diferentes
- Carregamento da bateria através de energia solar
- Extremidade do cabo aberta



Down 600lm | 2200K | 650lm | 2700K

Versão	Art. n.º	EUR
● Antracite	1008544	● 329,00



1002991 797





### ABRIDOR 60 Pole

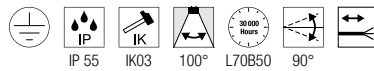
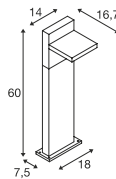

100-240V ~50/60Hz | 300mA  
Potência do sistema: 12W  
Material: alumínio

- Extremidade do cabo aberta



Down 950lm | 3000K | 980lm | 4000K

Versão	Art. n.º	EUR
● Antracite	1002991	222,00



Artigo	Art. n.º	EUR
Caixa de ligações IP68, 5 polos	1006453	35,00
● Preto		

### ABRIDOR 100 Pole

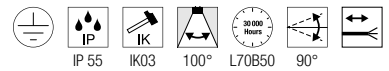
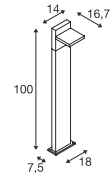

100-240V ~50/60Hz | 300mA  
Potência do sistema: 12W  
Material: alumínio

- Extremidade do cabo aberta



Down 950lm | 3000K | 980lm | 4000K

Versão	Art. n.º	EUR
● Antracite	1002992	282,00



Artigo	Art. n.º	EUR
Caixa de ligações IP68, 5 polos	1006453	35,00
● Preto		



1002992 797

IPERI 50  
Pole

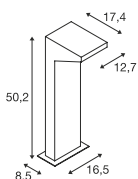

220-240V ~50/60Hz  
Potência do sistema: 4,5W  
Material: alumínio/plástico

- Extremidade do cabo aberta



Down 400lm | 4000K

Versão	Art. n.º	EUR
● Antracite	231305	129,00



Artigo	Art. n.º	EUR
Estaca		
● Cinzento	231231	49,50

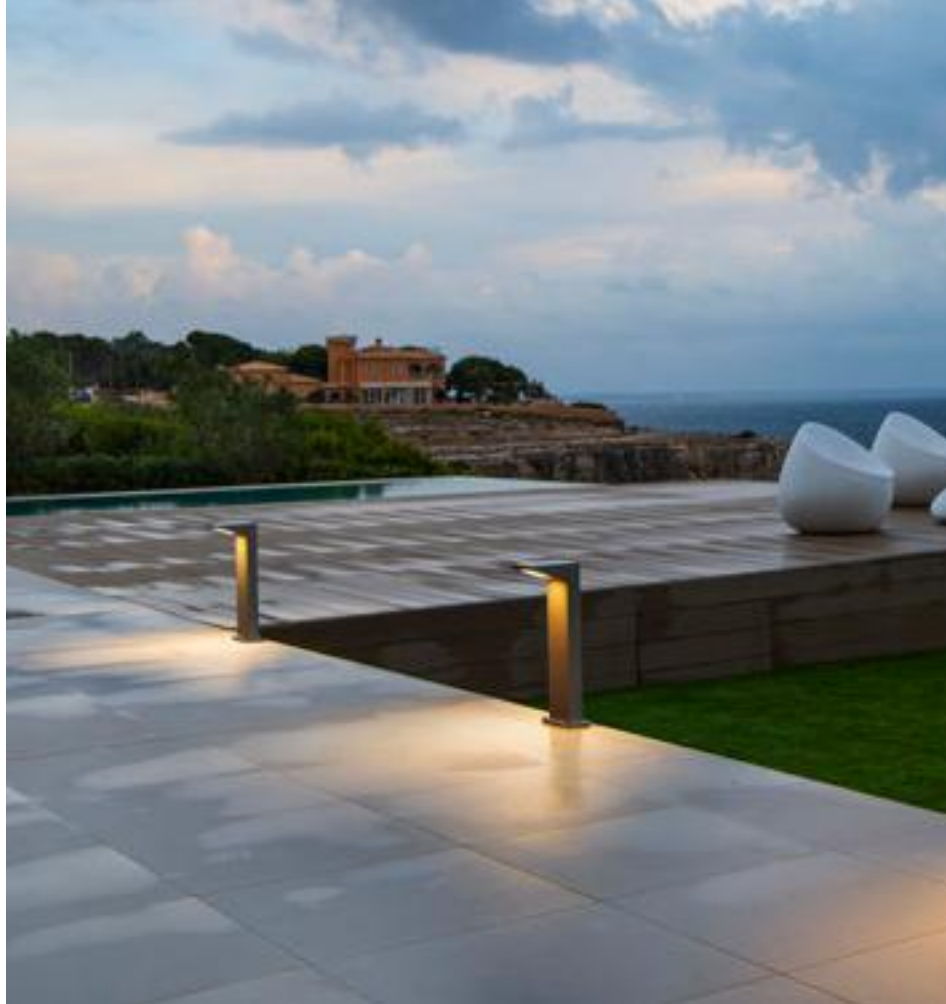

232295 799



## QUADRASYL 75

Pole, TCR-TSE



231305

798

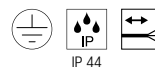
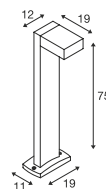

IP 44

220-240V ~50/60Hz  
Material: alumínio

- Âncora de betão incluída.
- Extremidade do cabo aberta

**SOCKET**   
**INSIDE** 

Casquilho: 1xGX53 máx. Ø: 7,5 cm | C: 2,7 cm

Versão	Art. n.º	EUR
● Antracite	232295	164,00
● Cinzento	232294	164,00



LED GX53 | 6,1W | 120°  
3000K | 490lm | CEE=G  
6 kWh/1000h



Art. N.º: 1005271 | 11,50 EUR



Artigo	Art. n.º	EUR
Caixa de conector em T		
● Preto	228726	33,00

## QUAD POLE Pole

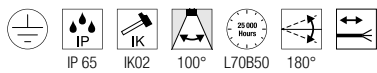
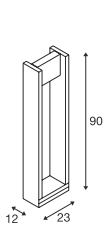

100-277V ~50/60Hz | 500mA  
Potência do sistema: 18W  
Material: alumínio/vidro

- Extremidade do cabo aberta



Down 1550lm | 3000K

Versão	Art. n.º	EUR
● Antracite	1003001	370,00



Artigo	Art. n.º	EUR
Caixa de ligação IP68 3 polos		
● Preto	228730	18,00

## BOOKAT Pole

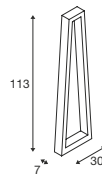

100-277V ~50/60Hz | 700mA  
Potência do sistema: 15W  
Material: alumínio/policarbonato (PC)

- Ligador estanque incluído
- Extremidade do cabo aberta



Down 1240lm | 3000K | 1300lm | 4000K

Versão	Art. n.º	EUR
● Antracite	1005441	403,00



1003001 800



231505 801





**MYRA SPOT**  
Double, GU10

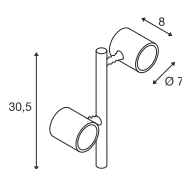

220-240V ~50/60Hz  
Material: alumínio

- A altura da luminária pode ser aumentada, no máximo, com 2 extensores.
- Extremidade do cabo aberta

**SOCKET INSIDE** <4.5 W

Casquilho: 2xGU10 máx. Ø: 5,1 cm | C: 5,7 cm

Versão	Art. n.º	EUR
● Antracite	233185	169,00



LED GU10 51 mm | 6W | 36°  
2200-2700K | 360lm | CEE=G



Art. N.º: 1005075 | 7,50 EUR



Artigo	Art. n.º	EUR
Âncora de betão		
○ Prateado	228712	64,00
Jogo de parafusos		
● Aço inoxidável	228752	6,50
Base		
● Antracite	233145	26,75
Extensor de 30 cm		
● Antracite	233165	26,75

**SITRA 360**  
Pole, TCR-TSE

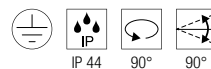
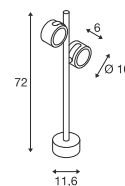

220-240V ~50/60Hz  
Material: alumínio/vidro

- A altura da luminária pode ser aumentada, no máximo, com 2 extensores.
- Extremidade do cabo aberta

**SOCKET INSIDE** <9 W

Casquilho: 2xGX53 máx. Ø: 7,5 cm | C: 3,5 cm

Versão	Art. n.º	EUR
● Antracite	231505	159,00



LED GX53 | 6,1W | 120°  
3000K | 490lm | CEE=G



Art. N.º: 1005271 | 11,50 EUR



Artigo	Art. n.º	EUR
Estaca		
● Cinzento	230060	53,00
Estaca		
● Aço inoxidável	1000736	21,75



1007869 816





NEW



LED  
SYNA | 804

NEW



SCKET  
SYNA | 805



LED  
SYNA PLANT | 807



LED  
SYNA GARDEN | 807



LED  
SYNA | 807



LED  
GALEN 60 | 808



LED  
GALEN 120 | 808



LED  
FLAC BEAM® | 809



SCKET  
SAMRINA | 809



SCKET  
NAUTILUS 10 | 810



SCKET  
BIG NAUTILUS | 810



SCKET  
NAUTILUS 10 | 811



LED  
NAUTILUS 10 | 812



SCKET  
NAUTILUS | 813



SCKET  
NAUTILUS 10  
SPOT | 813



LED  
NAUTILUS 10  
SPOT LED | 813



LED  
DASAR®  
PROJECTOR | 815



LED  
DASAR® 920 | 815

NEW



LED  
HELIA SLIM | 816

NEW



LED  
HELIA SLIM | 816



LED  
HELIA SPOT S | 817



LED  
HELIA SPOT L | 817



SCKET  
THEO BRACKET | 819



LED  
LED SPIKE | 819



SCKET  
SITRA 360 SPIKE | 821



SCKET  
SITRA 360 SPIKE | 821

SYNA  
WIDE, SP

A partir da primavera de 2025



1008480 805



220-240V ~50/60Hz | 500  
Potência do sistema: 5,5W  
Material: alumínio

- Ficha de segurança IP44



Down 500lm | 2200K  
650lm | 3000K

Variante	Art. n.º	EUR
● Preto 500lm   2200K	1008478	69,90
● Preto 650lm   3000K	1008479	69,90



SYNA  
SHADE, SP, GU10A  
partir da  
primavera  
de 2025220-240V ~50/60Hz  
Material: alumínio

- Ficha de segurança IP44

**SOCKET**  
**INSIDE** 10  
W

Casquilho: 1xGU10 Máx. Ø: 5 cm | C: 5,3 cm

Variante	Art. n.º	EUR
● Preto	1008480	● 44,90

QPAR51 | 2,4W | 36°  
2700K | 230lm | CEE=E  
3 kWh/1000 h

Art. N.º: 1007230 | 5,50 EUR

1008480 805



227505 807



1007147 807



## SYNA PLANT SP

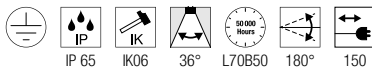
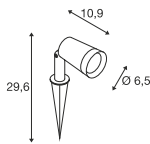

220-240V ~50/60Hz | 250mA  
Potência do sistema: 6W  
Material: alumínio

- Ficha de segurança IP44



Down 540lm | 3000K

Variante	Art. n.º	EUR
● Preto	1007146	65,00

## SYNA GARDEN SP

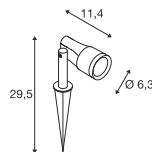

220-240V ~50/60Hz | 250mA  
Potência do sistema: 6W  
Material: alumínio

- Ficha de segurança IP44



Down 540lm | 3000K

Variante	Art. n.º	EUR
● Preto	1007147	69,00

## SYNA SP

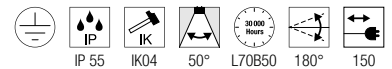
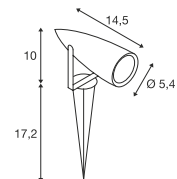

220-240V ~50/60Hz  
Potência do sistema: 9W  
Material: alumínio/acrílico

- Ficha de segurança IP44



Down 470lm | 3000K

Variante	Art. n.º	EUR
● Antracite	227505	80,00

## GALEN 60 SP

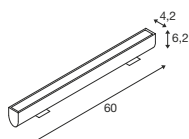

220-240V ~50/60Hz | 450mA  
Potência do sistema: 18W  
Material: alumínio/vidro

- IP67 Plug System



Down 1570lm | 3000K | 1570lm | 4000K

Variante	Art. n.º	EUR
● Antracite	1003447	229,00



Artigo	Art. n.º	EUR
Cabo de ligação 5 m com extremidade do cabo aberta		
● Preto	231960	28,00
Cabo de ligação 1,0 m		
● Preto	231961	19,00

## GALEN 120 SP

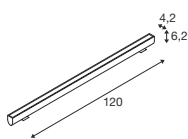

220-240V ~50/60Hz | 900mA  
Potência do sistema: 34W  
Material: alumínio/vidro

- IP67 Plug System



Down 3000lm | 3000K | 3100lm | 4000K

Variante	Art. n.º	EUR
● Antracite	1003448	339,00



Artigo	Art. n.º	EUR
Cabo de ligação 5 m com extremidade do cabo aberta		
● Preto	231960	28,00
Cabo de ligação 1,0 m		
● Preto	231961	19,00







## FLAC BEAM® SP

## SAMRINA SP, single, GU10



1003448 808

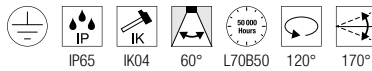
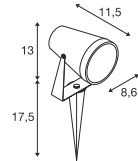
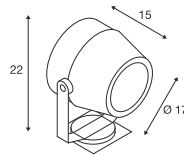

220-240V ~50/60Hz  
Potência do sistema: 27W  
Material: alumínio/vidro

- Ficha de segurança IP44



Down 1600lm | 3000K

Variante	Art. n.º	EUR
● Cinzento	231072	492,00



220-240V ~50/60Hz  
Material: plástico/vidro

- Contém material reciclado
- Ficha de segurança IP44



Casquilho: GU10 Máx. Ø: 6 cm | C: 6 cm

Variante	Art. n.º	EUR
● Preto	1004757	45,50



LED GU10 51 mm | 6W | 38°  
2700K | 450lm | CEE=F  
6 kWh/1000 h



Art. N.º: 1005077 | 7,50 EUR



**NAUTILUS 10**  
SP, Redondo, QPAR51

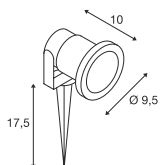

220-240V ~50/60Hz  
Material: alumínio

- Ficha de segurança IP44

**SOCKET INSIDE** <35 W

Casquilho: 1xGU10 máx. C: 5,7 cm

Variante	Art. n.º	EUR
● Cinzento	227418	27,00



LED GU10 51 mm | 6W | 38°  
2700K | 450lm | CEE=F  
6 kWh/1000 h



Art. N.º: 1005077 | 7,50 EUR

**BIG NAUTILUS**  
SP, Redondo, QPAR51

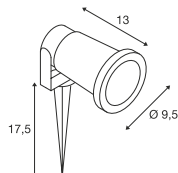

220-240V ~50/60Hz  
Material: alumínio

- Ficha de segurança IP44

**SOCKET INSIDE** <11 W

Casquilho: GU10 máx. Ø: 5,1 cm | C: 8,3 cm

Variante	Art. n.º	EUR
● Preto	227410	30,00
● Oxidado	1001964	30,00
● Verde	1001965	30,00



LED GU10 51 mm | 6W | 38°  
2700K | 450lm | CEE=F  
6 kWh/1000 h



Art. N.º: 1005077 | 7,50 EUR

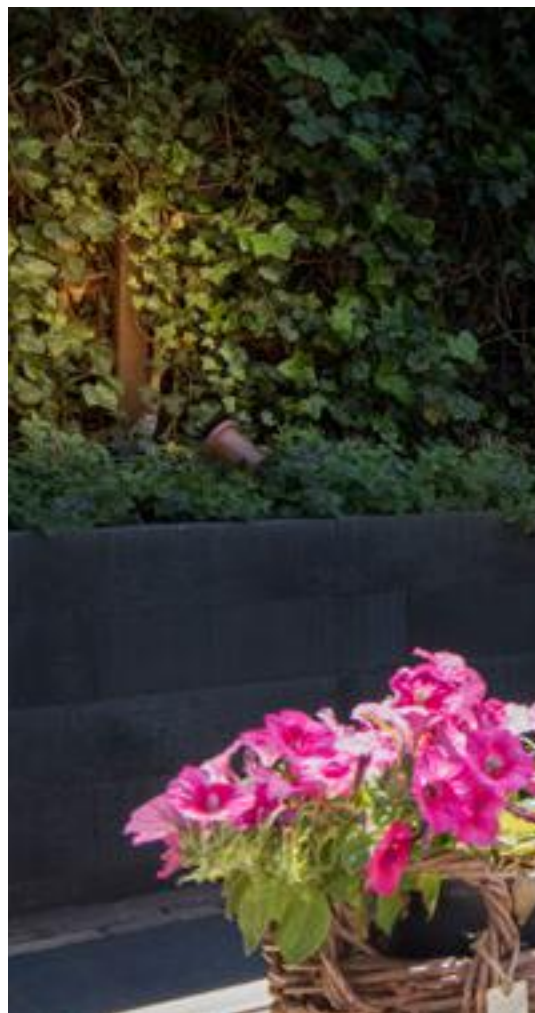



## NAUTILUS 10

SP, Redondo, QPAR51

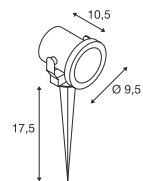

220-240V ~50/60Hz  
Material: aço inoxidável 316

- Ficha de segurança IP44

**SOCKET**  
**INSIDE** <25 W

Casquilho: 1xGU10 máx. Ø: 5,1 cm | C: 5,7 cm

Variante	Art. n.º	EUR
● Aço inoxidável	229740	99,00

1001964 810



LED GU10 51 mm | 6W | 38°  
2700K | 450lm | CEE=F  
6 kWh/1000 h



Art. N.º: 1005077 | 7,50 EUR



231035 812

## NAUTILUS 10 SP, Quadrado

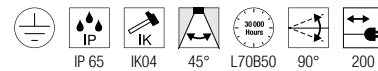
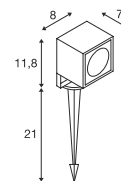

100-277V ~50/60Hz | 700mA  
Potência do sistema: 8,5W  
Material: alumínio/vidro

- Ficha de segurança IP44



Down

660lm | 3000K



1001962 813

Variante	Art. n.º	EUR
● Antracite	231035	145,00



### NAUTILUS SP, QR-C51

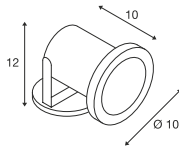

12V ~50Hz  
Material: aço inoxidável 304/vidro

- Extremidade do cabo aberta



Casquilho: 1xGX5.3

Variante	Art. n.º	EUR
● Aço inoxidável	<b>229090</b>	<b>89,00</b>



LED GU5.3 | 5,8W | 36°  
2700K | 450lm | CEE=G  
6 kWh/1000 h

Art. N.º: **1001574** | **35,00 EUR**



### NAUTILUS 10 SPOT SP, QPAR51

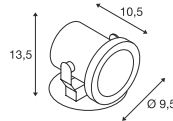

220-240V ~50/60Hz  
Material: aço inoxidável 316

- Extremidade do cabo aberta



Casquilho: 1xGU10 máx. Ø: 5,1 cm | C: 6 cm

Variante	Art. n.º	EUR
● Aço inoxidável	<b>229741</b>	<b>99,00</b>



LED GU10 51 mm | 6W | 38°  
2700K | 450lm | CEE=F  
6 kWh/1000 h

Art. N.º: **1005077** | **7,50 EUR**



Artigo	Art. n.º	EUR
Caixa de ligação IP68 3 pinos		
● Preto	<b>228730</b>	<b>18,00</b>

### NAUTILUS 10 SPOT LED SP

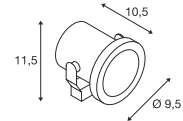

220-240V ~50/60Hz  
Potência do sistema: 9W  
Material: aço inoxidável 316

- Ficha de segurança IP44



Down 520lm | 3000K

Variante	Art. n.º	EUR
● Aço inoxidável	<b>1001962</b>	<b>114,00</b>



Artigo	Art. n.º	EUR
Estaca em plástico		
● Preto	<b>900011</b>	<b>4,00</b>
Placa de montagem		
● Aço inoxidável	<b>1001963</b>	<b>9,05</b>





### DASAR® PROJECTOR SP, 12/24V

### DASAR® 920 SP, 230V

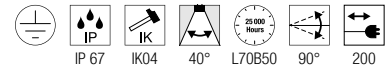
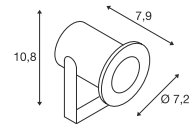
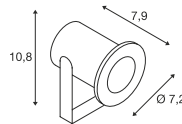

12-24 V DC  
Potência do sistema: 6,5W  
Material: aço inoxidável 316/vidro

220-240V ~50/60Hz | 400mA  
Potência do sistema: 4,6W  
Material: aço inoxidável 316/vidro

- Extremidade do cabo aberta

- Ficha de segurança IP44



Down 520lm | 3000K

Down 300lm | 3000K

Variante	Art. n.º	EUR
● Aço inoxidável	233570	242,00

Variante	Art. n.º	EUR
● Aço inoxidável	233571	302,00



Artigo	Art. n.º	EUR
Estaca em aço inoxidável 316		
● Aço inoxidável	233580	19,00
Estaca em plástico		
● Preto	900011	4,00
Placa de montagem em aço inoxidável 316		
● Aço inoxidável	233582	26,00

Artigo	Art. n.º	EUR
Estaca em aço inoxidável 316		
● Aço inoxidável	233580	19,00
Estaca em plástico		
● Preto	900011	4,00
Placa de montagem em aço inoxidável 316		
● Aço inoxidável	233582	26,00

HELIA SLIM  
Pole, single

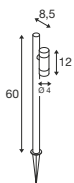

220-240V ~50/60Hz | 500mA  
Potência do sistema: 12W  
Material: alumínio

- Ficha Euro



Down 450lm | 3000K

Variante	Art. n.º	EUR
● Preto	1007868	139,00

HELIA SLIM  
Pole, double

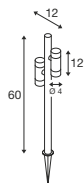

220-240V ~50/60Hz | 500mA  
Potência do sistema: 12W  
Material: alumínio

- Ficha Euro



Up 450lm | 3000K  
Down 450lm | 3000K

Variante	Art. n.º	EUR
● Preto	1007869	169,00



228555

818



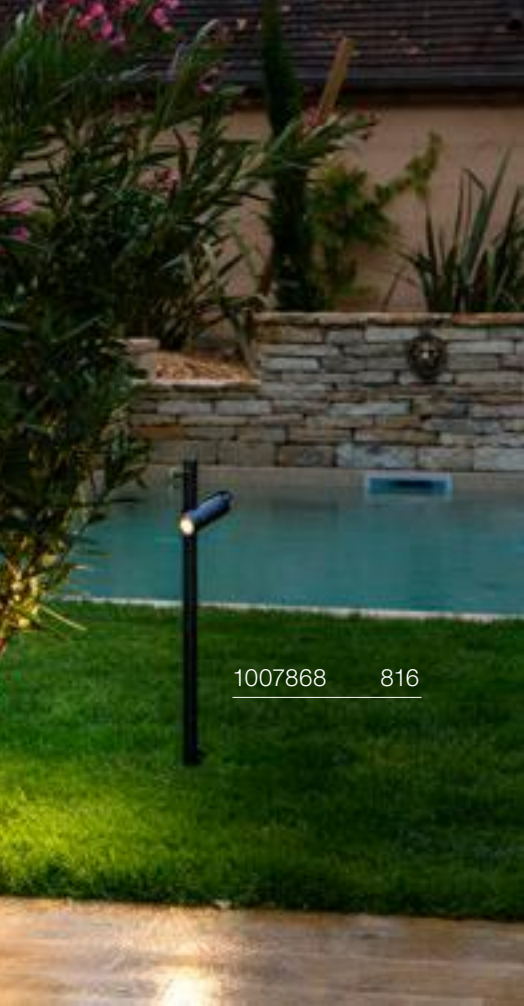

1007868 816



### HELIA SPOT S SP, single

### HELIA SPOT L SP, single, PHASE

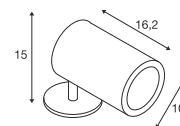
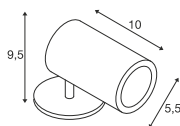

220-240V ~50/60Hz | 500mA  
Potência do sistema: 6,5W  
Material: alumínio

- Ficha de segurança IP44



Down 440lm | 3000K

Variante	Art. n.º	EUR
● Antracite	1000735	176,00



Artigo	Art. n.º	EUR
Estaca		
● Aço inoxidável	1000736	21,75

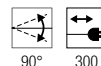
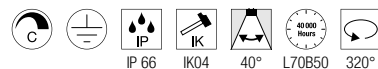

220-240V ~50/60Hz | 700mA  
Potência do sistema: 15W  
Material: alumínio/vidro

- Ficha de segurança IP44



Down 1340lm | 3000K

Variante	Art. n.º	EUR
● Antracite	228555	226,00



Artigo	Art. n.º	EUR
Estaca		
● Aço inoxidável	228560	26,50



1004652 819



1002201 819



## THEO BRACKET SP

## LED SPIKE SP

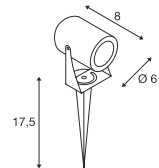
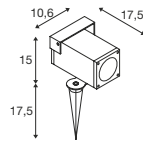

220-240V ~50/60Hz  
Material: alumínio/vidro

100-240V ~50/60Hz | 240mA  
Potência do sistema: 6W  
Material: alumínio/vidro

• Ficha de segurança IP44

• Ficha de segurança IP44



Casquilho: 1xGU10 máx. Ø: 5,1 cm | C: 5,7 cm

Down 400lm | 3000K

Variante	Art. n.º	EUR
● Antracite	1004652	64,00

Variante	Art. n.º	EUR
● Antracite	1002201	70,00
● Oxidado	1002203	70,00



LED GU10 51 mm | 6W | 38°  
2700K | 450lm | CEE=F  
6 kWh/1000 h



Art. N.º: 1005077 | 7,50 EUR





231535 821



SITRA 360 SPIKE  
SP, single, TCR-TSE

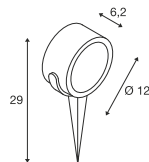

220-240V ~50/60Hz  
Material: alumínio/vidro

- Ficha de segurança IP44



Casquilho: 1xGX53 Máx. Ø: 7,5 cm | C: 3,5 cm

Variante	Art. n.º	EUR
● Antracite	231525	64,00



LED GX53 | 6,1W | 120°  
3000K | 490lm | CEE=G  
6 kWh/1000 h



Art. N.º: 1005271 | 11,50 EUR

SITRA 360 SPIKE  
SP, double, TCR-TSE

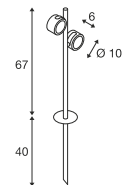

220-240V ~50/60Hz  
Material: alumínio/vidro

- Ficha de segurança IP44



Casquilho: 2xGX53 Máx. Ø: 7,5 cm | C: 3,5 cm

Variante	Art. n.º	EUR
● Antracite	231535	191,00



LED GX53 | 6W | 120°  
2700K | 490lm | CEE=G  
6 kWh/1000 h



Art. N.º: 1005272 | 11,50 EUR

1006327 830





NEW

**SCKET**

PHOTONI CYL | 825



**SCKET**

PHOTONI | 825



**LED**

S-CUBE | 826



**LED**

ESKINA FRAME | 827



**LED**

ENOLA OCULUS | 828



**LED**

ENOLA ROUND S | 829



**LED**

ENOLA ROUND M | 829



**LED**

ENOLA ROUND L | 829



**LED**

ENOLA SQUARE S | 831



**LED**

ENOLA SQUARE M | 831



**LED**

ENOLA SQUARE L | 831



**LED**

BIG THEO | 833



**SCKET**

BIG THEO | 833



**LED**

OVALISK | 833



**SCKET**

MOLAT | 834



**SCKET**

SITRA | 835



**SCKET**

ROX | 837



**SCKET**

ROX | 837

1007586 827







PHOTONI CYL  
CL

PHOTONI  
CL, E27

NEW

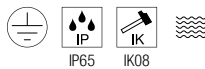
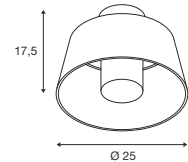
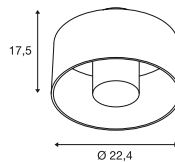

220-240V ~50/60Hz  
Material: alumínio

220-240V ~50/60Hz  
Material: alumínio

**SOCKET** **INSIDE** 13 W



**SOCKET** **INSIDE** <13 W

Casquilho: 1xE27 máx. Ø: 6 cm | C: 11,6 cm



Casquilho: 1xE27 máx. Ø: 6 cm | C: 11,6 cm

Variante	Art. n.º	EUR
● Preto	1008199	99,00
● Oxidado	1008200	99,00

Variante	Art. n.º	EUR
● Preto	1007586	99,00
● Oxidado	1007582	99,00



 LED A60 | 7,5W | 180°  
 2700K | 720lm | CEE=F  
 8 kWh/1000h
 

Art. N.º: 1005305 | 19,00 EUR

 LED E27 | 8W | 240°  
 3000K | 880lm | CEE=E  
 8 kWh/1000h
 

Art. N.º: 1005289 | 10,25 EUR

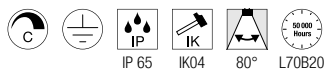
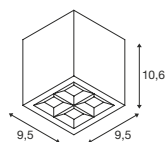
# S-CUBE CL



220-240V ~50/60Hz | 350mA  
Potência do sistema: 15W  
Material: alumínio



Down 1000lm | 2700K | 1200lm | 3000K

Variante	Art. n.º	EUR
● Antracite	1007461	134,00

1007461 828

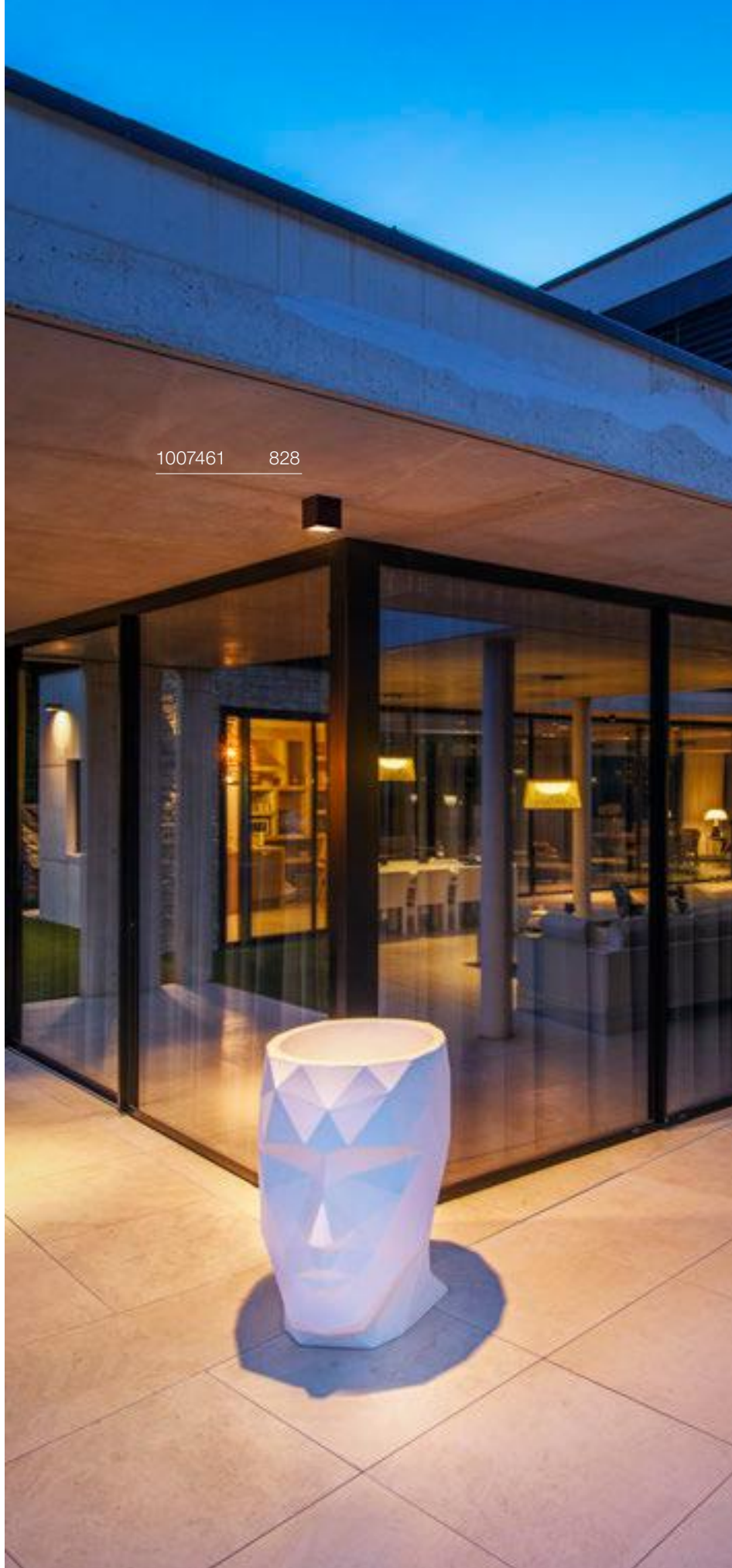



## ESKINA FRAME CL, single



1006316 829

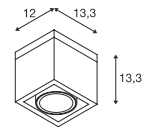

220-240V ~50/60Hz | 350mA  
Potência do sistema: 15W  
Material: alumínio/vidro



Down 1100lm | 3000K | 1200lm | 4000K

Variante	Art. n.º	EUR
● Antracite	1006316	183,00

# ENOLA OCULUS CL

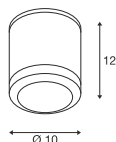

220-240V ~50/60Hz | 500mA  
 Potência do sistema: 11W  
 Material: alumínio/vidro

- A temperatura de cor deve ser definida antes da instalação
- Distribuição da luz convenientemente ajustável utilizando óticas intercambiáveis de 19°, 60° e assimétricas como acessórios



Down 1000lm | 3000K | 1100lm | 4000K

Variante	Art. n.º	EUR
● Antracite	1006327	239,00



Artigo	Art. n.º	EUR
Espaçador		
● Antracite	1003479	9,05



1003427 831



### ENOLA ROUND S CL

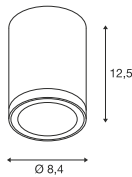

220-240V ~50/60Hz | 500mA  
Potência do sistema: 9W  
Material: alumínio/vidro

- A temperatura de cor deve ser definida antes da instalação



Down 540lm | 3000K | 610lm | 4000K

Variante	Art. n.º	EUR
● Antracite	1003426	172,00



Artigo	Art. n.º	EUR
Espaçador		
● Antracite	1003479	9,05
Refletor 60°		
● Cromado	1005262	16,40

### ENOLA ROUND M CL

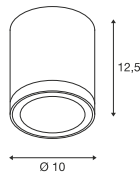

220-240V ~50/60Hz | 500mA  
Potência do sistema: 11W  
Material: alumínio/vidro

- A temperatura de cor deve ser definida antes da instalação
- Distribuição da luz convenientemente ajustável utilizando óticas intercambiáveis de 19°, 60° e assimétricas como acessórios



Down 840lm | 3000K | 960lm | 4000K

Variante	Art. n.º	EUR
● Antracite	1003427	219,00



Artigo	Art. n.º	EUR
Espaçador		
● Antracite	1003479	9,05
Lente de 19°		
● Preto	1005205	41,75
Lente assimétrica		
● Preto/cromado	1005206	41,75
Refletor 60°		
● Cromado	1005207	24,75

### ENOLA ROUND L CL

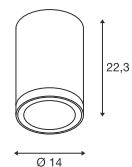

220-240V ~50/60Hz | 900mA  
Potência do sistema: 36W  
Material: alumínio/vidro

- A temperatura de cor deve ser definida antes da instalação
- Distribuição da luz convenientemente ajustável utilizando uma ótica intercambiável de 60° como acessório



Down 3200lm | 3000K | 3500lm | 4000K

Variante	Art. n.º	EUR
● Antracite	1003442	312,00



Artigo	Art. n.º	EUR
Espaçador		
● Antracite	1003479	9,05
Refletor 60°		
● Cromado	1005263	21,50

1003421 833





## ENOLA SQUARE S CL

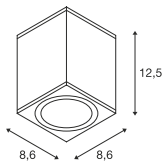

220-240V ~50/60Hz | 500mA  
Potência do sistema: 9W  
Material: alumínio/vidro

- A temperatura de cor deve ser definida antes da instalação



Down 540lm | 3000K | 610lm | 4000K

Variante	Art. n.º	EUR
● Antracite	1003420	172,00



Artigo	Art. n.º	EUR
Espaçador		
● Antracite	1003479	9,05
Refletor 60°		
● Cromado	1005262	16,40

## ENOLA SQUARE M CL

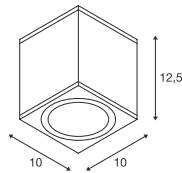

220-240V ~50/60Hz | 500mA  
Potência do sistema: 11W  
Material: alumínio/vidro

- A temperatura de cor deve ser definida antes da instalação
- Distribuição da luz convenientemente ajustável utilizando óticas intercambiáveis de 19°, 60° e assimétricas como acessórios



Down 840lm | 3000K | 960lm | 4000K

Variante	Art. n.º	EUR
● Antracite	1003421	219,00



Artigo	Art. n.º	EUR
Espaçador		
● Antracite	1003479	9,05
Lente de 19°		
● Preto	1005205	41,75
Lente assimétrica		
● Preto/cromado	1005206	41,75
Refletor 60°		
● Cromado	1005207	24,75

## ENOLA SQUARE L CL

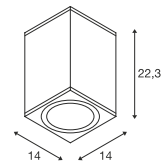

220-240V ~50/60Hz | 900mA  
Potência do sistema: 36W  
Material: alumínio/vidro

- A temperatura de cor deve ser definida antes da instalação
- Distribuição da luz convenientemente ajustável utilizando uma ótica intercambiável de 60° como acessório



Down 3200lm | 3000K | 3500lm | 4000K

Variante	Art. n.º	EUR
● Antracite	1003439	312,00



Artigo	Art. n.º	EUR
Espaçador		
● Antracite	1003479	9,05
Refletor 60°		
● Cromado	1005263	21,50



234535

835



1004677

835





### BIG THEO CL

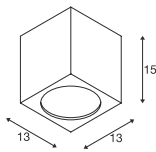

100-277V ~50/60Hz | 500mA  
Potência do sistema: 21W  
Material: alumínio/vidro



Down 2000lm | 3000K

Variante	Art. n.º	EUR
● Antracite	234535	209,00

### BIG THEO CL, QPAR111

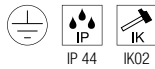
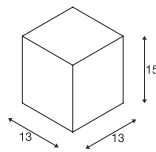

220-240V ~50/60Hz  
Material: alumínio/vidro



Casquilho: 1xGU10

Variante	Art. n.º	EUR
● Antracite	229555	124,00
○ Branco	229551	124,00
● Cinzento	229554	124,00



QPAR111 | 12,5W | 10°  
3000K | 950lm | CEE=F  
13 kWh/1000h



Art. N.º: 1005278 | 55,00 EUR

### OVALISK CL

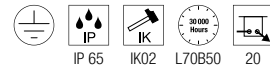
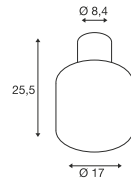

220-240V ~50/60Hz | 350mA  
Potência do sistema: 7,9W  
Material: alumínio/vidro



Down 540lm | 3000K | 570lm | 4000K

Variante	Art. n.º	EUR
● Antracite	1004677	269,00

MOLAT  
CL, E27

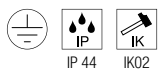
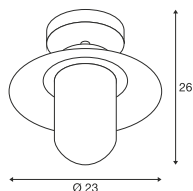

220-240V ~50/60Hz  
Material: alumínio/vidro



Casquilho: 1xE27 máx. Ø: 6,5 cm | C: 14,5 cm

Variante	Art. n.º	EUR
● Antracite	1000823	129,00



LED E27 | 7,5W | 320°  
2500K | 700lm | CEE=F  
8 kWh/1000h



Art. N.º: 1005265 | 26,50 EUR



1000823 836



## SITRA CL, TCR-TSE



231545

837

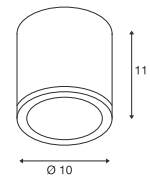

231541

837

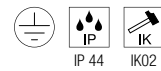

220-240V ~50/60Hz  
Material: alumínio/vidro



Casquilho: 1xGX53 máx. Ø: 7,5 cm | C: 3,5 cm

Variante	Art. n.º	EUR
● Antracite	231545	89,00
○ Branco	231541	89,00



LED GX53 | 6,1W | 120°  
3000K | 490lm | CEE=G  
6 kWh/1000h



Art. N.º: 1005271 | 11,50 EUR

1000332 839





ROX  
CL, QPAR111

ROX  
CL, GX53

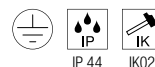
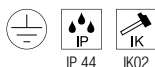
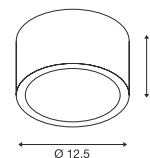
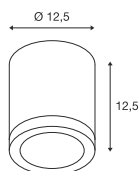

220-240V ~50/60Hz  
Material: alumínio/vidro

220-240V ~50/60Hz  
Material: alumínio/vidro



Casquilho: 1xGU10

Casquilho: 1xGX53 máx. Ø: 7,5 cm | C: 3,5 cm

Variante	Art. n.º	EUR
● Alumínio	1000332	131,00

Variante	Art. n.º	EUR
● Alumínio	1000339	161,00



QPAR111 | 12,5W | 10°  
3000K | 950lm | CEE=F  
13 kWh/1000h



Art. N.º: 1005278 | 55,00 EUR



LED GX53 | 6,1W | 120°  
3000K | 490lm | CEE=G  
6 kWh/1000h



Art. N.º: 1005271 | 11,50 EUR



LED  
R-CUBE | 843



LED  
S-CUBE | 843



NEW  
SCKET  
PHOTONI CYL | 845



SCKET  
PHOTONI | 845



LED  
LID I | 846



LED  
LID I | 846



LED  
LID II | 847



LED  
LID II | 847



NEW  
LED  
Q-RING | 849



NEW  
LED  
Q-RING | 849



NEW  
LED  
D-RING S | 851



NEW  
LED  
D-RING M | 851



LED  
I-RING | 852



LED  
OVAL 14 | 853



LED  
OVAL 18 | 853



LED  
CONCRETO M | 855



LED  
CONCRETO L | 855



LED  
VANO WING | 857



LED  
VANO WING | 857



LED  
MANA BASE | 858



RUSTY® MANA | 858



RUSTY® MANA | 858



LED  
MANA OUT | 859



LED  
MANA OUT | 859



SCKET  
THEO UP/DOWN | 861



LED  
BIG THEO BEAM UP/  
FLOOD DOWN | 861



SCKET  
BIG THEO UP/  
DOWN | 861



SCKET  
THEO | 862



LED  
BIG THEO FLOOD UP/  
DOWN | 862



SCKET  
BIG THEO | 863



LED  
BIG THEO | 863



LED  
ENOLA OCULUS | 865



LED  
ENOLA OCULUS | 865



LED  
ENOLA  
ROUND S | 867



LED  
ENOLA  
ROUND M | 867



LED  
ENOLA  
ROUND L | 867



LED  
ENOLA ROUND S  
UP/DOWN | 869



LED  
ENOLA ROUND M  
UP/DOWN | 869



LED  
ENOLA ROUND L  
UP/DOWN | 869



LED  
ENOLA  
SQUARE S | 871



ENOLA  
SQUARE M | 871



ENOLA  
SQUARE L | 871



LED  
ENOLA SQUARE S  
UP/DOWN | 872



LED  
ENOLA SQUARE M  
UP/DOWN | 872



LED  
ENOLA SQUARE L  
UP/DOWN | 872



LED  
SITRA S | 877



LED  
SITRA S | 877



LED  
SITRA M | 879



LED  
SITRA L | 879



SOCKET  
SITRA CUBE | 879



SOCKET  
GRAFIT | 880



SOCKET  
GRAFIT | 880



SOCKET  
GRAFIT | 881



SOCKET  
GRAFIT | 881



LED  
QUADRULO | 882



SOCKET  
QUADRULO  
SENSOR | 883



SOCKET  
QUADRULO | 883



SOCKET  
MERIDIAN | 884



SOCKET  
MERIDIAN BOX | 884



SOCKET  
MERIDIAN BOX  
SENSOR | 885



SOCKET  
MERIDIAN BOX | 885



LED  
ESKINA FRAME | 887



LED  
ESKINA FRAME | 887



LED  
ESKINA FRAME | 887

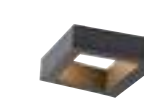

LED  
BOOKAT | 889

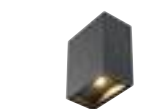

LED  
BIG QUAD | 890



LED  
BIG QUAD  
UP/DOWN | 891



LED  
QUAD | 892



LED  
QUAD  
UP/DOWN 15 | 893

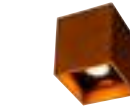

LED  
RUSTY®  
UP/DOWN | 894



LED  
RUSTY®  
UP/DOWN | 894



LED  
OVALISK  
SENSOR | 895



LED  
OVALISK | 895



LED  
PEMA® | 896

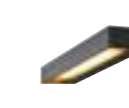

LED  
PEMA® | 897



LED  
PEMA® | 897



SOCKET  
PEMA® | 897



LED  
FLATT | 898



LED  
FLATT SENSOR | 898



SOCKET  
ASTINA | 899



SOCKET  
ASTINA STEEL | 899



LED  
MODELA | 901



LED  
ANGOLUX  
SENSOR | 902

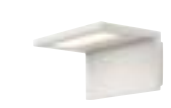

LED  
ANGOLUX | 902

NEW



LED  
VILUA S | 903



LED  
VILUA L | 903



LED  
VILUA | 903



SCKET  
MYRA UP/DOWN | 904



LED  
SITRA UP/DOWN | 905



SCKET  
SITRA UP/DOWN | 905



SCKET  
ROX UP/DOWN | 907



LED  
DELWA | 907



NEW

SCKET  
T-TUBE | 908



NEW

SCKET  
T-TUBE | 908



NEW

SCKET  
T-TUBE | 909



NEW

SCKET  
T-TUBE | 909



SCKET  
WALLYX | 910



LED  
DOWNUNDER  
OUT | 911



LED  
DOWNUNDER  
OUT | 911



NEW

LED  
ABRIDOR | 913



LED  
ABRIDOR | 915



LED  
ABRIDOR  
SENSOR | 915



NEW

LED  
ORDI II SENSOR | 916



NEW

LED  
ORDI II | 916



LED  
ORDI SENSOR | 917



LED  
ORDI | 917



SCKET  
BOX-L | 919



LED  
BOX-L | 919



SCKET  
BOX UP/DOWN | 919



LED  
LOGS | 921



LED  
OUT-BEAM UP/  
FLOOD DOWN | 921



LED  
L-LINE OUT | 921



SCKET  
PHOTONIA | 923



SCKET  
MOLAT | 923



SCKET  
GLOO PURE | 923



SCKET  
F-POL | 924



SCKET  
SQUARE | 925



SCKET  
KERAS ELT | 925



SCKET  
SITRA | 925



LED  
IPERI | 926



SCKET  
QUADRASYL | 927



SCKET  
SQUARE TURN | 927



LED  
TODAY PRO | 929



LED  
ESKINA D | 929



SCKET  
MYRA DISPLAY | 929



LED  
LED SPOT | 931





**SĚCKET**

NAUTILUS | 931



**SĚCKET**

MYRA | 931



**LED**

RASTERLYS | 933



**SĚCKET**

RASTERLYS | 935



**LED**

R-CUBE | 935



**LED**

S-CUBE | 935



**LED**

ESKINA SPOT  
SENSOR | 937



**LED**

ESKINA SPOT | 937



**SĚCKET**

SITRA 360 | 938



**SĚCKET**

THEO BRACKET | 938



**LED**

HELIA | 939



**LED**

HELIA | 939



**SĚCKET**

MYRA | 941



**LED**

OUT-BEAM  
FRAME | 941



**LED**

QUADRULO | 941



**LED**

AINOS | 942



**LED**

AINOS | 943



**LED**

AINOS | 943



**LED**

AINOS | 943



**LED**

RUBA | 944



**LED**

TERANG 200 | 944



**SĚCKET**

BULAN | 945



**SĚCKET**

BULAN GRID | 945



1007511 843



1007458 843

### R-CUBE W

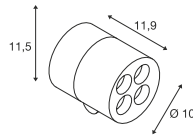

220-240V ~50/60Hz | 350mA  
Potência do sistema: 15W  
Material: alumínio



Down 800lm | 2700K | 800lm | 3000K

Versão	Art. n.º	EUR
● Antracite	1007511	154,00

### S-CUBE CW

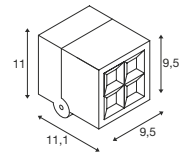

220-240V ~50/60Hz | 350mA  
Potência do sistema: 15W  
Material: alumínio



Down 1000lm | 2700K | 1200lm | 3000K

Versão	Art. n.º	EUR
● Antracite	1007458	154,00

PHOTONI CYL  
WL

NEW

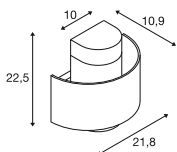

1008197 844

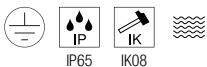

220-240V ~50/60Hz  
Material: alumínio

**SOCKET INSIDE** 13 W

Casquilho: 1xE27 máx. Ø: 6 cm C: 11,6 cm

Versão	Art. n.º	EUR
● Preto	1008197	99,00
● Oxidado	1008198	99,00



LED A60 | 7,5W | 180°  
2700K | 720lm | CEE=F  
8 kWh/1000h



Art. N.º: 1005305 | 19,00 EUR



1007585 845

## PHOTONI WL, E27

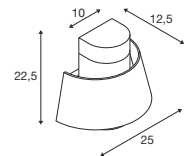

220-240V ~50/60Hz  
Material: alumínio

**SOCKET**  
**INSIDE** <13  
W

Casquilho: 1xE27 máx. Ø: 6 cm | C: 11,6 cm

Versão	Art. n.º	EUR
● Preto	<b>1007585</b>	<b>99,00</b>
● Oxidado	<b>1007581</b>	<b>99,00</b>



LED E27 | 8W | 240°  
3000K | 880lm | CEE=E  
8 kWh/1000h



Art. N.º: **1005289** | **10,25 EUR**



LID I  
WL, single

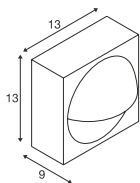

220-240V ~50/60Hz | 350mA  
Potência do sistema: 15W  
Material: alumínio



Down 900lm | 2700K | 1050lm | 3000K

Versão	Art. n.º	EUR
● Antracite	1007667	144,00

LID I  
WL, double

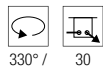
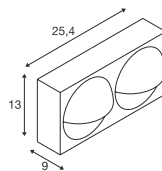

220-240V ~50/60Hz | 700mA  
Potência do sistema: 29W  
Material: alumínio



Spot 1 850lm | 2700K | 1000lm | 3000K  
Spot 2 850lm | 2700K | 1000lm | 3000K

Versão	Art. n.º	EUR
● Antracite	1007668	229,00



## LID II

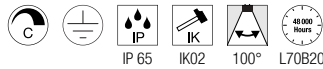
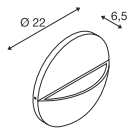

220-240V ~50/60Hz | 350mA  
Potência do sistema: 15W  
Material: alumínio



Down 800lm | 2700K | 800lm | 3000K

Versão	Art. n.º	EUR
● Antracite	1007282	109,00

## LID II WL. up/down

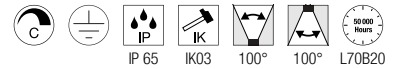
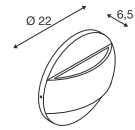
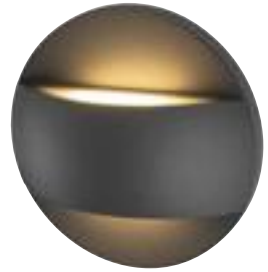

220-240V ~50/60Hz | 700mA  
Potência do sistema: 28W  
Material: alumínio



Up 750lm | 2700K | 750lm | 3000K  
Down 750lm | 2700K | 750lm | 3000K

Versão	Art. n.º	EUR
● Antracite	1007281	129,00

1007281 847



1007916 849





Q-RING  
WL

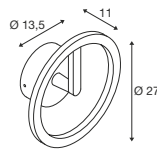

220-240V ~50/60Hz | 240mA  
Potência do sistema: 10W  
Material: alumínio/plástico



Down 950lm | 3000K

Versão	Art. n.º	EUR
● Preto	1007918	159,00
○ Branco	1007919	159,00

Q-RING  
WL. Sensor

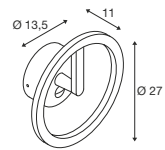

220-240V ~50/60Hz | 240mA  
Potência do sistema: 10W  
Material: alumínio/plástico



Down 950lm | 3000K

Versão	Art. n.º	EUR
● Preto	1007916	179,00
○ Branco	1007917	179,00

1007912 851



1007914 851



### D-RING S WL, PHASE

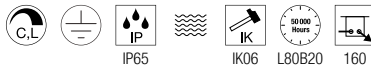
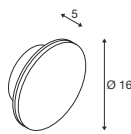

220-240V ~50Hz | 95mA  
Potência do sistema: 7,5W  
Material: alumínio



Down 630lm | 2700K | 650lm | 3000K

Versão	Art. n.º	EUR
● Preto 630/650lm	1007911	99,00
○ Branco 790/820lm	1007912	99,00

### D-RING M WL, PHASE

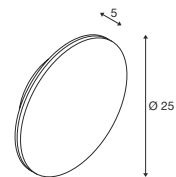

220-240V ~50Hz | 190mA  
Potência do sistema: 15W  
Material: alumínio



Down 1540lm | 2700K | 1590lm | 3000K

Versão	Art. n.º	EUR
● Preto 1260/1360lm	1007913	149,00
○ Branco 1540/1590lm	1007914	149,00

## I-RING WL



1007236 852

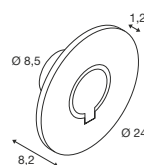

100-240V ~50/60Hz | 350mA  
Potência do sistema: 9,2W  
Material: alumínio



Down

670lm | 3000K

Versão	Art. n.º	EUR
● Antracite	1007236	164,00

**OVAL 14**  
WL, up/down

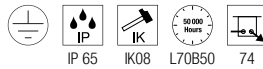
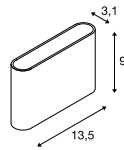

220-240V ~50/60Hz | 145mA  
Potência do sistema: 5,7W  
Material: alumínio/policarbonato (PC)



Up	280lm	2700K	280lm	3000K
Down	280lm	2700K	280lm	3000K

Versão	Art. n.º	EUR
● Preto	<b>1007142</b>	<b>73,00</b>
○ Branco	<b>1007143</b>	<b>73,00</b>

**OVAL 18**  
WL, up/down

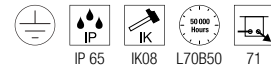
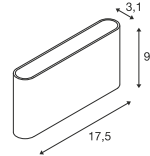

220-240V ~50/60Hz | 275mA  
Potência do sistema: 9,3W  
Material: alumínio/policarbonato (PC)



Up	430lm	2700K	430lm	3000K
Down	430lm	2700K	430lm	3000K

Versão	Art. n.º	EUR
● Preto	<b>1007144</b>	<b>87,00</b>
○ Branco	<b>1007145</b>	<b>87,00</b>

1006405 855



CONCRETO M  
WL

CONCRETO L  
WL

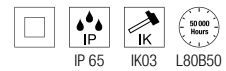
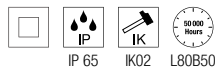
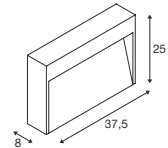
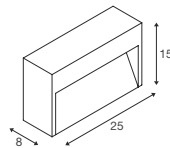

220-240V ~50/60Hz | 700mA  
Potência do sistema: 8,5W  
Material: betão/alumínio

220-240V ~50/60Hz | 700mA  
Potência do sistema: 12W  
Material: betão/alumínio



Down 270lm | 3000K

Down 470lm | 3000K

Versão	Art. n.º	EUR
● Cinzento	1006404	200,00

Versão	Art. n.º	EUR
● Cinzento	1006405	260,00



1006270 857



### VANO WING SP, DALI

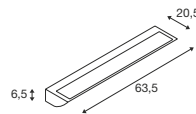

220-240V ~50/60Hz | 500mA  
Potência do sistema: 25W  
Material: alumínio/vidro



Down 1400lm | 3000K

Versão	Art. n.º	EUR
● Cinzento	1006268	429,00

### VANO WING SP, DALI

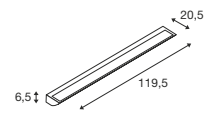

220-240V ~50/60Hz | 1050mA  
Potência do sistema: 49W  
Material: alumínio/vidro



Down 3140lm | 3000K

Versão	Art. n.º	EUR
● Cinzento	1006270	529,00

MANA BASE  
WL, Redondo, PHASE

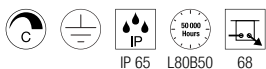
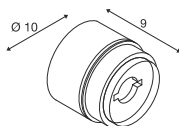

220-240V ~50/60Hz | 350mA  
Potência do sistema: 15W  
Material: alumínio/policarbonato (PC)



Down 800lm | 2700K | 820lm | 3000K

Versão	Art. n.º	EUR
● Antracite	1006319	189,00

RUSTY® MANA  
Abajur, quadrado



C: 28 cm L: 28 cm A: 1,5 cm  
Material: aço FeCSi

Versão	Art. n.º	EUR
● Oxidado	1006317	59,00

RUSTY® MANA  
Abajur, redondo



A: 1,5 cm  
Ø: 28 cm  
Material: aço FeCSi

Versão	Art. n.º	EUR
● Oxidado	1006318	59,00

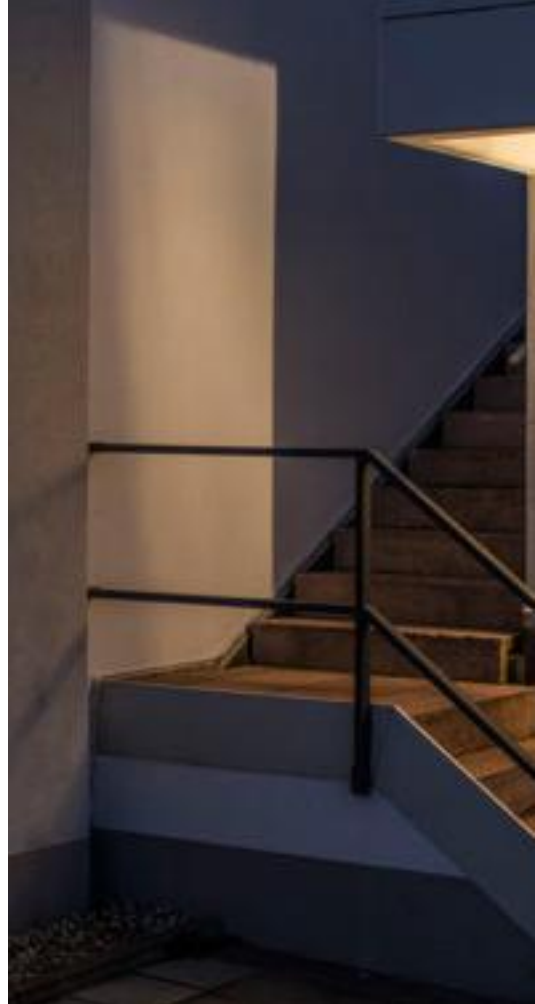

1003470 859

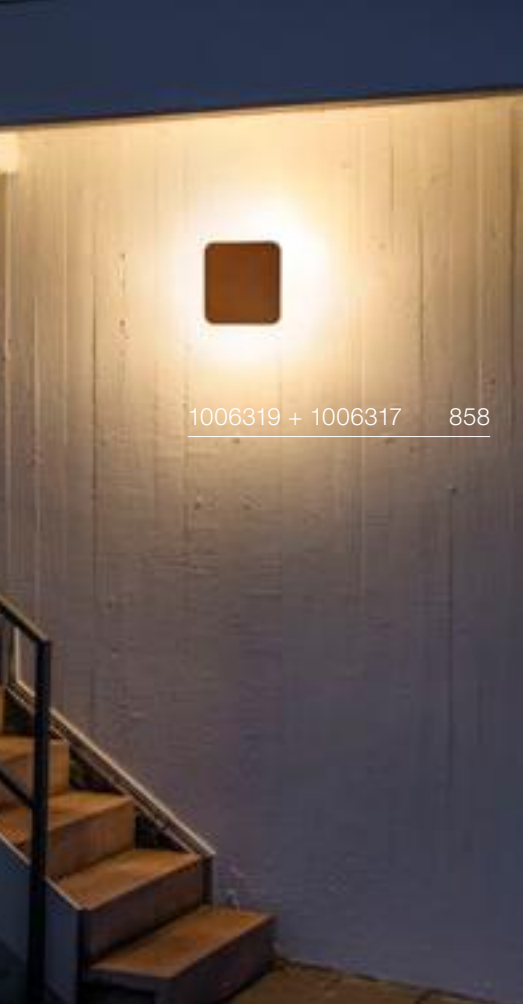

1006319 + 1006317 858

### MANA OUT WL, PHASE

### MANA OUT WL, conjunto

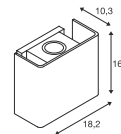
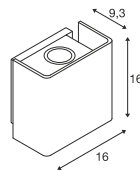

220-240V ~50/60Hz | 500mA  
Potência do sistema: 11W  
Material: alumínio/alumínio

220-240V ~50/60Hz | 500mA  
Potência do sistema: 11W  
Material: alumínio/betão

- Incl. 2 protetores para SPOT

- Incl. 2 protetores para SPOT



Up 325lm | 3000K  
Down 325lm | 3000K

Up 325lm | 3000K  
Down 325lm | 3000K

Versão	Art. n.º	EUR
● Antracite	1002900	239,00

Versão	Art. n.º	EUR
● Cinzento	1003470	274,00





229532 861



234515 861



### THEO UP/DOWN WL, QPAR51

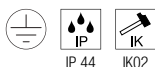
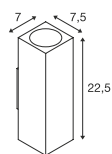

220-240V ~50/60Hz  
Material: alumínio/vidro



Casquiho: 2xGU10

Versão	Art. n.º	EUR
● Antracite	229535	89,00
○ Branco	229531	89,00
● Cinzento	229532	89,00



LED GU10 51 mm | 6W | 36°  
2200-2700K | 360lm | CEE=G  
6 kWh/1000h



Art. N.º: 1005273 | 9,99 EUR

### BIG THEO BEAM UP/ FLOOD DOWN WL

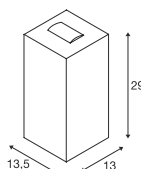

220-240V ~50/60Hz | 500mA  
Potência do sistema: 29W  
Material: alumínio/vidro

- O efeito de luz de 2° é particularmente adequado para definir o contorno e a estrutura de superfícies altas e fachadas de edifícios, assim como de hotéis, restaurantes ou até blocos de apartamentos e centros comerciais.



Up Down 130lm | 2000lm | 3000K

Versão	Art. n.º	EUR
● Antracite	234515	279,00

### BIG THEO UP/DOWN WL, QPAR111

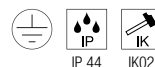
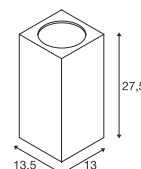

220-240V ~50/60Hz  
Material: alumínio/vidro



Casquiho: 2xGU10

Versão	Art. n.º	EUR
● Antracite	229575	179,00
● Cinzento	229574	179,00



QPAR111 | 12,5W | 10°  
3000K | 950lm | CEE=F  
13 kWh/1000h



Art. N.º: 1005278 | 55,00 EUR

THEO  
WL, QPAR51

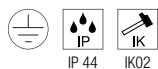
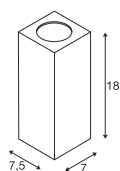

220-240V ~50/60Hz  
Material: alumínio/vidro



Casquilho: 1xGU10

Versão	Art. n.º	EUR
● Antracite	229525	74,00
● Cinzento	229524	74,00



LED GU10 51 mm | 6W | 36°  
2200-2700K | 360lm | CEE=G  
6 kWh/1000h



Art. N.º: 1005273 | 9,99 EUR

BIG THEO FLOOD UP/DOWN  
WL

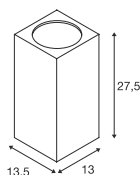

220-240V ~50/60Hz | 1000mA  
Potência do sistema: 42W  
Material: alumínio/vidro



Up 2000lm | 3000K  
Down 2000lm | 3000K

Versão	Art. n.º	EUR
● Antracite	234505	314,00





BIG THEO  
WL, QPAR111

BIG THEO  
WL

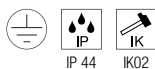
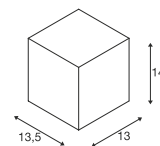
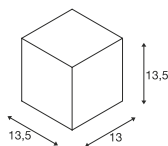
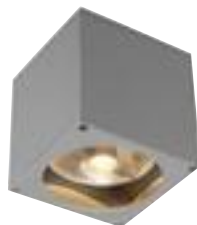

220-240V ~50/60Hz  
Material: alumínio/vidro



Casquilho: 1xGU10

Versão	Art. n.º	EUR
● Antracite	229565	113,00
● Cinzento	229564	113,00



QPAR111 | 12,5W | 10°  
3000K | 950lm | CEE=F  
13 kWh/1000h

Art. N.º: 1005278 | 55,00 EUR



100-277V ~50/60Hz | 500mA  
Potência do sistema: 21W  
Material: alumínio/vidro



Down 2000lm | 3000K

Versão	Art. n.º	EUR
● Antracite	234525	224,00

1006328 865





### ENOLA OCULUS WL, single

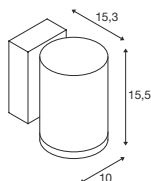

220-240V ~50/60Hz | 500mA  
Potência do sistema: 11W  
Material: alumínio/vidro

- A temperatura de cor deve ser definida antes da instalação
- A ótica Oculus cria um efeito de luz contornado e bem definido na respetiva superfície



Down 1000lm | 3000K | 1100lm | 4000K

Versão	Art. n.º	EUR
● Antracite	1006328	273,00



Artigo	Art. n.º	EUR
Espaçador		
● Antracite	1002853	7,75

### ENOLA OCULUS WL, up/down

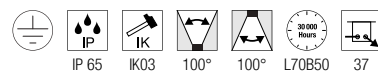
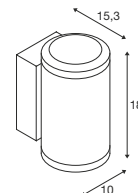

220-240V ~50/60Hz | 500mA  
Potência do sistema: 20W  
Material: alumínio/vidro

- A temperatura de cor deve ser definida antes da instalação
- A ótica Oculus cria um efeito de luz contornado e bem definido na respetiva superfície



Up 940lm | 3000K | 1060lm | 4000K  
Down 940lm | 3000K | 1060lm | 4000K

Versão	Art. n.º	EUR
● Antracite	1006329	344,00



Artigo	Art. n.º	EUR
Espaçador		
● Antracite	1002853	7,75

1003440 867



### ENOLA ROUND S WL, single

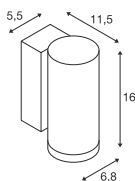

100-240V ~50/60Hz | 500mA  
Potência do sistema: 6W  
Material: alumínio/vidro

- A temperatura de cor deve ser definida antes da instalação
- Distribuição da luz convenientemente ajustável utilizando uma ótica intercambiável de 60° como acessório



Down 450lm | 3000K | 500lm | 4000K

Versão	Art. n.º	EUR
● Antracite	1003422	200,00



Artigo	Art. n.º	EUR
Espaçador		
● Antracite	1002853	7,75
Refletor 60°		
● Cromado	1005262	16,40

### ENOLA ROUND M WL, single

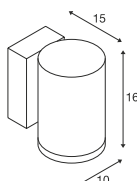

220-240V ~50/60Hz | 500mA  
Potência do sistema: 11W  
Material: alumínio/vidro

- A temperatura de cor deve ser definida antes da instalação
- Distribuição da luz convenientemente ajustável utilizando óticas intercambiáveis de 19°, 60° e assimétricas como acessórios



Down 860lm | 3000K | 980lm | 4000K

Versão	Art. n.º	EUR
● Antracite	1003423	245,00



Artigo	Art. n.º	EUR
Espaçador		
● Antracite	1002853	7,75
Lente de 19°		
● Preto	1005205	41,75
Lente assimétrica		
● Preto/cromado	1005206	41,75
Refletor 60°		
● Cromado	1005207	24,75

### ENOLA ROUND L WL, single

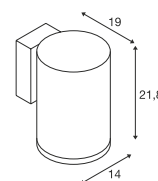

220-240V ~50/60Hz | 900mA  
Potência do sistema: 36W  
Material: alumínio/vidro

- A temperatura de cor deve ser definida antes da instalação
- Distribuição da luz convenientemente ajustável utilizando uma ótica intercambiável de 60° como acessório



Down 3300lm | 3000K | 3700lm | 4000K

Versão	Art. n.º	EUR
● Antracite	1003440	343,00



Artigo	Art. n.º	EUR
Espaçador		
● Antracite	1002853	7,75
Refletor 60°		
● Cromado	1005263	21,50

1003441 869



### ENOLA ROUND S UP/DOWN WL

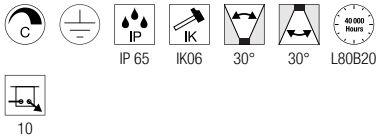
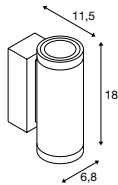

220-240V ~50/60Hz | 350mA  
Potência do sistema: 7,8W  
Material: alumínio/vidro

- A temperatura de cor deve ser definida antes da instalação
- Distribuição da luz convenientemente ajustável utilizando uma ótica intercambiável de 60° como acessório



Up	310lm	3000K	350lm	4000K
Down	310lm	3000K	350lm	4000K

Versão	Art. n.º	EUR
● Antracite	1003424	245,00



Artigo	Art. n.º	EUR
Espaçador		
● Antracite	1002853	7,75
Refletor 60°		
● Cromado	1005262	16,40

### ENOLA ROUND M UP/DOWN WL

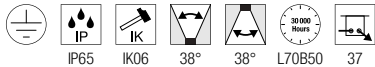
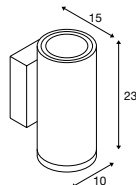

220-240V ~50/60Hz | 500mA  
Potência do sistema: 19W  
Material: alumínio/vidro

- A temperatura de cor deve ser definida antes da instalação
- Distribuição da luz convenientemente ajustável utilizando óticas intercambiáveis de 19°, 60° e assimétricas como acessórios



Up	830lm	3000K	950lm	4000K
Down	830lm	3000K	950lm	4000K

Versão	Art. n.º	EUR
● Antracite	1003425	300,00



Artigo	Art. n.º	EUR
Espaçador		
● Antracite	1002853	7,75
Lente de 19°		
● Preto	1005205	41,75
Lente assimétrica		
● Preto/cromado	1005206	41,75
Refletor 60°		
● Cromado	1005207	24,75

### ENOLA ROUND L UP/DOWN WL

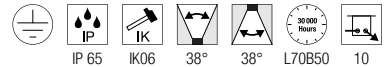
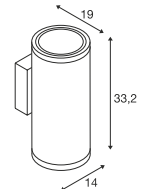

220-240V ~50/60Hz | 700mA  
Potência do sistema: 55W  
Material: alumínio/vidro

- A temperatura de cor deve ser definida antes da instalação
- Distribuição da luz convenientemente ajustável utilizando uma ótica intercambiável de 60° como acessório



Up	2700lm	3000K	3000lm	4000K
Down	2700lm	3000K	3000lm	4000K

Versão	Art. n.º	EUR
● Antracite	1003441	470,00



Artigo	Art. n.º	EUR
Espaçador		
● Antracite	1002853	7,75
Refletor 60°		
● Cromado	1005263	21,50



1003416 871



1006417 871

### ENOLA SQUARE S WL, single

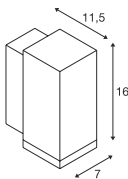

100-240V ~50/60Hz | 500mA  
Potência do sistema: 6W  
Material: alumínio/vidro

- A temperatura de cor deve ser definida antes da instalação
- Distribuição da luz convenientemente ajustável utilizando uma ótica intercambiável de 60° como acessório



Down 450lm | 3000K | 500lm | 4000K

Versão	Art. n.º	EUR
● Antracite	1003416	200,00



Artigo	Art. n.º	EUR
Espaçador		
● Antracite	1002853	7,75
Refletor 60°		
● Cromado	1005262	16,40

### ENOLA SQUARE M WL, single

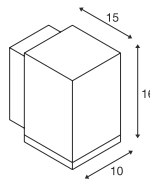

220-240V ~50/60Hz | 500mA  
Potência do sistema: 11W  
Material: alumínio/vidro

- A temperatura de cor deve ser definida antes da instalação
- Distribuição da luz convenientemente ajustável utilizando óticas intercambiáveis de 19°, 60° e assimétricas como acessórios



Down 860lm | 3000K | 980lm | 4000K

Versão	Art. n.º	EUR
● Antracite	1003417	245,00



Artigo	Art. n.º	EUR
Espaçador		
● Antracite	1002853	7,75
Lente de 19°		
● Preto	1005205	41,75
Lente assimétrica		
● Preto/cromado	1005206	41,75
Refletor 60°		
● Cromado	1005207	24,75

### ENOLA SQUARE L WL, single

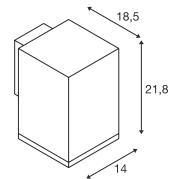

220-240V ~50/60Hz | 900mA  
Potência do sistema: 36W  
Material: alumínio/vidro

- A temperatura de cor deve ser definida antes da instalação
- Distribuição da luz convenientemente ajustável utilizando uma ótica intercambiável de 60° como acessório



Down 3300lm | 3000K | 3700lm | 4000K

Versão	Art. n.º	EUR
● Antracite	1003437	343,00



Artigo	Art. n.º	EUR
Espaçador		
● Antracite	1002853	7,75
Refletor 60°		
● Cromado	1005263	21,50

## ENOLA SQUARE S UP/DOWN WL

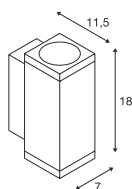

220-240V ~50/60Hz | 350mA  
Potência do sistema: 7,8W  
Material: alumínio/vidro

- A temperatura de cor deve ser definida antes da instalação
- Distribuição da luz convenientemente ajustável utilizando uma ótica intercambiável de 60° como acessório



Up	310lm	3000K	350lm	4000K
Down	310lm	3000K	350lm	4000K

Versão	Art. n.º	EUR
● Antracite	1003418	245,00



Artigo	Art. n.º	EUR
Espaçador		
● Antracite	1002853	7,75
Refletor 60°		
● Cromado	1005262	16,40

## ENOLA SQUARE M UP/DOWN WL

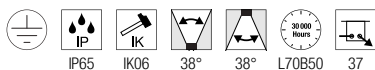
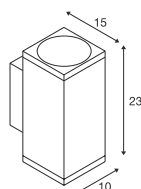

220-240V ~50/60Hz | 500mA  
Potência do sistema: 19W  
Material: alumínio/vidro

- A temperatura de cor deve ser definida antes da instalação
- Distribuição da luz convenientemente ajustável utilizando óticas intercambiáveis de 19°, 60° e assimétricas como acessórios



Up	830lm	3000K	950lm	4000K
Down	830lm	3000K	950lm	4000K

Versão	Art. n.º	EUR
● Antracite	1003419	300,00



Artigo	Art. n.º	EUR
Espaçador		
● Antracite	1002853	7,75
Lente de 19°		
● Preto	1005205	41,75
Lente assimétrica		
● Preto/cromado	1005206	41,75
Refletor 60°		
● Cromado	1005207	24,75

## ENOLA SQUARE L UP/DOWN WL

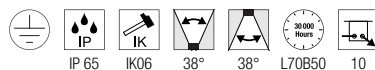
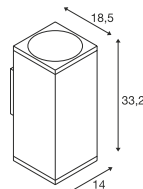

220-240V ~50/60Hz | 700mA  
Potência do sistema: 55W  
Material: alumínio/vidro

- A temperatura de cor deve ser definida antes da instalação
- Distribuição da luz convenientemente ajustável utilizando uma ótica intercambiável de 60° como acessório



Up	2700lm	3000K	3000lm	4000K
Down	2700lm	3000K	3000lm	4000K

Versão	Art. n.º	EUR
● Antracite	1003438	470,00



Artigo	Art. n.º	EUR
Espaçador		
● Antracite	1002853	7,75
Refletor 60°		
● Cromado	1005263	21,50





ENOLA S/M/L  
Refletor



60°

**S** | A: 1,85 cm Ø: 4,5 cm  
**M** | A: 4 cm Ø: 7,5 cm  
**L** | A: 6,96 cm Ø: 11 cm  
 Material: policarbonato (PC)

ENOLA M  
Lente de 34°



34/12°

A: 3,8 cm  
 Ø: 7,5 cm  
 Material: aço/policarbonato (PC)

ENOLA M  
Lente assimétrica



23°

A: 3 cm  
 Ø: 7,5 cm  
 Material: aço/policarbonato (PC)

Versão	Art. n.º	EUR
● Cromado   <b>S</b>	1005262	16,40
● Cromado   <b>M</b>	1005207	24,75
● Cromado   <b>L</b>	1005263	21,50

Versão	Art. n.º	EUR
● Preto	1005205	41,75

Versão	Art. n.º	EUR
●● Preto/cromado	1005206	41,75

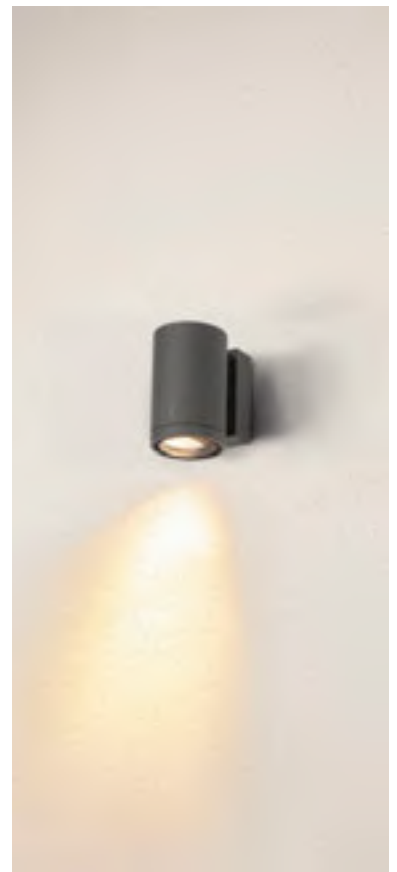

# EASY TO INSTALL

---

1

## MONTAGEM NA PAREDE.

Aparafusar a placa de montagem na parede com os parafusos de fixação.

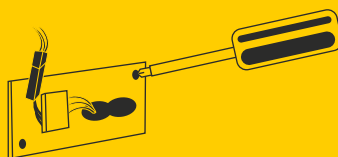

2

## LIGAÇÃO SIMPLES.

Ligar o conector da fonte de alimentação às luminárias LED.

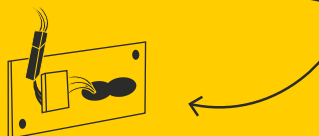

3

## MONTAGEM LIMPA E SEGURA.

Montar a luminária na ranhura de guia prática da placa de montagem e aparafusar o corpo da luminária à placa de montagem.



## JÁ ESTÁ!

Como a eficiência compensa sempre, as luminárias SLV são de instalação fácil, rápida e segura. Com placas de montagem fixas, cabeças de luminária encaixáveis, ligações com grampo de mola, cablagens, entradas de cabo e outros recursos, oferecem vantagens decisivas: economia de tempo, esforço e custos.

## CABEÇAS DE LUMINÁRIA ENCAIXÁVEIS.

Também na nossa gama ENOLA,<sup>®</sup> a cabeça da luminária pode ser separada da placa de montagem fixada na parede. Isso significa que, após a suspensão pelo nariz integrado e a ligação elétrica através do conector, as duas mãos permanecem livres para aparafusar com segurança a luminária.

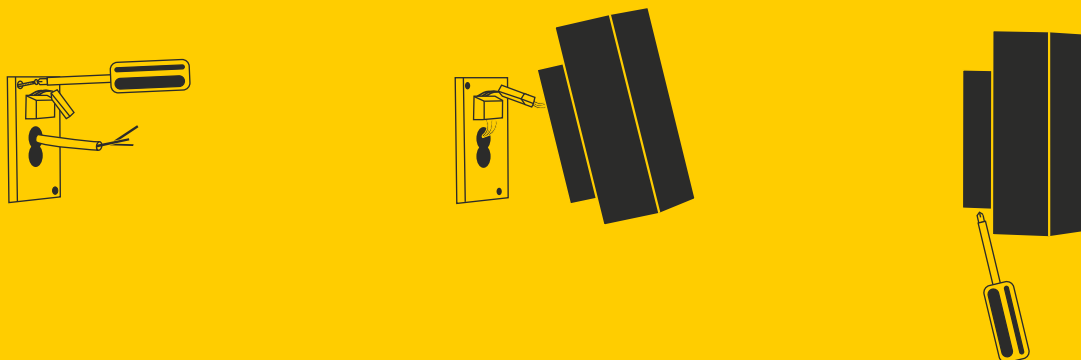

## LIGAÇÕES COM GRAMPO DE MOLA PRÁTICAS.

As luminárias de parede SITRA CUBE em forma de cubo impressionam pela sua simplicidade moderna. Também são instaladas de forma rápida e fácil: basta prender o cabo de ligação diretamente sem ferramentas e ligar o acoplamento da placa de montagem à ficha elétrica da luminária – e já está!



## LIGAÇÃO PERMANENTE DA CABLAGEM.

As nossas luminárias de parede e teto QUADRULO mostram que na prática funcionamento da cablagem é simples. Isto porque estão previstas duas entradas de cabo em forma de 8 na base da placa. Para além de duas entradas de cabos, o terminal de mola também tem duas opções de ligação. Assim, várias luminárias podem ser instaladas de forma rápida e fácil em simultâneo.





1005149 877

SITRA S  
WL, single, Quadrado

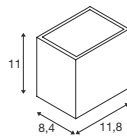

220-240V ~50/60Hz | 500mA  
Potência do sistema: 6,2W  
Material: alumínio



Down 580lm | 3000K | 620lm | 4000K

Versão	Art. n.º	EUR
● Antracite	1005148	99,00
○ Branco	1005149	99,00
● Oxidado	1005150	99,00

SITRA S  
WL, single, Quadrado

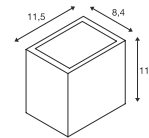

100-277V ~50/60Hz | 500mA  
Potência do sistema: 11W  
Material: alumínio



Up Down 550lm | 3000K | 635lm | 4000K  
550lm | 3000K | 635lm | 4000K

Versão	Art. n.º	EUR
● Antracite	1002032	119,00
○ Branco	1002033	119,00
● Oxidado	1002034	119,00



232531 879



232535 879



**SITRA M**  
WL, up/down, Quadrado

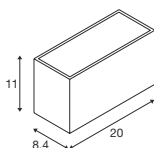

220-240V ~50/60Hz | 350mA  
Potência do sistema: 14W  
Material: alumínio



Up	850lm	3000K	940lm	4000K
Down	850lm	3000K	940lm	4000K

Versão	Art. n.º	EUR
● Antracite	1005151	144,00
○ Branco	1005153	144,00
● Oxidado	1005154	144,00

**SITRA L**  
WL, up/down, Quadrado

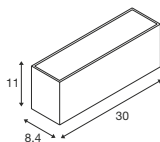

220-240V ~50/60Hz | 600mA  
Potência do sistema: 24W  
Material: alumínio



Up	1400lm	3000K	1530lm	4000K
Down	1400lm	3000K	1530lm	4000K

Versão	Art. n.º	EUR
● Antracite	1005155	184,00
○ Branco	1005156	184,00
● Oxidado	1005157	184,00

**SITRA CUBE**  
WL, TCR-TSE, up/down

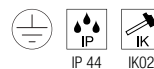
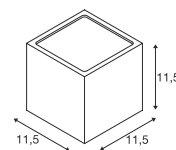

220-240V ~50/60Hz  
Material: alumínio/vidro



Casquilho: 2xGX53 máx. Ø: 7,5 cm | C: 2,7 cm

Versão	Art. n.º	EUR
● Antracite	232535	74,00
○ Branco	232531	74,00
● Oxidado	232537	74,00



LED GX53 | 6,1W | 120°  
3000K | 490lm | CEE=G  
6 kWh/1000h



Art. N.º: 1005271 | 11,50 EUR

**GRAFIT**  
WL, Redondo, sensor, E27

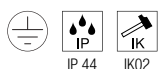
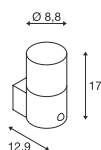

220-240V ~50/60Hz  
Material: alumínio/acrílico



Casquilho: 1xE27 máx. Ø: 6 cm | C: 11,5 cm

Versão	Art. n.º	EUR
● Antracite	<b>1006179</b>	<b>90,00</b>



LED E27 | 8W | 240°  
3000K | 880lm | CEE=E  
8 kWh/1000h



Art. N.º: **1005289** | **10,25 EUR**

**GRAFIT**  
WL, Redondo, E27

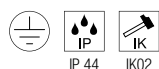
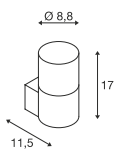

220-240V ~50/60Hz  
Material: alumínio/acrílico



Casquilho: 1xE27 máx. Ø: 6 cm | C: 11,5 cm

Versão	Art. n.º	EUR
● Antracite	<b>1006178</b>	<b>80,00</b>



A60 | 7,5W | 320°  
2700K | 800lm | CEE=F  
8 kWh/1000h



Art. N.º: **1005303** | **9,60 EUR**



1006178 880

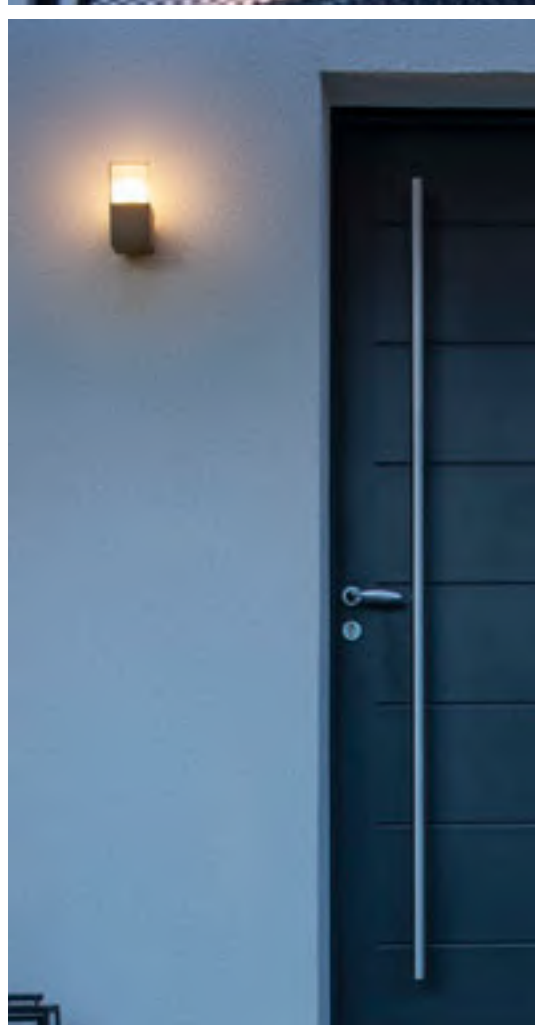





GRAFIT  
WL, Quadrado, sensor, E27

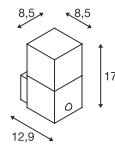

GRAFIT  
WL, E27

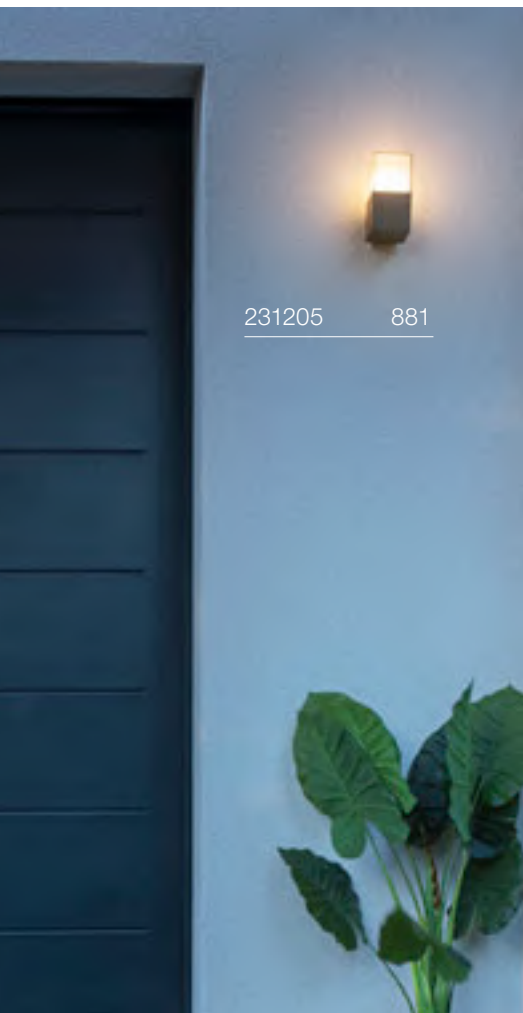
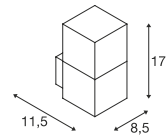

231205 881

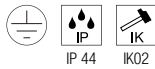

220-240V ~50/60Hz  
Material: alumínio/acrílico



Casquilho: 1xE27 máx. Ø: 6 cm C: 11,5 cm

Versão	Art. n.º	EUR
● Antracite	1006183	90,00



A60 | 7,5W | 320°  
2700K | 800lm | CEE=F  
8 kWh/1000h



Art. N.º: 1005303 | 9,60 EUR

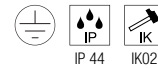

220-240V ~50/60Hz  
Material: alumínio/plástico



Casquilho: 1xE27 máx. Ø: 6 cm C: 11,5 cm

Versão	Art. n.º	EUR
● Antracite	231205	80,00



A60 | 7,5W | 320°  
2700K | 800lm | CEE=F  
8 kWh/1000h



Art. N.º: 1005303 | 9,60 EUR

## QUADRULO WL

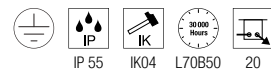
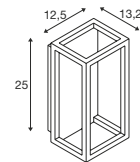

100-277V ~50/60Hz | 350mA  
Potência do sistema: 7,4W  
Material: alumínio/cloreto de polivinilo (PVC)



Down

270lm | 3000K

Versão	Art. n.º	EUR
● Antracite 270lm	1005201	164,00
●● Antracite/madeira 280lm	1007207	179,00

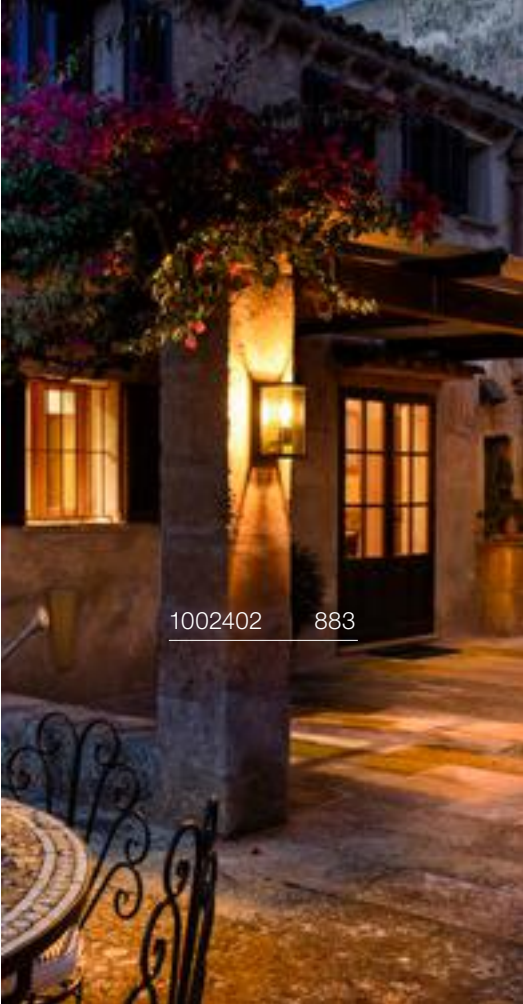

1002402 883

QUADRULO SENSOR  
WL, E27

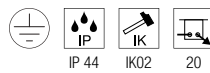
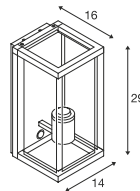

220-240V ~50/60Hz  
Material: alumínio/vidro

**SOCKET INSIDE** <15 W

Casquilho: 1xE27 máx. Ø: 8 cm | C: 18 cm

Versão	Art. n.º	EUR
● Antracite	1002402	169,00



LED E27 | 7,5W | 320°  
2500K | 700lm | CEE=F  
8 kWh/1000h

Art. N.º: 1005265 | 26,50 EUR



QUADRULO  
WL, E27

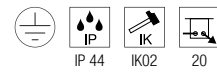
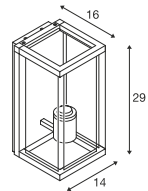

220-240V ~50/60Hz  
Material: alumínio/vidro

**SOCKET INSIDE** <15 W

Casquilho: 1xE27 máx. Ø: 8 cm | C: 18 cm

Versão	Art. n.º	EUR
● Antracite	1002403	149,00



LED E27 | 7,5W | 320°  
2500K | 700lm | CEE=F  
8 kWh/1000h

Art. N.º: 1005265 | 26,50 EUR



1002403 883

**MERIDIAN**  
WL, E27

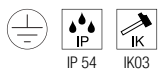
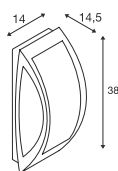

220-240V ~50/60Hz  
Material: alumínio/policarbonato (PC)



Casquilho: 1xE27 máx. Ø: 7 cm C: 17,5 cm

Versão	Art. n.º	EUR
● Antracite	230445	79,00
● Cinzento	230444	79,00



LED E27 | 8W | 240°  
3000K | 880lm | CEE=E  
8 kWh/1000h



Art. N.º: 1005289 | 10,25 EUR

**MERIDIAN BOX**  
WL, E27

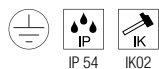
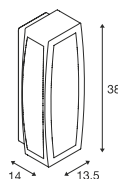

220-240V ~50/60Hz  
Material: alumínio/policarbonato (PC)



Casquilho: 1xE27 máx. Ø: 7 cm C: 17,5 cm

Versão	Art. n.º	EUR
● Antracite	230045	99,00
● Cinzento	230044	99,00



| 13,5W | 240°  
4000K | 1600lm | CEE=E  
14 kWh/1000h



Art. N.º: 1005308 | 12,50 EUR



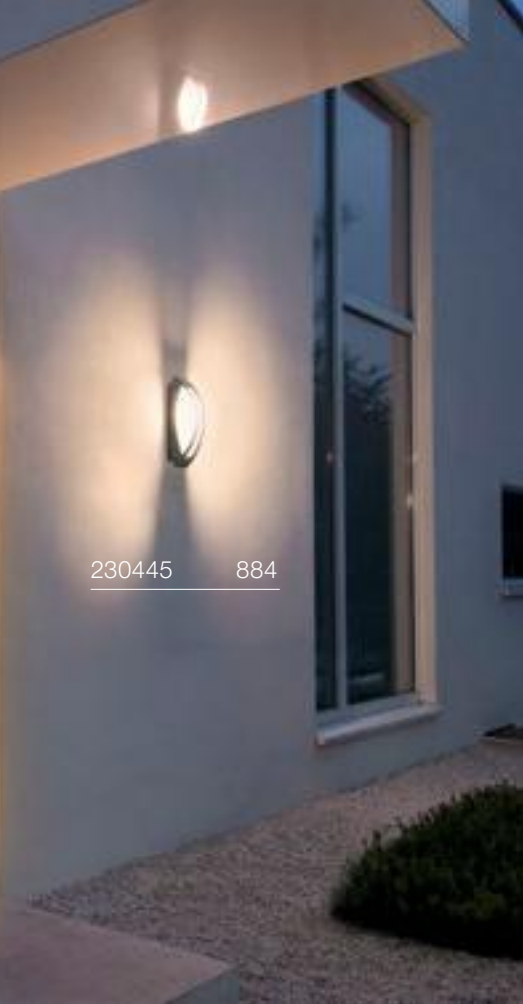

230445 884

### MERIDIAN BOX SENSOR WL, E27

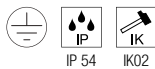
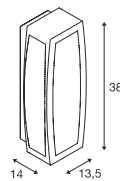

220-240V ~50/60Hz  
Material: alumínio/polycarbonato (PC)

- Pode ajustar-se a intensidade luminosa ambiente e o ciclo de funcionamento.



Casquilho: 1xE27 máx. Ø: 7 cm | C: 17,5 cm

Versão	Art. n.º	EUR
● Antracite	230085	164,00
● Cinzento	230084	164,00



LED E27 | 8W | 240°  
3000K | 880lm | CEE=E  
8 kWh/1000h



Art. N.º: 1005289 | 10,25 EUR

### MERIDIAN BOX WL, E27

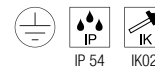
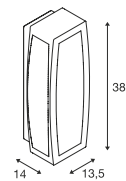

220-240V ~50/60Hz  
Material: alumínio/polycarbonato (PC)



Casquilho: 1xE27 máx. Ø: 7 cm | C: 17,5 cm

Versão	Art. n.º	EUR
● Antracite	230655	109,00
● Oxidado	230657	109,00



LED E27 | 7,5W | 320°  
2500K | 700lm | CEE=F  
8 kWh/1000h



Art. N.º: 1005265 | 26,50 EUR



230655 885

1004748 887



1006314 887

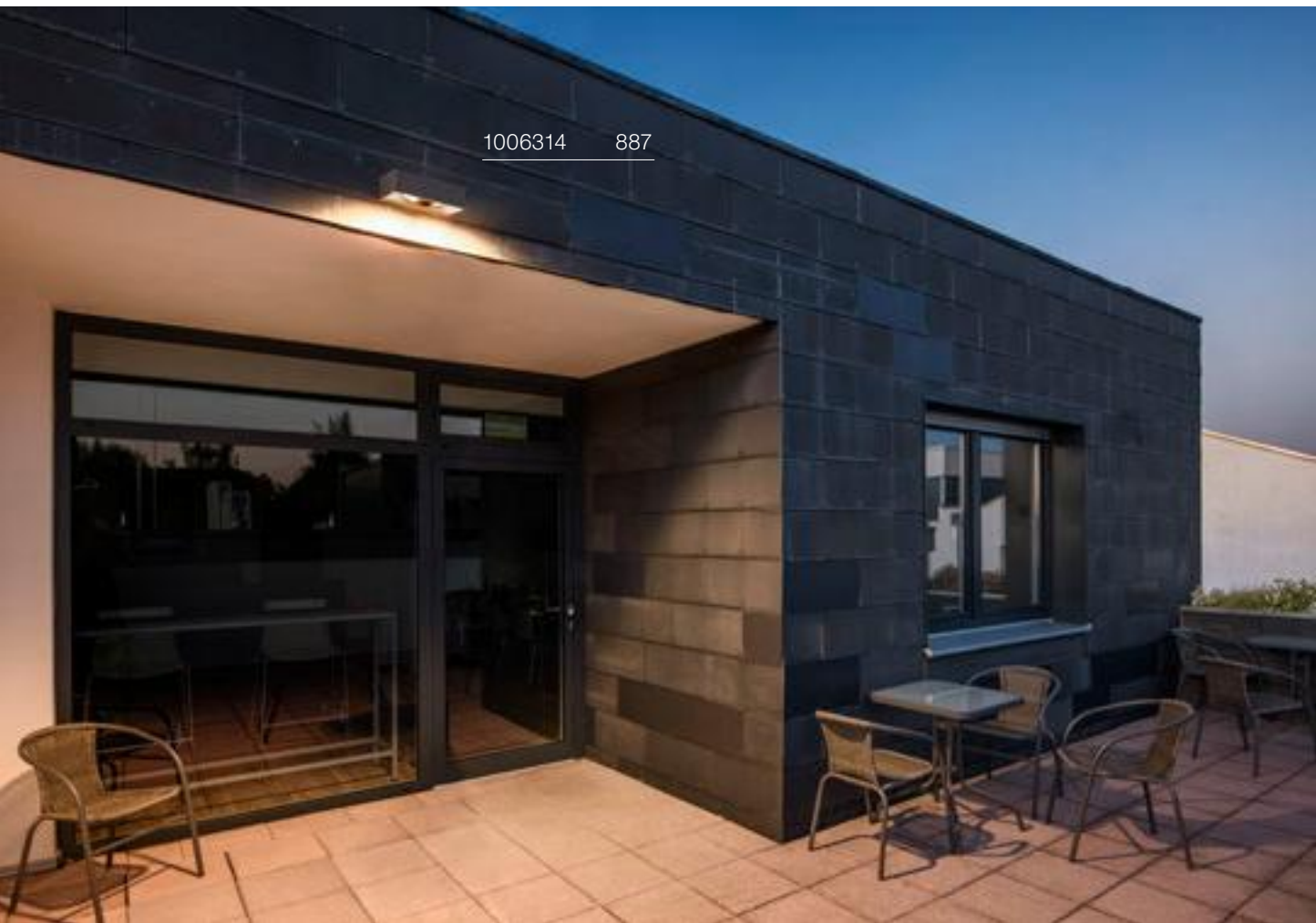

### ESKINA FRAME WL

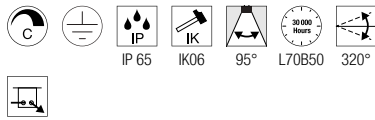
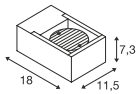

220-240V ~50/60Hz | 350mA  
Potência do sistema: 15W  
Material: alumínio



Down 1100lm | 3000K | 1200lm | 4000K

Versão	Art. n.º	EUR
● Antracite	1004747	222,00

### ESKINA FRAME WL, double

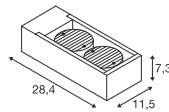
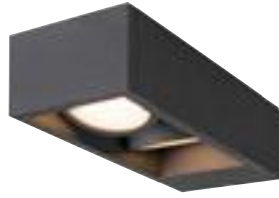

220-240V ~50/60Hz | 700mA  
Potência do sistema: 27W  
Material: alumínio



Spot 1 1100lm | 3000K | 1200lm | 4000K  
Spot 2 1100lm | 3000K | 1200lm | 4000K

Versão	Art. n.º	EUR
● Antracite	1004748	272,00

### ESKINA FRAME WL, double

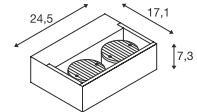

220-240V ~50/60Hz | 700mA  
Potência do sistema: 27W  
Material: alumínio



Spot 1 1100lm | 3000K | 1200lm | 4000K  
Spot 2 1100lm | 3000K | 1200lm | 4000K

Versão	Art. n.º	EUR
● Antracite	1006314	272,00

1005443 889





## BOOKAT WL

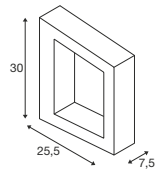
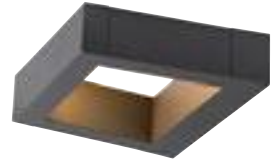

100-277V ~50/60Hz | 700mA  
Potência do sistema: 15W  
Material: alumínio



Down 920lm | 3000K | 990lm | 4000K

Versão	Art. n.º	EUR
● Antracite	1005443	201,00

# BIG QUAD WL

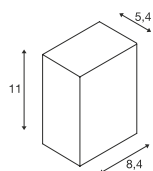

100-240V ~50/60Hz | 350mA  
Potência do sistema: 4,5W  
Material: alumínio/vidro



Down 260lm | 3000K

Versão	Art. n.º	EUR
● Antracite	232435	119,00
○ Branco	232431	119,00

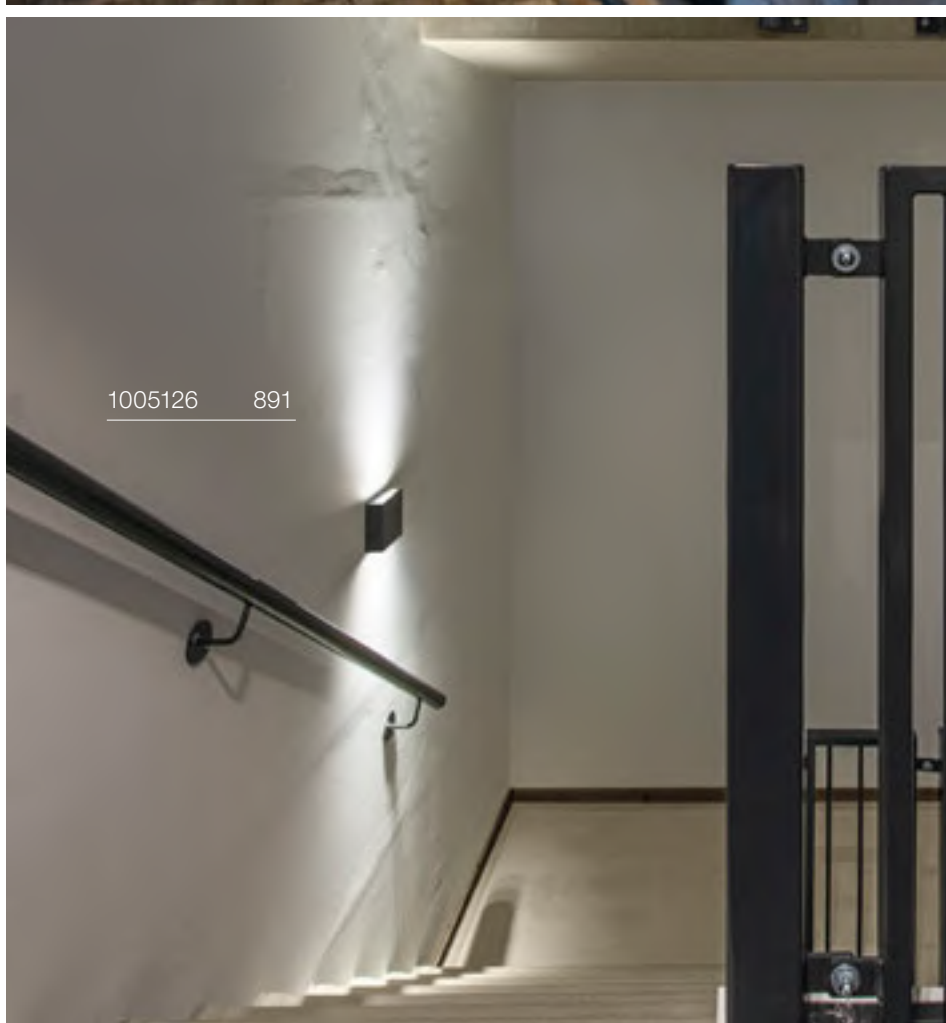

1005126 891

## BIG QUAD UP/DOWN WL



232435 890

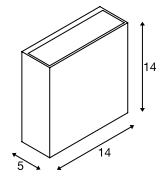

220-240V ~50/60Hz | 500mA  
 Potência do sistema: 8,2W  
 Material: alumínio/vidro



Up 320lm | 3000K  
 Down 320lm | 3000K

Versão	Art. n.º	EUR
● Antracite	<b>1005126</b>	<b>169,00</b>
○ Branco	<b>1005125</b>	<b>169,00</b>



# QUAD WL

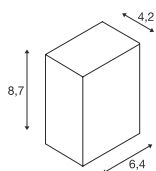

200-240V ~50/60Hz | 700mA  
Potência do sistema: 4,6W  
Material: alumínio/vidro



Down 80lm | 3000K  
100lm

Versão	Art. n.º	EUR
● Antracite	232465	84,00
○ Branco	232461	84,00

232445

893



## QUAD UP/DOWN 15 WL

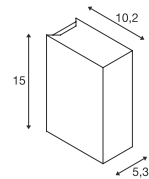

100-277V ~50/60Hz | 350mA  
Potência do sistema: 8W  
Material: alumínio/vidro



Up	260lm	3000K
Down	260lm	3000K

Versão	Art. n.º	EUR
● Antracite 520lm	<b>232445</b>	<b>129,00</b>
○ Branco 580lm	<b>232441</b>	<b>129,00</b>

RUSTY® UP/DOWN  
WL, Quadrado

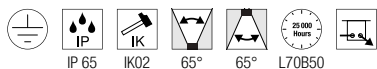
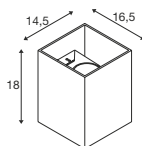

220-240V ~50/60Hz | 350mA  
Potência do sistema: 14W  
Material: aço FeCSi/alumínio



Up	259lm	3000K	260lm	4000K
Down	285lm		288lm	

Versão	Art. n.º	EUR
● Oxidado/antracite	1004650	279,00

RUSTY® UP/DOWN  
WL, Redondo

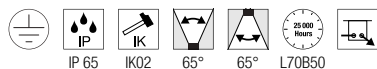
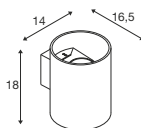

220-240V ~50/60Hz | 350mA  
Potência do sistema: 14W  
Material: aço FeCSi/alumínio



Up	249lm	3000K	254lm	4000K
Down	267lm		271lm	

Versão	Art. n.º	EUR
● Oxidado/antracite	1004651	279,00

1004650 894

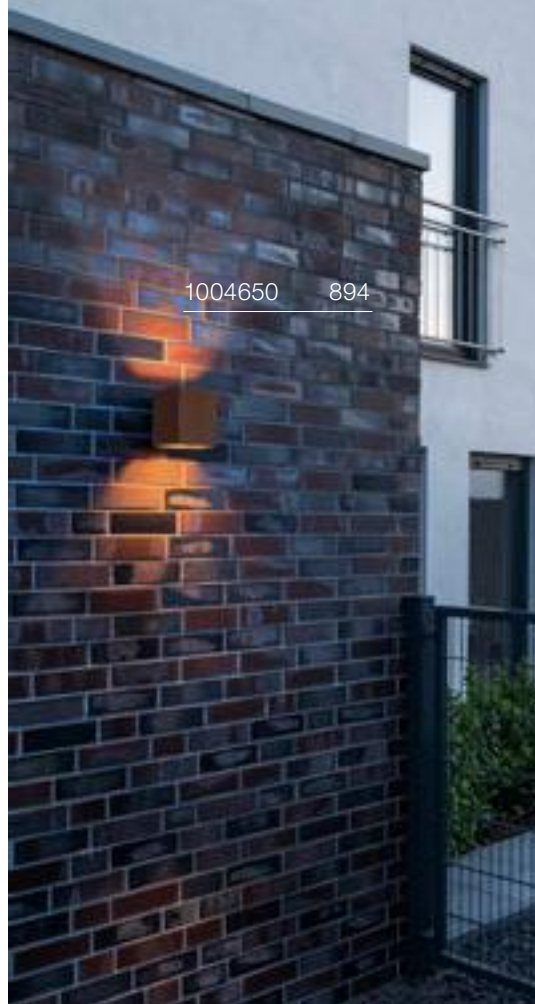



### OVALISK SENSOR WL

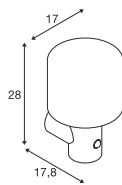

220-240V ~50/60Hz | 500mA  
Potência do sistema: 9,6W  
Material: alumínio/vidro



Down 580lm | 3000K | 630lm | 4000K

Versão	Art. n.º	EUR
● Antracite	1004679	289,00

### OVALISK WL

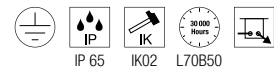
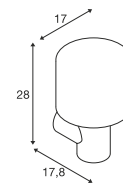

220-240V ~50/60Hz | 500mA  
Potência do sistema: 9,2W  
Material: alumínio/vidro



Down 580lm | 3000K | 630lm | 4000K

Versão	Art. n.º	EUR
● Antracite	1004678	269,00



1004679 895

PEMA®  
WL

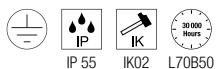
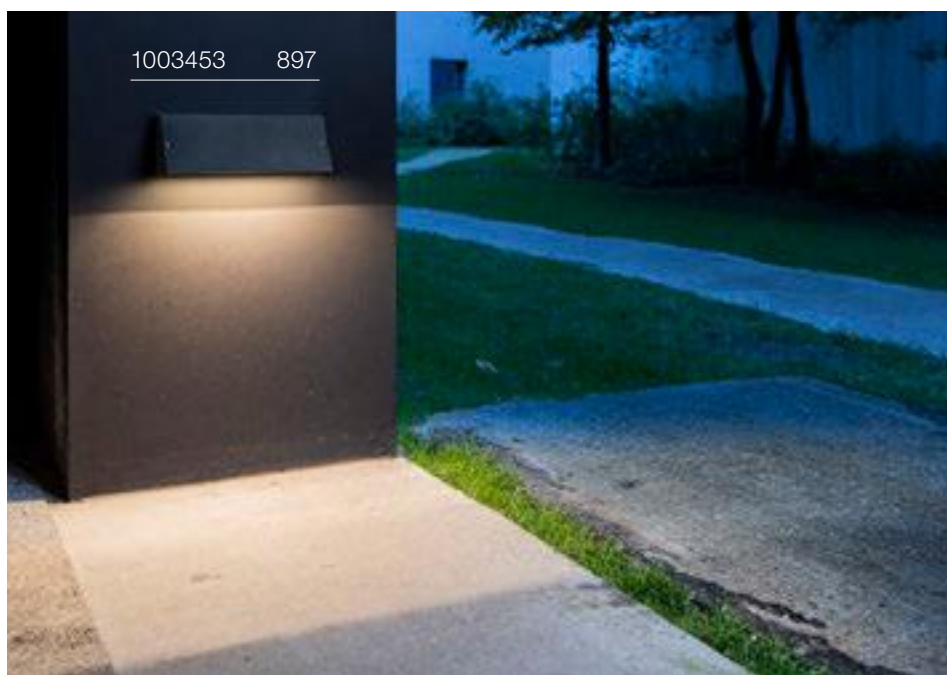
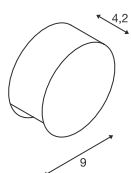

220-240V ~50/60Hz  
Potência do sistema: 3,8W  
Material: alumínio/policarbonato (PC)



Down 190lm | 3000K

Versão	Art. n.º	EUR
● Antracite	<b>231015</b>	<b>118,00</b>
○ Branco	<b>231010</b>	<b>118,00</b>
● Cinzento	<b>231012</b>	<b>118,00</b>





PEMA®  
WL

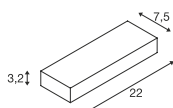
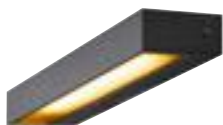

220-240V ~50/60Hz  
Potência do sistema: 7,7W  
Material: alumínio/vidro



Down 640lm | 3000K

Versão	Art. n.º	EUR
● Antracite	1002069	129,00
○ Branco	1002070	129,00

PEMA®  
WL

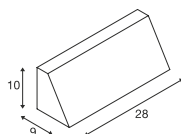

100-277V ~50/60Hz | 350mA  
Potência do sistema: 14W  
Material: alumínio/vidro



Down 1340lm | 3000K | 1420lm | 4000K

Versão	Art. n.º	EUR
● Preto	1003453	144,00
● Cinzento	1003454	144,00

PEMA®  
WL, E27

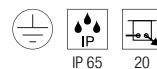
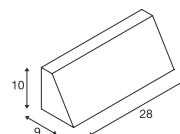

220-240V ~50/60Hz  
Material: alumínio/vidro



Casquilho: 1xE27 máx. Ø: 4,5 cm | C: 21 cm

Versão	Art. n.º	EUR
● Preto	230030	106,00
● Cinzento	230034	106,00



LED E27 | 8W | 240°  
3000K | 880lm | CEE=E  
8 kWh/1000h



Art. N.º: 1005289 | 10,25 EUR

# FLATT WL

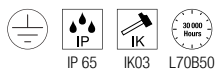
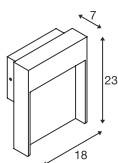

100-240V ~50/60Hz | 300mA  
Potência do sistema: 13W  
Material: alumínio/alumínio



Down	500lm	3000K	530lm	4000K
	500lm	3000K	550lm	4000K

Versão	Art. n.º	EUR
● Antracite 500/530lm	<b>1002952</b>	<b>171,00</b>
●● Antracite/castanho 500/550lm	<b>1002953</b>	<b>171,00</b>

# FLATT SENSOR WL

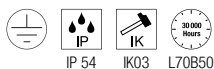
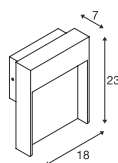

100-240V ~50/60Hz | 300mA  
Potência do sistema: 13W  
Material: alumínio/alumínio



Down	500lm	3000K	530lm	4000K
	500lm	3000K	550lm	4000K

Versão	Art. n.º	EUR
● Antracite 500/530lm	<b>1002954</b>	<b>211,00</b>
●● Antracite/castanho 500/550lm	<b>1002955</b>	<b>211,00</b>



1002955 896



ASTINA  
WL, QPAR51

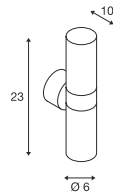

220-240V ~50/60Hz  
Material: alumínio/vidro

ASTINA STEEL  
WL, QPAR51

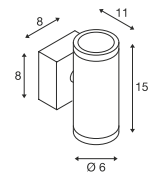

220-240V ~50/60Hz  
Material: aço inoxidável 304

228775 899



Casquilho: 2xGU10 máx. C: 9 cm

Versão	Art. n.º	EUR
● Antracite	228775	83,00
○ Branco	228771	83,00
● Alumínio	228776	88,00



LED QPAR51 | 2,4W | 36°  
2700K | 230lm | CEE=E  
3 kWh/1000h

Art. N.º: 1007230 | 5,50 EUR



Casquilho: 2xGU10 máx. Ø: 5,1 cm | C: 5,7 cm

Versão	Art. n.º	EUR
● Aço inoxidável	233302	124,00



LED QPAR51 | 2,4W | 36°  
3000K | 230lm | CEE=E  
3 kWh/1000h

Art. N.º: 1007231 | 5,50 EUR

1007809 901



# MODELA

WL, up/down

NEW

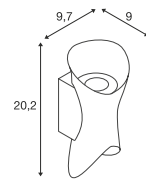

220-240V ~50Hz | 95mA  
 Potência do sistema: 7,5W  
 Material: alumínio



Up	385lm	2700K
	400lm	
405lm		
385lm		
400lm		
Down	405lm	

Versão	Art. n.º	EUR
● Preto 770lm	1007808	149,00
● Preto/dourado 810lm	1007807	149,00
○ Branco 800lm	1007809	149,00
○ Branco/dourado 810lm	1007806	149,00

## ANGOLUX SENSOR WL

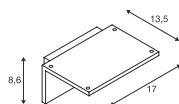

100-240V ~50/60Hz | 240mA  
Potência do sistema: 9,8W  
Material: alumínio

- Ângulo de detecção de 120°, distância máxima de detecção de 9 m, sensibilidade de resposta
- Índice de proteção IP44 apenas na montagem com emissão da luz para baixo



Down 750lm | 3000K

Versão	Art. n.º	EUR
● Antracite	1001969	181,00
○ Branco	1001970	181,00

## ANGOLUX WL

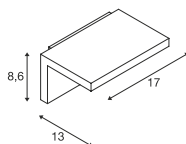

220-240V ~50/60Hz | 80mA  
Potência do sistema: 6,8W  
Material: alumínio

- Índice de proteção IP44 apenas na montagem com emissão da luz para baixo



Down 550lm | 3000K

Versão	Art. n.º	EUR
● Antracite	231355	161,00
○ Branco	231351	161,00

1001969 905

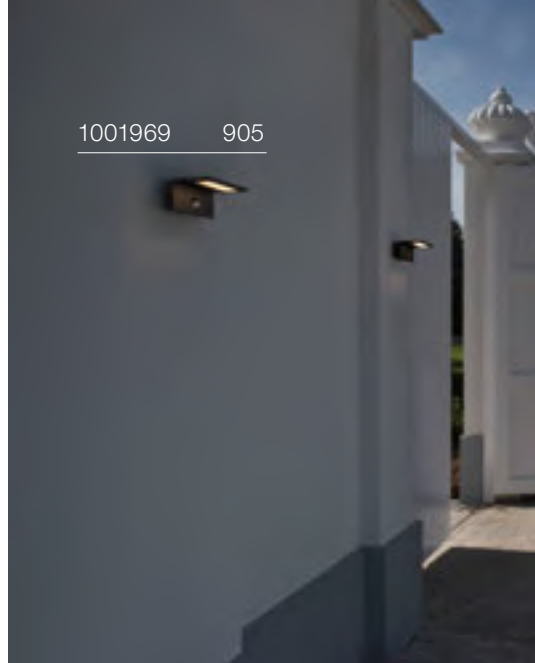

1002504 769033



1002505 903

VILUA S  
WL

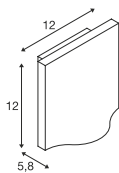

100-277V ~50/60Hz | 700mA  
Potência do sistema: 9W  
Material: alumínio/vidro



Down 405lm | 3000K

Versão	Art. n.º	EUR
● Antracite	1002503	159,00

VILUA L  
WL

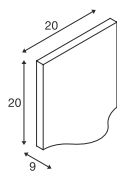

100-277V ~50/60Hz | 350mA  
Potência do sistema: 17W  
Material: alumínio/vidro



Down 940lm | 3000K

Versão	Art. n.º	EUR
● Antracite	1002504	199,00

VILUA  
UP/DOWN, WL

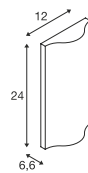

100-277V ~50/60Hz | 700mA  
Potência do sistema: 16W  
Material: alumínio/vidro



Up 400lm | 3000K  
Down 400lm | 3000K

Versão	Art. n.º	EUR
● Antracite	1002505	199,00

MYRA UP/DOWN  
WL, QPAR51

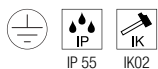
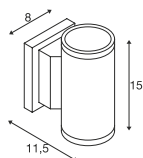

220-240V ~50/60Hz  
Material: alumínio/vidro



Casquilho: 2xGU10 máx. Ø: 5,1 cm C: 5,7 cm

Versão	Art. n.º	EUR
● Antracite	233115	99,00
● Cinzento	233114	99,00



LED GU10 51 mm | 6W | 36°  
2200-2700K | 360lm | CEE=G  
6 kWh/1000h



Art. N.º: 1005273 | 9,99 EUR



Artigo	Art. n.º	EUR
Montagem saliente da armação		
● Antracite	233215	21,75

233114 904





SITRA UP/DOWN  
WL

SITRA UP/DOWN  
WL, TCR-TSE



230362

905

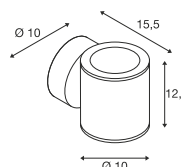
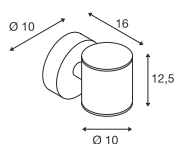

220-240V ~50/60Hz  
Potência do sistema: 18W  
Material: alumínio/vidro

220-240V ~50/60Hz  
Material: alumínio/vidro



Up 488lm | 3000K  
Down 488lm | 3000K

Casquilho: 2xGX53 máx. Ø: 7,5 cm | C: 3,5 cm

Versão	Art. n.º	EUR
● Antracite	1002018	149,00

Versão	Art. n.º	EUR
● Antracite	230365	99,00



LED GX53 | 6,1W | 120°  
3000K | 490lm | CEE=G  
6 kWh/1000h



Art. N.º: 1005271 | 11,50 EUR



1000334 907

ROX UP/DOWN  
WL, QPAR111

DELWA  
WL

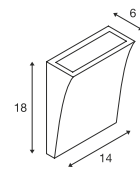
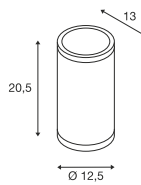

220-240V ~50/60Hz  
Material: alumínio/vidro



220-240V ~50/60Hz | 700mA  
Potência do sistema: 10W  
Material: alumínio/vidro



Casquilho: 2xGU10

Versão	Art. n.º	EUR
● Alumínio	1000334	191,00



Down 840lm | 3000K

Versão	Art. n.º	EUR
● Antracite	1000342	212,00
○ Branco	1000340	212,00



QPAR111 | 12,5W | 10°  
3000K | 950lm | CEE=F  
13 kWh/1000h



Art. N.º: 1005278 | 55,00 EUR

T-TUBE  
WL GU10 single, Sensor



A partir da primavera de 2025



T-TUBE  
WL GU10 double, Sensor



A partir da primavera de 2025



1008010 908



220-240V ~50/60Hz  
Material: alumínio



Casquilho: 1xGU10 máx. Ø: 5,1 cm | C: 5,5 cm

Versão	Art. n.º	EUR
● Preto	1008010	● 134,00



LED QPAR51 | 2,4W | 36°  
2700K | 230lm | CEE=E  
3 kWh/1000h

Art. N.º: 1007230 | 5,50 EUR



220-240V ~50/60Hz  
Material: alumínio



Casquilho: 2xGU10 máx. Ø: 5,1 cm | C: 5,5 cm

Versão	Art. n.º	EUR
● Preto	1008011	● 164,00



LED QPAR51 | 2,4W | 36°  
3000K | 230lm | CEE=E  
3 kWh/1000h

Art. N.º: 1007231 | 5,50 EUR



T-TUBE  
WL GU10 single

A  
partir da  
primavera  
de 2025



T-TUBE  
WL GU10 double

A  
partir da  
primavera  
de 2025



220-240V ~50/60Hz  
Material: alumínio

**SOCKET INSIDE** 10 W

Casquilho: 1xGU10 máx. Ø: 5,1 cm | C: 5,5 cm

Versão	Art. n.º	EUR
● Preto	1008012	● 109,00



LED QPAR51 | 6W | 38°  
2700K | 450lm | CEE=F  
6 kWh/1000h



Art. N.º: 1005077 | 7,50 EUR



220-240V ~50/60Hz  
Material: alumínio

**SOCKET INSIDE** 10 W

Casquilho: 2xGU10 máx. Ø: 5,1 cm | C: 5,5 cm

Versão	Art. n.º	EUR
● Preto	1008013	● 149,00



LED QPAR51 | 2,4W | 36°  
2700K | 230lm | CEE=E  
3 kWh/1000h



Art. N.º: 1007230 | 5,50 EUR

WALLYX  
WL, QPAR51

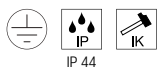
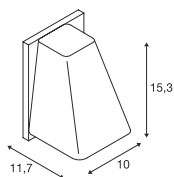

220-240V ~50/60Hz  
Material: alumínio/vidro

**SOCKET**  
**INSIDE** <50  
W

Casquilho: 1xGU10 máx. C: 7,6 cm

Versão	Art. n.º	EUR
● Antracite	227195	119,00



LED GU10 51 mm | 6W | 36°  
2200-2700K | 360lm | CEE=G  
6 kWh/1000h



Art. N.º: 1005273 | 9,99 EUR



227195 910



1002868 911



### DOWNUNDER OUT WL, Redondo

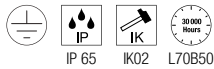
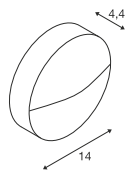

100-240V ~50/60Hz | 500mA  
Potência do sistema: 4,3W  
Material: alumínio



Down 150lm | 3000K | 160lm | 4000K

Versão	Art. n.º	EUR
● Antracite	1002868	134,00

### DOWNUNDER OUT WL, Quadrado

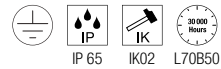
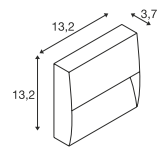

100-240V ~50/60Hz | 500mA  
Potência do sistema: 4,3W  
Material: alumínio



Down 150lm | 3000K | 160lm | 4000K

Versão	Art. n.º	EUR
● Antracite	1002869	134,00

1008542 913





## ABRIDOR WL, HYBRID

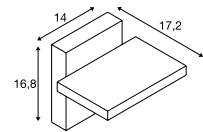

100-240V ~50/60Hz |  
 Funcionamento a bateria de 380mA  
 Potência do sistema: 6,8W  
 Material: alumínio

- Possibilidade de funcionamento solar e com 230V
- 3 modos diferentes
- Carregamento da bateria através de energia solar



Down 600lm | 2200K | 650lm | 2700K

Versão	Art. n.º	EUR
● Antracite	1008542	● 199,00

1002990 915



### ABRIDOR WL

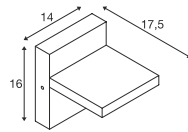

100-240V ~50/60Hz | 300mA  
Potência do sistema: 12W  
Material: alumínio



Down 950lm | 3000K | 980lm | 4000K

Versão	Art. n.º	EUR
● Antracite	1002989	181,00

### ABRIDOR SENSOR WL

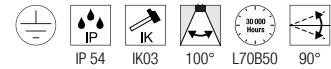
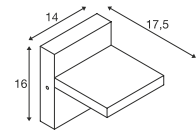

100-240V ~50/60Hz | 300mA  
Potência do sistema: 12W  
Material: alumínio



Down 950lm | 3000K | 980lm | 4000K

Versão	Art. n.º	EUR
● Antracite	1002990	201,00

## ORDI II SENSOR WL



A partir da primavera de 2025



## ORDI II WL

A partir da primavera de 2025

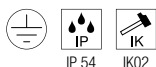

220-240V ~50/60Hz  
Potência do sistema: 10W  
Material: alumínio

- Funcionalidade primária e de réplica, podem ser ligadas várias luminárias



Down 700lm | 2200K | 700lm | 3000K

Versão	Art. n.º	EUR
● Preto	1008723	209,00
○ Branco	1008724	209,00

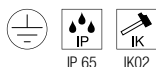

220-240V ~50/60Hz  
Potência do sistema: 10W  
Material: alumínio



Down 700lm | 2200K | 700lm | 3000K

Versão	Art. n.º	EUR
● Preto	1008721	189,00
○ Branco	1008722	189,00



1008723 916



ORDI SENSOR  
WL

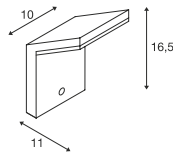

220-240V ~50/60Hz | 110mA  
Potência do sistema: 9W  
Material: alumínio



Down 740lm | 3000K

Versão	Art. n.º	EUR
● Antracite	232915	149,00

ORDI  
WL

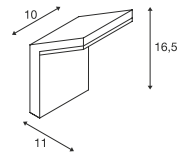

220-240V ~50/60Hz | 110mA  
Potência do sistema: 9W  
Material: alumínio



Down 740lm | 3000K

Versão	Art. n.º	EUR
● Antracite	232905	129,00

232905 917

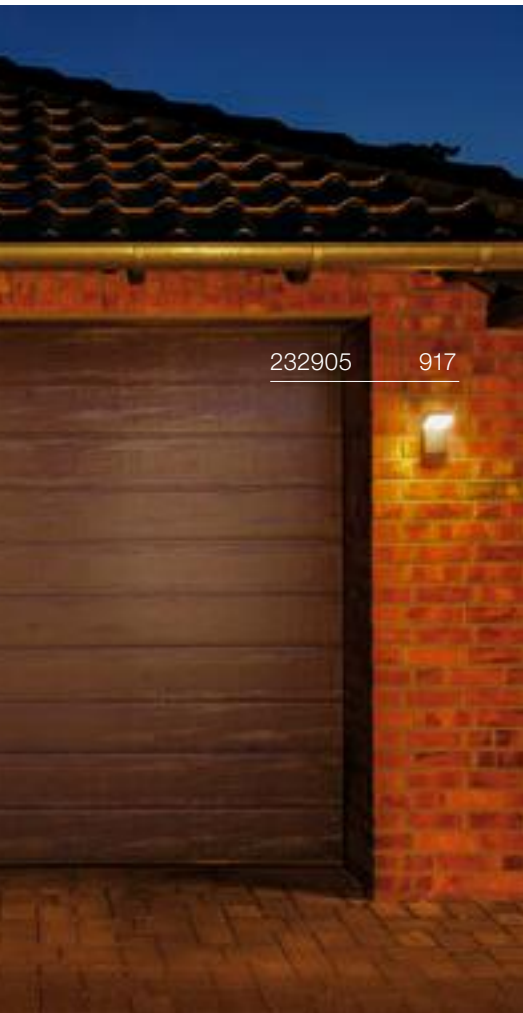



232495 919



1002035 919

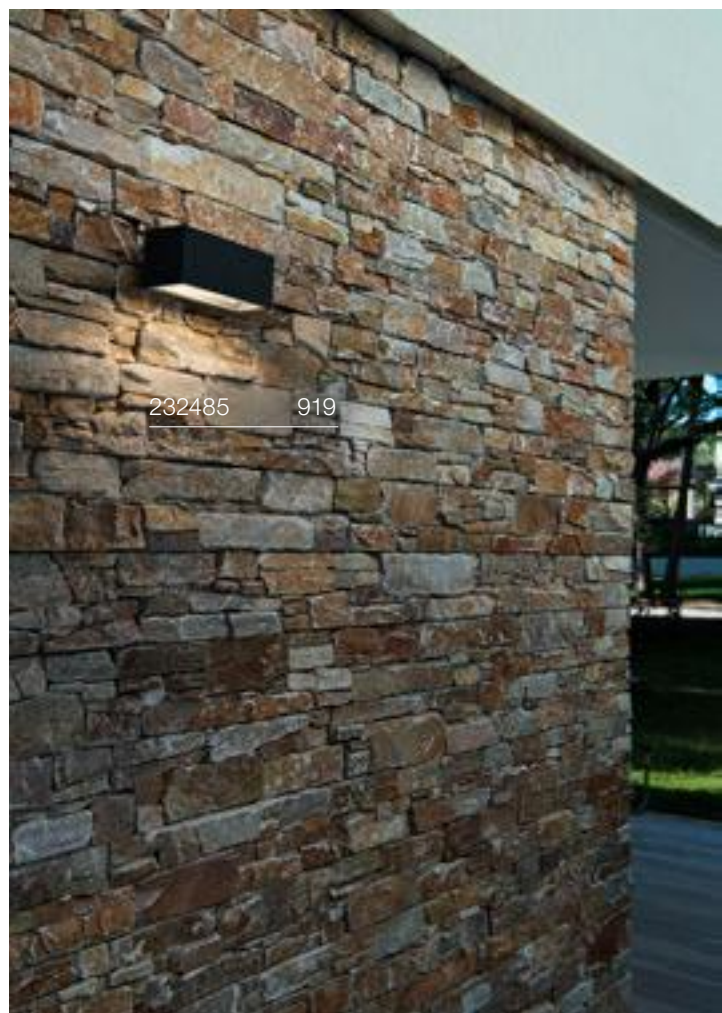

232485 919

**BOX-L**  
WL, E27

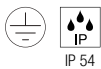
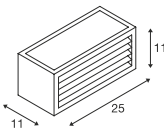

220-240V ~50/60Hz  
Material: alumínio/acrílico



Casquilho: 1xE27 máx. Ø: 6 cm | C: 17,5 cm

Versão	Art. n.º	EUR
● Antracite	232495	104,00
○ Branco	232491	104,00
● Oxidado	232497	104,00



LED E27 | 8W | 240°  
3000K | 880lm | CEE=E  
8 kWh/1000h



Art. N.º: 1005289 | 10,25 EUR

**BOX-L**  
WL

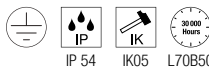
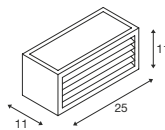

100-277V ~50/60Hz | 500mA  
Potência do sistema: 19W  
Material: alumínio/acrílico



Down 600lm | 3000K

Versão	Art. n.º	EUR
● Antracite	1002035	128,00

**BOX UP/DOWN**  
WL, QT-DE12

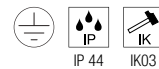
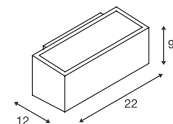

220-240V ~50/60Hz  
Material: alumínio



Casquilho: 1xR7s 78 mm

Versão	Art. n.º	EUR
● Antracite	232485	100,00



LED R7s | 9W | 330°  
3000K | 1050lm | CEE=E  
9 kWh/1000h



Art. N.º: 1005287 | 24,00 EUR



232101

921



1003539

921



LOGS  
WL

OUT-BEAM UP/  
FLOOD DOWN  
WL

L-LINE OUT  
WL

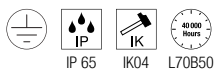
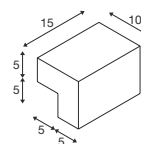
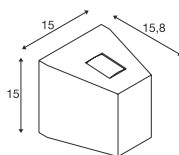
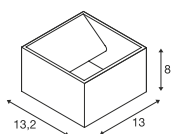

220-240V ~50/60Hz | 500mA  
Potência do sistema: 9,5W  
Material: alumínio



220-240V ~50/60Hz | 500mA  
Potência do sistema: 18W  
Material: alumínio/vidro

- O efeito de luz de 2° é particularmente adequado para definir o contorno e a estrutura de superfícies e fachadas de edifícios.



220-240V ~50/60Hz | 350mA  
Potência do sistema: 7W  
Material: alumínio/policarbonato (PC)



Down 520lm | 3000K

Versão	Art. n.º	EUR
● Antracite 520lm	232105	200,00
○ Branco 800lm	232101	200,00



Up  
Down 50lm | 3000K  
690lm | 3000K

Versão	Art. n.º	EUR
● Antracite	229665	274,00
● Cinzento	229664	274,00



Down 500lm | 3000K | 570lm | 4000K

Versão	Art. n.º	EUR
● Antracite	1003539	141,00

232045 923



PHOTONIA  
WL, E27

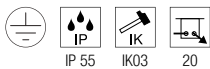
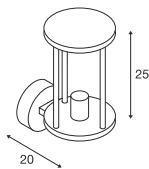

220-240V ~50/60Hz  
Material: alumínio/vidro

**SOCKET INSIDE** <60 W

Casquilho: 1xE27 máx. Ø: 9 cm | C: 15 cm

Versão	Art. n.º	EUR
● Antracite	232045	189,00

LED E27 | 7,5W | 320°  
2500K | 700lm | CEE=F  
8 kWh/1000h

Art. N.º: 1005265 | 26,50 EUR

⊕

Artigo	Art. n.º	EUR
Espaçador		
● Antracite	1002853	7,75

MOLAT  
WL, E27

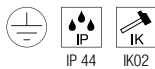
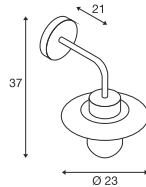

220-240V ~50/60Hz  
Material: alumínio/vidro

**SOCKET INSIDE** 60 W

Casquilho: 1xE27 máx. Ø: 6,5 cm | C: 14,5 cm

Versão	Art. n.º	EUR
● Antracite	1000820	99,00

A60 | 7,5W | 320°  
2700K | 800lm | CEE=F  
8 kWh/1000h

Art. N.º: 1005303 | 9,60 EUR

GLOO PURE  
WL, E27

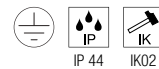
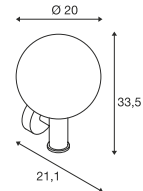

220-240V ~50/60Hz  
Material: alumínio/vidro

**SOCKET INSIDE** <23 W

Casquilho: 1xE27 máx. Ø: 4,8 cm | C: 18 cm

Versão	Art. n.º	EUR
● Antracite	1002002	97,00

LED E27 | 8W | 240°  
4000K | 920lm | CEE=E  
8 kWh/1000h

Art. N.º: 1005290 | 10,25 EUR



1000336 925

F-POL  
WL, E27

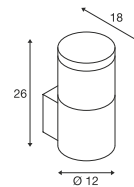

230355 925

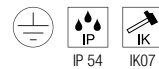

220-240V ~50/60Hz  
Material: alumínio/policarbonato (PC)

**SOCKET**  
**INSIDE**

<20  
W

Casquilho: 1xE27 máx. Ø: 5,1 cm | C: 14 cm

Versão	Art. n.º	EUR
● Antracite	231585	141,00



LED E27 | 8W | 240°  
4000K | 920lm | CEE=E  
8 kWh/1000h



Art. N.º: 1005290 | 10,25 EUR

SQUARE  
WL, E27

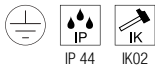
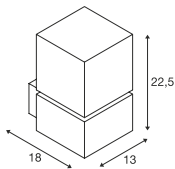

220-240V ~50/60Hz  
Material: aço inoxidável 304



Casquilho: 1xE27 máx. Ø: 7 cm | C: 13 cm

Versão	Art. n.º	EUR
● Aço inoxidável	1000336	224,00

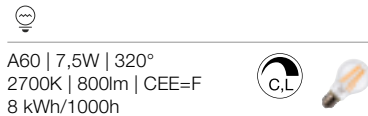

A60 | 7,5W | 320°  
2700K | 800lm | CEE=F  
8 kWh/1000h

Art. N.º: 1005303 | 9,60 EUR

KERAS ELT  
WL, E27

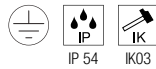
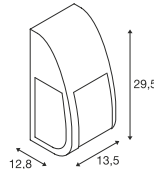

220-240V ~50/60Hz  
Material: alumínio/policarbonato (PC)



Casquilho: 1xE27 máx. Ø: 7 cm | C: 17,5 cm

Versão	Art. n.º	EUR
● Antracite	227176	162,00

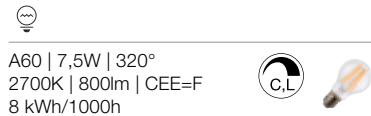

A60 | 7,5W | 320°  
2700K | 800lm | CEE=F  
8 kWh/1000h

Art. N.º: 1005303 | 9,60 EUR

SITRA  
WL, TCR-TSE

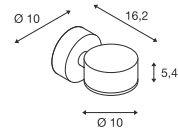

220-240V ~50/60Hz  
Material: alumínio/vidro



Casquilho: 1xGX53 máx. Ø: 7,5 cm | C: 3,5 cm

Versão	Art. n.º	EUR
● Antracite	230355	69,00

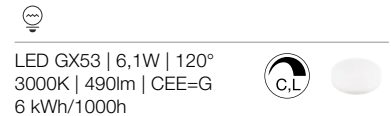

LED GX53 | 6,1W | 120°  
3000K | 490lm | CEE=G  
6 kWh/1000h

Art. N.º: 1005271 | 11,50 EUR

# IPERI WL

231315

926

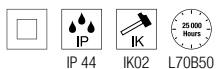
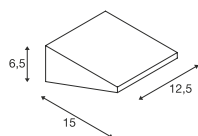

220-240V ~50/60Hz  
Potência do sistema: 4,5W  
Material: alumínio

- Índice de proteção IP44 apenas na montagem com emissão da luz para baixo.



Down 400lm | 4000K

Versão	Art. n.º	EUR
● Preto	231315	129,00

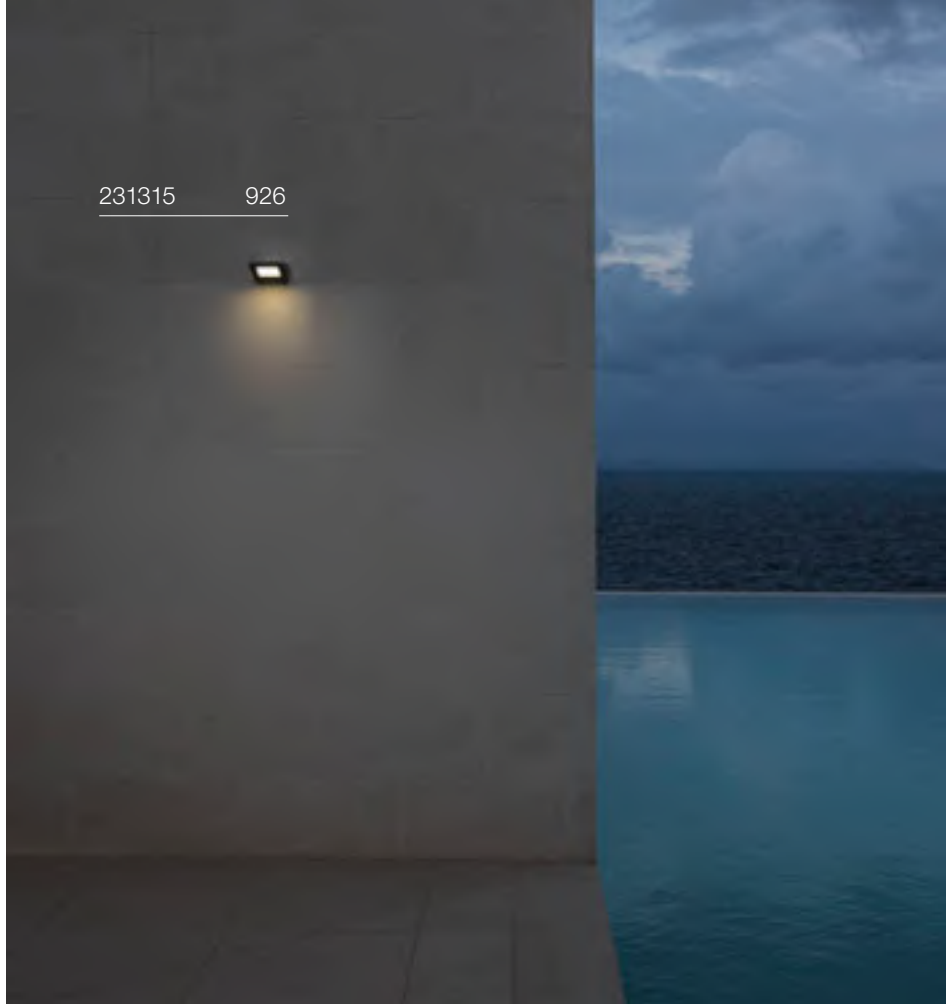

232285

927

EXTERIOR | LUMINÁRIAS SALIENTES DE PAREDE E TETO



## QUADRASYL WL, TCR-TSE

## SQUARE TURN WL, G9

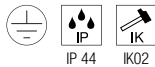
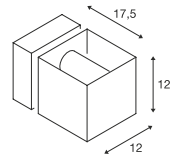
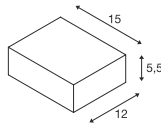
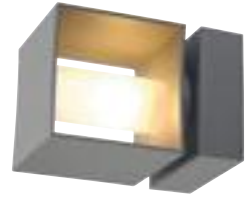

IP 44 IK02

220-240V ~50/60Hz  
Material: alumínio/vidro



IP 44

220-240V ~50/60Hz  
Material: alumínio/vidro

1000335

927



Casquilho: 1xGX53 máx. Ø: 7,5 cm | C: 2,7 cm

Versão	Art. n.º	EUR
● Antracite	232285	64,00



LED GX53 | 6,1W | 120°  
3000K | 490lm | CEE=G  
6 kWh/1000h



Art. N.º: 1005271 | 11,50 EUR



Casquilho: 1xG9 máx. Ø: 3,5 cm | C: 8 cm

Versão	Art. n.º	EUR
● Cinzento	1000335	209,00



LED G9 | 3,6W | 300°  
3000K | 400lm | CEE=E  
4 kWh/1000h



Art. N.º: 1005286 | 8,80 EUR

1002905 929



233134 929





### TODAY PRO Display

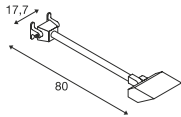

220-240V ~50/60Hz | 640mA  
Potência do sistema: 29W  
Material: alumínio



Down 2800lm | 4000K

Versão	Art. n.º	EUR
● Preto	1000880	228,00
○ Branco	1000881	228,00

### ESKINA D Display, PHASE

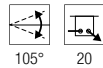
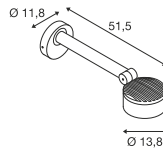

220-240V ~50/60Hz | 350mA  
Potência do sistema: 14,5W  
Material: alumínio

- Interruptor CCT na cabeça da luminária



Down 1000lm | 3000K | 1000lm | 4000K

Versão	Art. n.º	EUR
● Antracite	1002905	272,00

### MYRA DISPLAY WL, curved, QPAR51

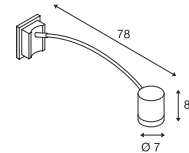

220-240V ~50/60Hz  
Material: alumínio



Casquilho: 1xGU10 máx. Ø: 5,1 cm | C: 5,7 cm

Versão	Art. n.º	EUR
● Antracite	233135	179,00
● Cinzento	233134	179,00



LED GU10 51 mm | 6W | 36°  
2200-2700K | 360lm | CEE=G  
6 kWh/1000h



Art. N.º: 1005273 | 9,99 EUR



Artigo	Art. n.º	EUR
Montagem saliente da armação		
● Antracite	233215	21,75



1004649 931



233104 931

### LED SPOT SP

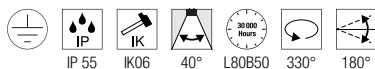
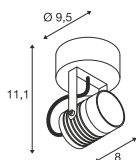

100-240V ~50/60Hz | 240mA  
Potência do sistema: 6W  
Material: alumínio/vidro



Down 400lm | 3000K

Versão	Art. n.º	EUR
● Antracite	1004649	72,00
● Oxidado	1004957	72,00

Artigo	Art. n.º	EUR
NAUTILUS   Placa de montagem		
● Preto	1002884	5,40

### NAUTILUS WL QPAR51

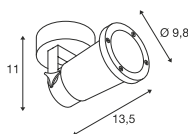

220-240V ~50/60Hz  
Material: alumínio



Casquilho: 1xGU10 máx. Ø: 5,1 cm | C: 8,3 cm

Versão	Art. n.º	EUR
● Preto	1002867	49,00



LED QPAR51 | 2,4W | 36°  
3000K | 230lm | CEE=E  
3 kWh/1000h

Art. N.º: 1007231 | 5,50 EUR

Artigo	Art. n.º	EUR
NAUTILUS   Placa de montagem		
● Preto	1002884	5,40

### MYRA CW, single, QPAR51

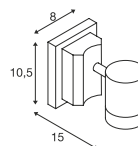

220-240V ~50/60Hz  
Material: alumínio/vidro



Casquilho: 1xGU10 máx. Ø: 5,1 cm | C: 5,7 cm

Versão	Art. n.º	EUR
● Antracite	233105	89,00
● Cinzento	233104	89,00



LED QPAR51 | 2,4W | 36°  
2700K | 230lm | CEE=E  
3 kWh/1000h

Art. N.º: 1007230 | 5,50 EUR

Artigo	Art. n.º	EUR
Montagem saliente da armação		
● Cinzento	233214	21,75

1008384 933



## RASTERLYS WL



A  
partir da  
primavera  
de 2025



220-240V ~50/60Hz | 350mA  
Potência do sistema: 14W  
Material: alumínio



Down 350lm | 2700K | 400lm | 3000K

Versão	Art. n.º	EUR
● Antracite	1008384	● 179,00

1007653 935



## S-TUBE CW

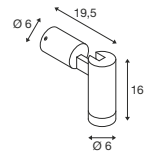

220-240V ~50/60Hz  
Material: alumínio

**SOCKET INSIDE** <10 W

Casquilho: 1xGU10 máx. Ø: 5,1 cm | C: 5,5 cm

Versão	Art. n.º	EUR
● Preto	1007653	99,00



LED GU10 51 mm | 6W | 36°  
2200-2700K | 360lm | CEE=G  
6 kWh/1000h



Art. N.º: 1005273 | 9,99 EUR

1002904 937





### ESKINA SPOT SENSOR CW, PHASE

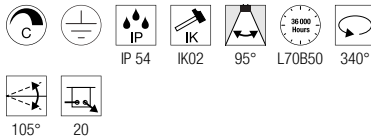
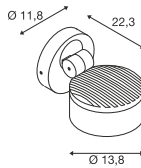

220-240V ~50/60Hz | 350mA  
Potência do sistema: 15W  
Material: alumínio

- Detetor de movimento na roseta de parede



Down 1000lm | 3000K | 1000lm | 4000K

Versão	Art. n.º	EUR
● Antracite	1002904	272,00

### ESKINA SPOT CW, PHASE

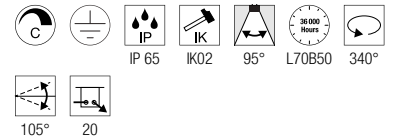
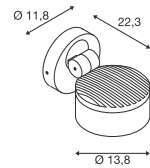

220-240V ~50/60Hz | 350mA  
Potência do sistema: 14,5W  
Material: alumínio



Down 1000lm | 3000K | 1000lm | 4000K

Versão	Art. n.º	EUR
● Antracite	1002903	252,00

SITRA 360  
CW, TCR-TSE

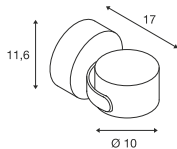

220-240V ~50/60Hz  
Material: alumínio/vidro



Casquilho: 1xGX53 máx. Ø: 7,5 cm | C: 3,5 cm

Versão	Art. n.º	EUR
● Antracite	231515	109,00



LED GX53 | 6,1W | 120°  
3000K | 490lm | CEE=G  
6 kWh/1000h



Art. N.º: 1005271 | 11,50 EUR

THEO BRACKET  
CW

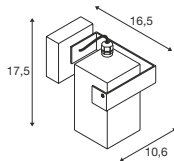

220-240V ~50/60Hz  
Material: alumínio/vidro



Casquilho: 1xGU10 máx. Ø: 5,1 cm | C: 5,7 cm

Versão	Art. n.º	EUR
● Antracite	1004653	74,00



LED GU10 51 mm | 6W | 36°  
2200-2700K | 360lm | CEE=G  
6 kWh/1000h



Art. N.º: 1005273 | 9,99 EUR



233245

939

1004653 938

HELIA  
CW, single

HELIA  
CW, double

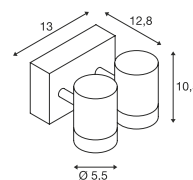
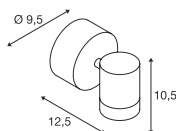

220-240V ~50/60Hz | 500mA  
Potência do sistema: 6,5W  
Material: alumínio/vidro

220-240V ~50/60Hz | 500mA  
Potência do sistema: 13W  
Material: alumínio/vidro



Down 440lm | 3000K

Spot 1 440lm | 3000K  
Spot 2 440lm | 3000K

Versão	Art. n.º	EUR
● Antracite	233245	176,00

Versão	Art. n.º	EUR
● Antracite	233255	309,00

⊕

Artigo	Art. n.º	EUR
Espaçador		
● Antracite	1002853	7,75

⊕

Artigo	Art. n.º	EUR
Espaçador		
● Antracite	1002853	7,75



1003518 941

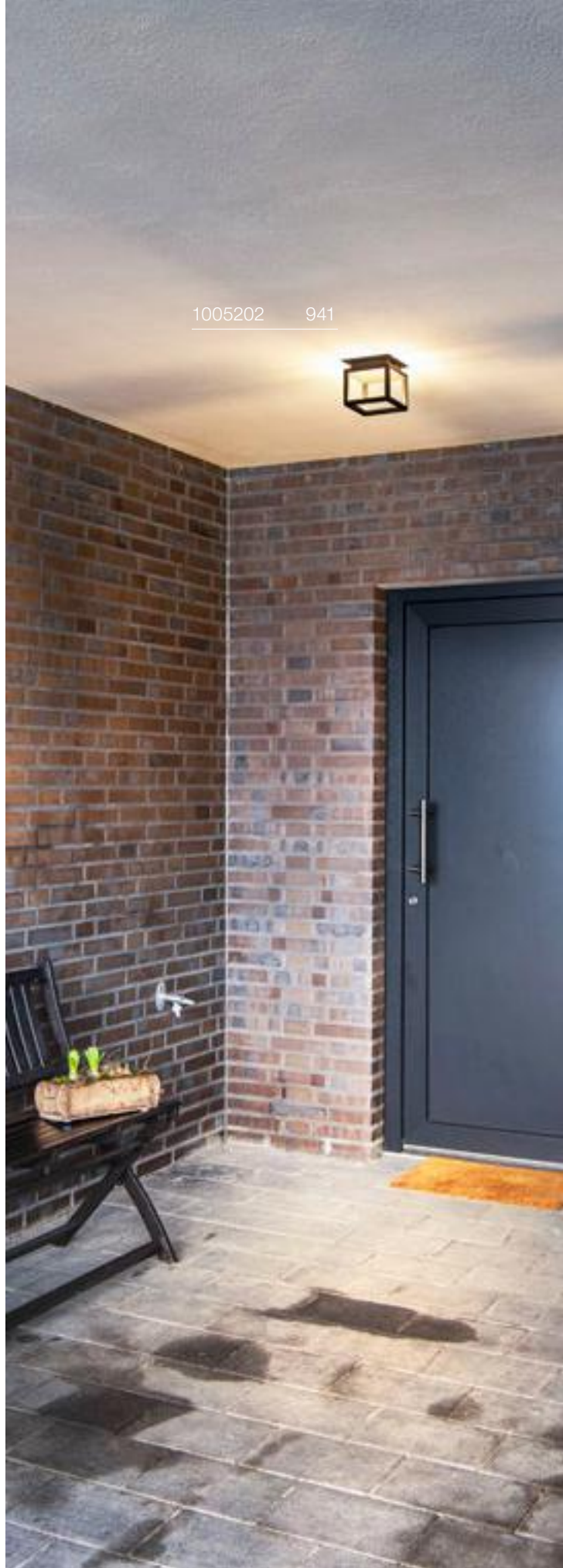

1005202 941

**MYRA**  
WL, double, QPAR51

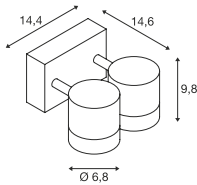

220-240V ~50/60Hz  
Material: alumínio/vidro



Casquilho: 2xGU10 máx. Ø: 5,1 cm | C: 5,7 cm

Versão	Art. n.º	EUR
● Antracite	233095	169,00
● Cinzento	233094	169,00



LED GU10 51 mm | 6W | 38°  
2700K | 450lm | CEE=F  
6 kWh/1000h

Art. N.º: 1005077 | 7,50 EUR



Artigo	Art. n.º	EUR
Espaçador		
● Antracite	1002853	7,75

**OUT-BEAM FRAME**  
SP

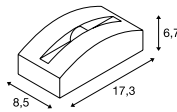

100-240V ~50/60Hz | 700mA  
Potência do sistema: 3,5W  
Material: alumínio/acrílico



Down 60lm | 3000K

Versão	Art. n.º	EUR
● Antracite	1003518	119,00
○ Branco	1003519	119,00

**QUADRULO**  
CL

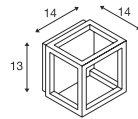
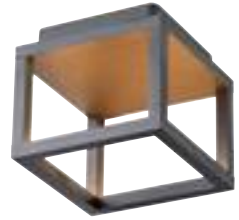

100-277V ~50/60Hz | 480mA  
Potência do sistema: 7,5W  
Material: alumínio/acrílico



Down 230lm | 3000K

Versão	Art. n.º	EUR
● Antracite	1005202	164,00



229971 943

## AINOS CW

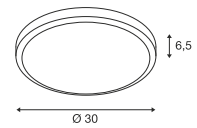

220-240V ~50/60Hz | 500mA  
Potência do sistema: 21W  
Material: alumínio/policarbonato (PC)



Down

1430lm | 3000K

Versão	Art. n.º	EUR
● Antracite	229965	149,00
○ Branco	229961	149,00



1003452 943

### AINOS CW SENSOR

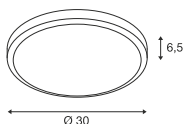

220-240V ~50/60Hz | 500mA  
Potência do sistema: 22W  
Material: alumínio/policarbonato (PC)

- Sensor no corpo da luminária.



Down 1430lm | 3000K

Versão	Art. n.º	EUR
● Antracite	229975	195,00
○ Branco	229971	195,00

### AINOS CW, Quadrado

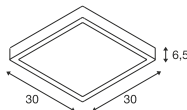

220-240V ~50/60Hz | 500mA  
Potência do sistema: 17W  
Material: alumínio/policarbonato (PC)



Down 1300lm | 3000K | 1300lm | 4000K

Versão	Art. n.º	EUR
● Antracite	1003450	161,00
○ Branco	1003449	161,00

### AINOS CW SENSOR, Quadrado

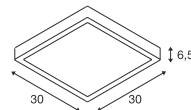

220-240V ~50/60Hz | 500mA  
Potência do sistema: 18W  
Material: alumínio/policarbonato (PC)

- Sensor no corpo da luminária.



Down 1300lm | 3000K | 1300lm | 4000K

Versão	Art. n.º	EUR
● Antracite	1003452	201,00
○ Branco	1003451	201,00

RUBA  
CW

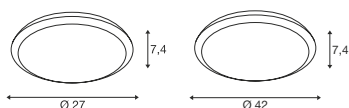

220-240V ~50/60Hz | 600mA  
Potência do sistema: 22W  
Material: policarbonato (PC)



Down 960lm | 3000K | 1100lm | 4000K  
2000lm

Versão	Art. n.º	EUR
○ Branco   Ø: 27cm 960/1100lm   12W	<b>1005089</b>	<b>109,00</b>
○ Branco   Ø: 42cm 2000/2300lm   22W	<b>1005090</b>	<b>219,00</b>

TERANG 200  
CW

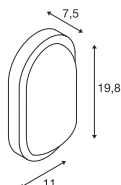

220-240V ~50/60Hz  
Potência do sistema: 11W  
Material: alumínio/policarbonato (PC)



Down 830lm | 3000K

Versão	Art. n.º	EUR
● Antracite	<b>229935</b>	<b>79,00</b>
○ Branco	<b>229931</b>	<b>79,00</b>

229071

944

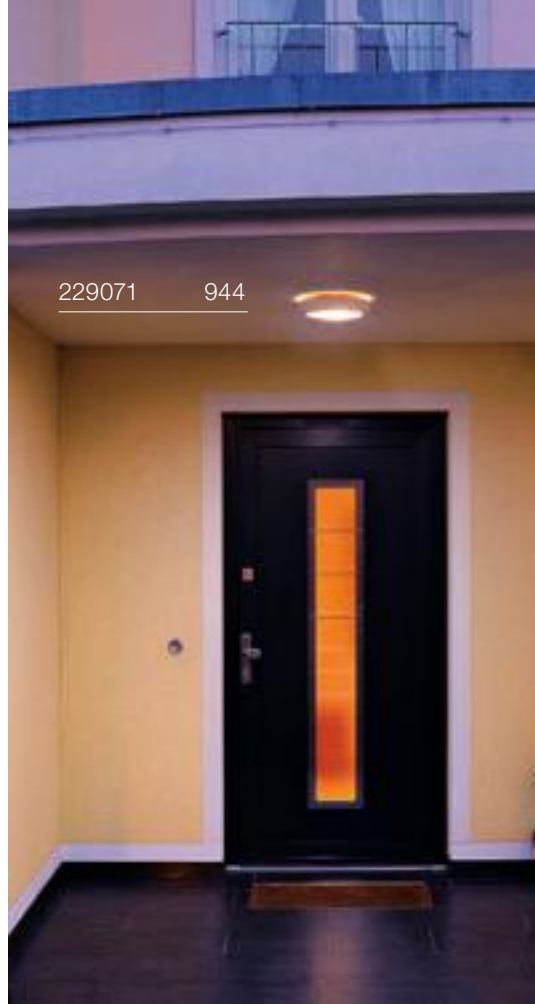





**BULAN**  
CW, E14

**BULAN GRID**  
CW, E27

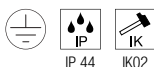
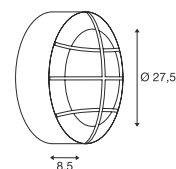
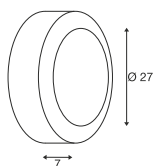

220-240V ~50/60Hz  
Material: alumínio/vidro

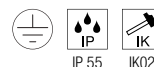

220-240V ~50/60Hz  
Material: alumínio/policarbonato (PC)

229085 945



Casquilho: 1xE14 máx. Ø: 4,8 cm | C: 13 cm



Casquilho: 2xE27 máx. Ø: 5,2 cm | C: 17,3 cm

Versão	Art. n.º	EUR
● Antracite	229075	66,00
○ Branco	229071	66,00
● Cinzento	229072	66,00

Versão	Art. n.º	EUR
● Antracite	229085	70,00
○ Branco	229081	70,00



C35 | 4,2W | 320°  
2700K | 350lm | CEE=G  
5 kWh/1000h



Art. N.º: 1005285 | 8,50 EUR



| 13,5W | 240°  
4000K | 1600lm | CEE=E  
14 kWh/1000h



Art. N.º: 1005308 | 12,50 EUR



233605

951



LED

CONCRETO | 949



LED

CONCRETO | 949



LED

ADI | 950



LED

DOWNUNDER  
OUT S | 951



LED

DOWNUNDER  
OUT M | 951



LED

DOWNUNDER  
OUT L | 951



LED

BRICK MESH | 953



LED

BRICK | 953



LED

BRICK | 953



SOCKET

BRICK  
DOWNUNDER | 955



LED

BRICK  
DOWNUNDER | 955



1006406 949

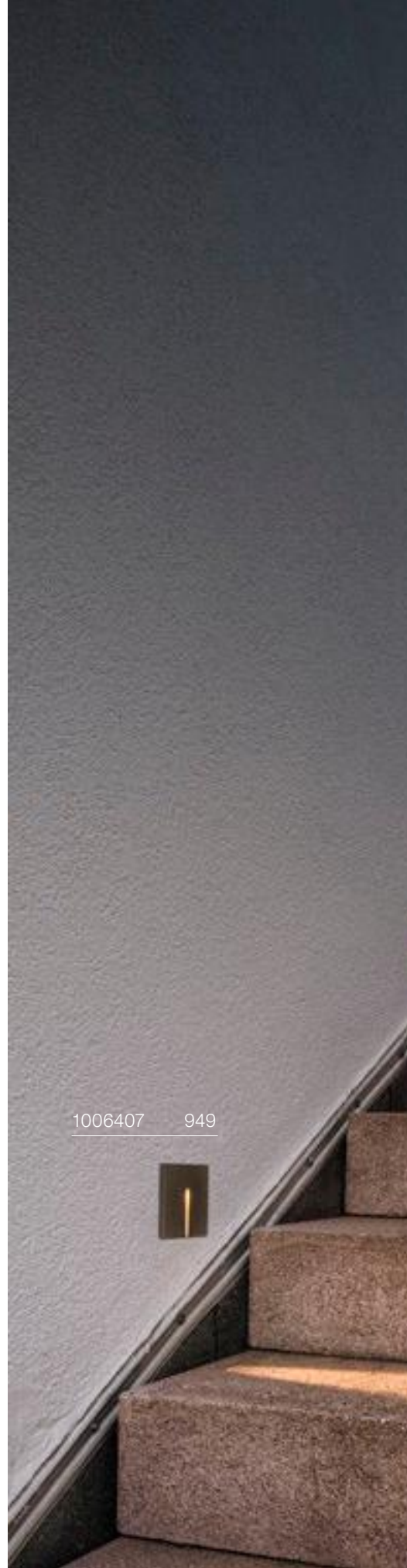

1006407 949



### CONCRETO EL, Wing

### CONCRETO EL, Cut

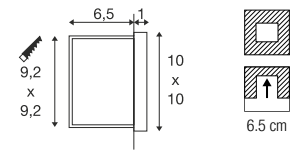
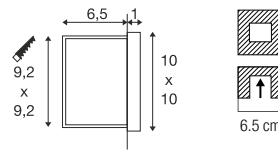

100-240V ~50/60Hz | 700mA  
Potência do sistema: 3,2W  
Material: betão/alumínio

100-240V ~50/60Hz | 700mA  
Potência do sistema: 3,2W  
Material: betão/alumínio

- Caixa de encastramento incluída

- Caixa de encastramento incluída



Down 45lm | 3000K

Down 15lm | 3000K

Versão	Art. n.º	EUR
● Cinzento	1006406	98,00

Versão	Art. n.º	EUR
● Cinzento	1006407	98,00

ADI  
EL

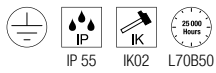
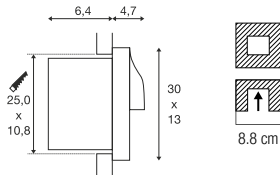

100-277V ~50/60Hz | 500mA  
Potência do sistema: 18W  
Material: alumínio/policarbonato (PC)

- Montar a luminária com a emissão de luz a apontar apenas para baixo.
- A Caixa de encastramento tem de ser encomendada à parte



Down 940lm | 3000K

Versão	Art. n.º	EUR
● Antracite	233635	262,00

Artigo	Art. n.º	EUR
⊕ Caixa de encastramento		
● Preto	233639	19,70



233625 951



233615 951



## DOWNUNDER OUT S EL

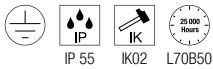
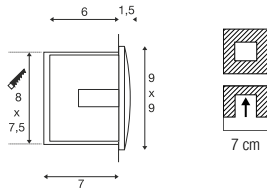

220-240V ~50/60Hz | 300mA  
Potência do sistema: 1,7W  
Material: alumínio/plástico

- Montar a luminária com a emissão de luz a apontar apenas para baixo.
- Caixa de encastramento incluída



Down 25lm | 3000K  
65lm

Versão	Art. n.º	EUR
● Antracite		
25lm	<b>233605</b>	<b>63,00</b>
○ Branco		
65lm	<b>233601</b>	<b>63,00</b>

## DOWNUNDER OUT M EL

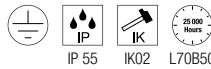
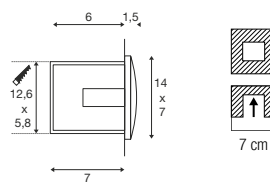

220-240V ~50/60Hz | 300mA  
Potência do sistema: 4W  
Material: alumínio/plástico

- Montar a luminária com a emissão de luz a apontar apenas para baixo.
- Caixa de encastramento incluída



Down 85lm | 3000K  
155lm

Versão	Art. n.º	EUR
● Antracite		
85lm	<b>233625</b>	<b>75,00</b>
○ Branco		
155lm	<b>233621</b>	<b>75,00</b>

## DOWNUNDER OUT L EL

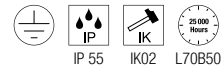
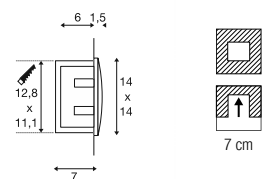

220-240V ~50/60Hz | 300mA  
Potência do sistema: 4W  
Material: alumínio/plástico

- Montar a luminária com a emissão de luz a apontar apenas para baixo.
- Caixa de encastramento incluída



Down 85lm | 3000K

Versão	Art. n.º	EUR
● Antracite	<b>233615</b>	<b>89,00</b>



233650 953



233660 953





## BRICK MESH EL

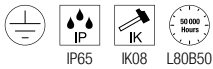
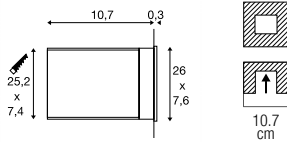
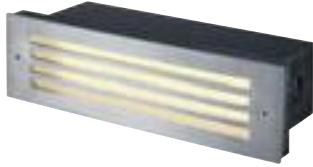

220-240V ~50/60Hz | 500mA  
Potência do sistema: 5W  
Material: alumínio

- Caixa de encastramento incluída



Down 150lm | 3000K

Versão	Art. n.º	EUR
● Aço inoxidável	1008481	243,00

## BRICK EL, Simétrico

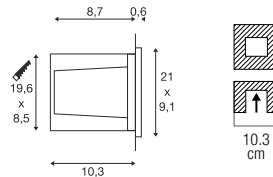

220-240V ~50/60Hz | 144mA  
Potência do sistema: 9,5W  
Material: alumínio/aço inoxidável 316

- Caixa de encastramento incluída



Down 950lm | 3000K

Versão	Art. n.º	EUR
● Aço inoxidável	233650	303,00

## BRICK EL, Assimétrico

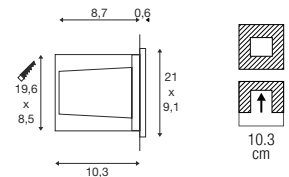

220-240V ~50/60Hz | 144mA  
Potência do sistema: 9,5W  
Material: alumínio/aço inoxidável 316

- Caixa de encastramento incluída



Down 850lm | 3000K

Versão	Art. n.º	EUR
● Aço inoxidável	233660	303,00



229062 955



## BRICK DOWNUNDER EL, E14

## BRICK DOWNUNDER EL

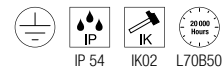
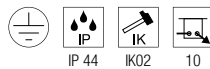
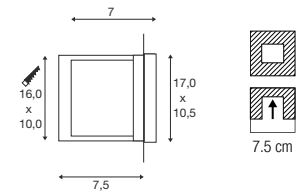
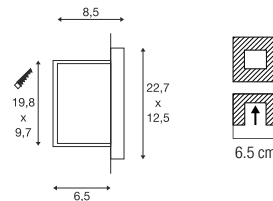

220-240V ~50/60Hz  
Material: alumínio/vidro

220-240V ~50/60Hz  
Potência do sistema: 1,4W  
Material: alumínio/vidro

• Não é necessário Caixa de encastramento

• Caixa de encastramento incluída



Casquilho: 1xE14 máx. Ø: 4,3 cm | C: 12 cm

Down 30lm | 3000K

Versão	Art. n.º	EUR
● Cinzento	229062	41,50

Versão	Art. n.º	EUR
● Cinzento	229702	67,00



C35 | 4,2W | 320°  
2700K | 350lm | CEE=G  
5 kWh/1000h



Art. N.º: 1005285 | 8,50 EUR



1006106 969



					
LED DASAR® 600   959	LED DASAR® 1200   959	LED DASAR® S   961	LED DASAR® S   961	LED DASAR® M   962	LED DASAR® M   963
					
LED DASAR® L   965	LED DASAR® L   965	LED DASAR® XL   966	LED DASAR® XL   967	LED DASAR® FLAT 80   969	LED DASAR® FLAT 120   969
					
LED DASAR® 255   969	LED DASAR® 920   970	LED DASAR® 920   970	LED DASAR® 270   971	LED DASAR® 270   971	SOCKET DASAR® 115   973
					
SOCKET DASAR® 115   973	SOCKET DASAR® 115   973	SOCKET DASAR® EXACT 116   975	SOCKET DASAR® EXACT 116   975	SOCKET DASAR® 215   976	SOCKET DASAR® 215   977
					
SOCKET DASAR® 215   977	LED DASAR® 370   977	LED TRAIL-LITE® 60   978	LED POWER TRAIL-LITE®   979	LED POWER TRAIL-LITE®   979	LED SMALL PLOT   981
					
LED SMALL PLOT   981	LED SMALL PLOT   983	LED BIG PLOT   983	LED ROCCI   984	LED ROCCI   984	LED ROCCI 200   985
					
LED ROCCI 200   985	SOCKET SOLASTO   987	SOCKET SOLASTO   987			



1007196 959



## DASAR® 600 EL

## DASAR® 1200 EL

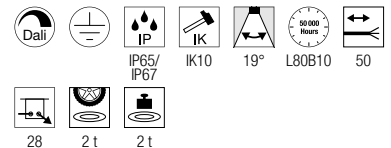
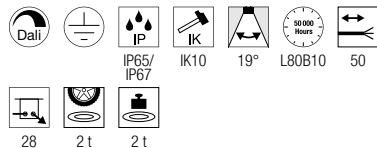
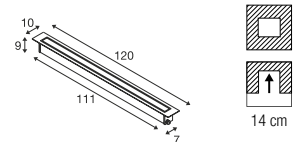
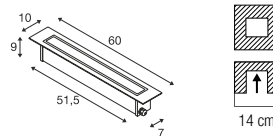

220-240V ~50/60Hz | 550mA  
Potência do sistema: 18W  
Material: aço inoxidável 316

220-240V ~50/60Hz | 900mA  
Potência do sistema: 34W  
Material: aço inoxidável 316

- Direção de instalação marcada
- A Caixa de encastramento, incluindo a tampa, pode ser encomendada separadamente
- Caixa de ligação IP

- Direção de instalação marcada
- A Caixa de encastramento, incluindo a tampa, pode ser encomendada separadamente
- Caixa de ligação IP



Down 2200lm | 3000K

Down 4100lm | 3000K

Versão	Art. n.º	EUR
● Aço inoxidável	1007195	549,00

Versão	Art. n.º	EUR
● Aço inoxidável	1007196	729,00

⊕

Artigo	Art. n.º	EUR
Caixa de encastramento		
● Preto	1007198	29,00

⊕

Artigo	Art. n.º	EUR
Caixa de encastramento		
● Preto	1007197	49,00



1007680

961





### DASAR® S RL, Redondo

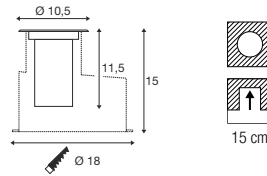

220-240V ~50/60Hz | 200mA  
Potência do sistema: 4W  
Material: alumínio

- Distribuição da luz convenientemente ajustável utilizando óticas intercambiáveis de 15°. 36° e 50°
- A Caixa de encastramento, incluindo a tampa, pode ser encomendada separadamente
- Caixa de ligação IP



Down 350lm | 3000K

Versão	Art. n.º	EUR
● Aço inoxidável	1007680	209,00



Artigo	Art. n.º	EUR
Caixa de encastramento no pavimento S		
● Preto	1007682	49,00
○ Prateado	1007683	6,00
Refletor 36°		
○ Prateado	1007684	6,00
Refletor 50°		
○ Prateado	1007685	6,00

### DASAR® S RL, Quadrado

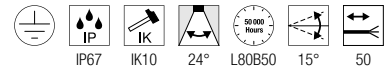
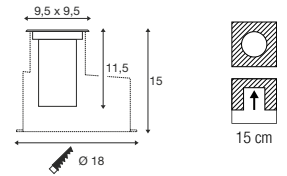

220-240V ~50/60Hz | 200mA  
Potência do sistema: 4W  
Material: alumínio

- Distribuição da luz convenientemente ajustável utilizando óticas intercambiáveis de 15°. 36° e 50°
- A Caixa de encastramento, incluindo a tampa, pode ser encomendada separadamente
- Caixa de ligação IP



Down 350lm | 3000K

Versão	Art. n.º	EUR
● Aço inoxidável	1007681	209,00



Artigo	Art. n.º	EUR
Caixa de encastramento no pavimento S		
● Preto	1007682	49,00
○ Prateado	1007683	6,00
Refletor 36°		
○ Prateado	1007684	6,00
Refletor 50°		
○ Prateado	1007685	6,00

# DASAR® M RL, Redondo

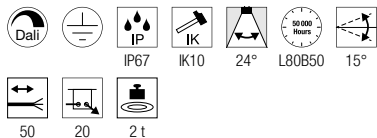
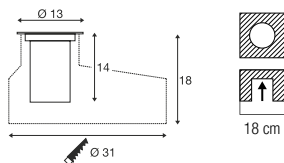

220-240V ~50/60Hz | 300mA  
Potência do sistema: 6,5W  
Material: alumínio

- Distribuição da luz convenientemente ajustável utilizando óticas intercambiáveis de 15°. 36° e 50°
- A Caixa de encastramento, incluindo a tampa, pode ser encomendada separadamente



Down 450lm | 3000K

Versão	Art. n.º	EUR
● Aço inoxidável	1007810	● 349,00

Artigo	Art. n.º	EUR
Caixa de encastramento no pavimento M		
● Preto	1007822	● 79,00
Refletor 15°		
○ Prateado	1007683	6,00
Refletor 36°		
○ Prateado	1007684	6,00
Refletor 50°		
○ Prateado	1007685	6,00



1007810 962



## DASAR® M RL, Quadrado

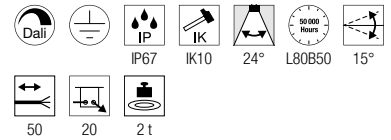
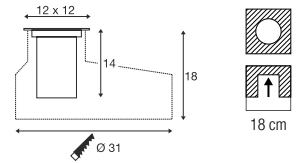

220-240V ~50/60Hz | 300mA  
Potência do sistema: 6,5W  
Material: alumínio

- Distribuição da luz convenientemente ajustável utilizando óticas intercambiáveis de 15°, 36° e 50°
- A Caixa de encastramento, incluindo a tampa, pode ser encomendada separadamente



Down

450lm | 3000K

Versão	Art. n.º	EUR
● Aço inoxidável	1007811	● 349,00



Artigo	Art. n.º	EUR
Caixa de encastramento no pavimento M		
● Preto	1007822	● 79,00
Refletor 15°		
○ Prateado	1007683	6,00
Refletor 36°		
○ Prateado	1007684	6,00
Refletor 50°		
○ Prateado	1007685	6,00



1007243 965



1007244 965



### DASAR® L RL, Redondo

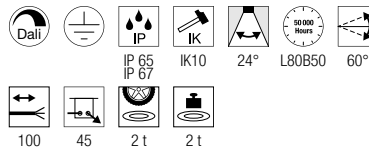
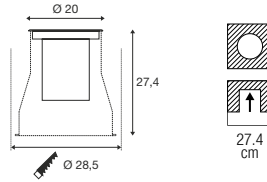

220-240V ~50/60Hz | 500mA  
Potência do sistema: 19W  
Material: alumínio

- Distribuição da luz convenientemente ajustável utilizando óticas intercambiáveis de 15°, 36° e 60°
- A Caixa de encastramento, incluindo a tampa, pode ser encomendada separadamente
- Caixa de ligação Y-IP68



Down 1950lm | 3000K

Versão	Art. n.º	EUR
● Aço inoxidável	1007243	479,00



Artigo	Art. n.º	EUR
Caixa de encastramento para DASAR® L		
● Preto	1007245	49,00
○ Refletor de 15° para DASAR® L / XL		
○ Prateado	1007238	12,00
○ Refletor de 36° para DASAR® L / XL		
○ Prateado	1007239	12,00
○ Refletor de 60° para DASAR® L / XL		
○ Prateado	1007240	12,00

### DASAR® L RL, Quadrado

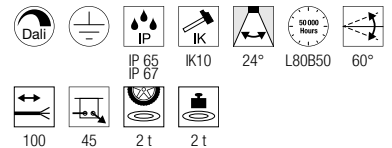
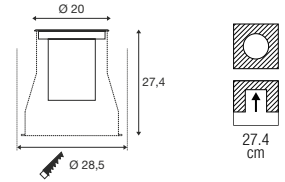

220-240V ~50/60Hz | 500mA  
Potência do sistema: 19W  
Material: alumínio

- Distribuição da luz convenientemente ajustável utilizando óticas intercambiáveis de 15°, 36° e 60°
- A Caixa de encastramento, incluindo a tampa, pode ser encomendada separadamente
- Caixa de ligação Y-IP68



Down 1950lm | 3000K

Versão	Art. n.º	EUR
● Aço inoxidável	1007244	479,00



Artigo	Art. n.º	EUR
Caixa de encastramento para DASAR® L		
● Preto	1007245	49,00
○ Refletor de 15° para DASAR® L / XL		
○ Prateado	1007238	12,00
○ Refletor de 36° para DASAR® L / XL		
○ Prateado	1007239	12,00
○ Refletor de 60° para DASAR® L / XL		
○ Prateado	1007240	12,00

# DASAR® XL

## RL, Redondo

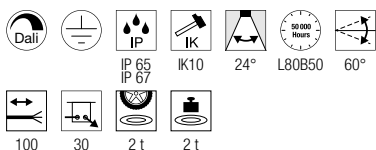
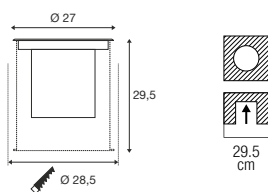

220-240V ~50/60Hz | 700mA  
 Potência do sistema: 27W  
 Material: alumínio

- Distribuição da luz convenientemente ajustável utilizando óticas intercambiáveis de 15°. 36° e 60°
- A Caixa de encastramento, incluindo a tampa, pode ser encomendada separadamente
- Caixa de ligação Y-IP68



Down 2790lm | 3000K

Versão	Art. n.º	EUR
● Aço inoxidável	<b>1007241</b>	<b>579,00</b>



Artigo	Art. n.º	EUR
Caixa de encastramento para DASAR® XL		
● Preto	<b>1007246</b>	<b>59,00</b>
Refletor de 15° para DASAR® L / XL		
○ Prateado	<b>1007238</b>	<b>12,00</b>
Refletor de 36° para DASAR® L / XL		
○ Prateado	<b>1007239</b>	<b>12,00</b>
Refletor de 60° para DASAR® L / XL		
○ Prateado	<b>1007240</b>	<b>12,00</b>



1007242 967



## DASAR® XL RL, Quadrado

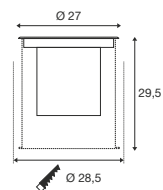

29,5  
cm

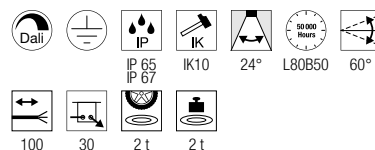

220-240V ~50/60Hz | 700mA  
Potência do sistema: 27W  
Material: alumínio

- Distribuição da luz convenientemente ajustável utilizando óticas intercambiáveis de 15°. 36° e 60°
- A Caixa de encastramento, incluindo a tampa, pode ser encomendada separadamente
- Caixa de ligação Y-IP68



Down 2790lm | 3000K

Versão	Art. n.º	EUR
● Aço inoxidável	<b>1007242</b>	<b>579,00</b>



Artigo	Art. n.º	EUR
Caixa de encastramento para DASAR® XL		
● Preto	<b>1007246</b>	<b>59,00</b>
Refletor de 15° para DASAR® L / XL		
○ Prateado	<b>1007238</b>	<b>12,00</b>
Refletor de 36° para DASAR® L / XL		
○ Prateado	<b>1007239</b>	<b>12,00</b>
Refletor de 60° para DASAR® L / XL		
○ Prateado	<b>1007240</b>	<b>12,00</b>



228412

969



229383

969





### DASAR® FLAT 80 EL

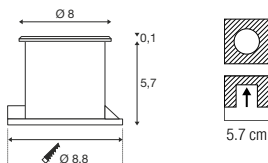

220-240V ~50/60Hz  
Potência do sistema: 3,5W  
Material: aço inoxidável 304/vidro

- Caixa de encastramento incluída
- A luminária é adequada para instalação em madeira.
- Extremidade do cabo aberta



Up 140lm | 3000K

Versão	Art. n.º	EUR
● Aço inoxidável	228412	109,00

### DASAR® FLAT 120 EL

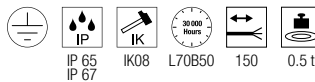
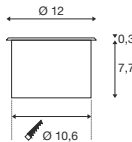

220-240V ~50/60Hz | 350mA  
Potência do sistema: 7W  
Material: aço inoxidável 304/alumínio

- Caixa de encastramento incluída
- Extremidade do cabo aberta



Down 490lm | 3000K  
540lm | 4000K

Versão	Art. n.º	EUR
● Aço inoxidável 490lm   3000K	1006106	151,00
● Aço inoxidável 540lm   4000K	1006107	151,00

### DASAR® 255 EL

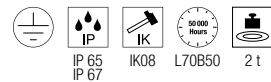
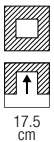
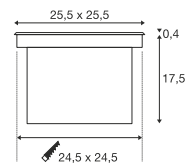

220-240V ~50/60Hz | 750mA  
Potência do sistema: 31W  
Material: aço inoxidável 316/vidro

- Caixa de encastramento incluída



Down 1660lm | 3000K  
1720lm | 4000K

Versão	Art. n.º	EUR
● Aço inoxidável 1660lm   3000K	229383	403,00
● Aço inoxidável 1720lm   4000K	229381	403,00



Artigo	Art. n.º	EUR
Caixa de ligação IP68, 3 pinos		
● Preto	228730	18,00

DASAR® 920  
EL

DASAR® 920  
EL

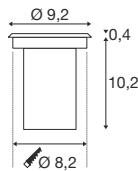
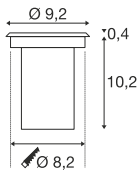

233500 970



12-24 V DC  
Potência do sistema: 6,5W  
Material: aço inoxidável 316/vidro

- Caixa de encastramento incluída
- Extremidade do cabo aberta

220-240V ~50/60Hz | 400mA  
Potência do sistema: 5,5W  
Material: aço inoxidável 316/vidro

- Caixa de encastramento incluída
- Extremidade do cabo aberta



Down 520lm | 3000K



Down 300lm | 3000K

Versão	Art. n.º	EUR
● Aço inoxidável	233500	151,00

Versão	Art. n.º	EUR
● Aço inoxidável	233520	197,00





DASAR® 270  
EL, Assimétrico

DASAR® 270  
EL, Simétrico

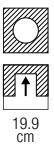
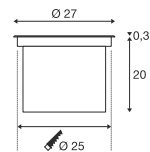
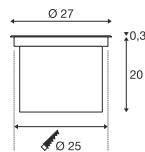

220-240V ~50/60Hz | 700mA  
Potência do sistema: 30W  
Material: aço inoxidável 316/vidro

• Caixa de encastramento incluída



Down 2200lm | 3000K

Versão	Art. n.º	EUR
● Aço inoxidável	1002893	454,00

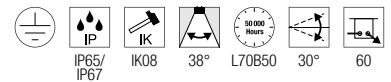

220-240V ~50/60Hz | 700mA  
Potência do sistema: 30W  
Material: aço inoxidável 316/vidro

• Caixa de encastramento incluída



Down 2500lm | 3000K

Versão	Art. n.º	EUR
● Aço inoxidável	1002897	454,00



Artigo	Art. n.º	EUR
DASAR® 270   Cobertura Honeycomb		
● Preto	1002899	12,90



229320 973



**DASAR® 115**  
RL, Redondo, QPAR51

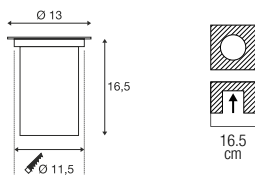

220-240V ~50/60Hz  
Material: aço inoxidável 316/vidro

- Caixa de encastramento incluída



Casquilho: 1xGU10 máx. Ø: 5,1 cm C: 6 cm

Versão	Art. n.º	EUR
● Aço inoxidável	229320	114,00



LED GU10 51 mm | 6W | 38°  
2700K | 450lm | CEE=F  
6 kWh/1000h



Art. N.º: 1005075 | 7,50 EUR

**DASAR® 115**  
RL, Quadrado, QPAR51

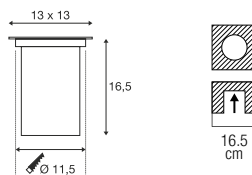

220-240V ~50/60Hz  
Material: aço inoxidável 316/vidro

- Caixa de encastramento incluída



Casquilho: 1xGU10 máx. Ø: 5,1 cm C: 6 cm

Versão	Art. n.º	EUR
● Aço inoxidável	229324	114,00



LED GU10 51 mm | 6W | 36°  
2200-2700K | 360lm | CEE=G  
6 kWh/1000h



Art. N.º: 1005273 | 9,99 EUR

**DASAR® 115**  
RL, Quadrado, QPAR51

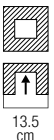
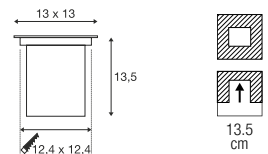

220-240V ~50/60Hz  
Material: aço inoxidável 316/vidro

- Caixa de encastramento incluída



Casquilho: 1xGU10 máx. Ø: 5,1 cm C: 6 cm

Versão	Art. n.º	EUR
● Aço inoxidável	229374	114,00



LED GU10 51 mm | 6W | 36°  
2200-2700K | 360lm | CEE=G  
6 kWh/1000h



Art. N.º: 1005273 | 9,99 EUR





**DASAR® EXACT 116**  
EL, Quadrado, QPAR51

**DASAR® EXACT 116**  
EL, Redondo, QPAR51

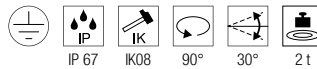
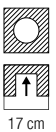
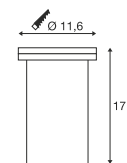
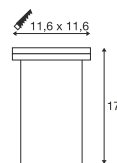

220-240V ~50/60Hz  
Material: aço inoxidável 316/vidro

- Caixa de encastramento incluída

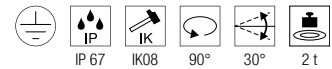

220-240V ~50/60Hz  
Material: aço inoxidável 316/vidro

- Caixa de encastramento incluída



Casquilho: 1xGU10 máx. Ø: 5,1 cm C: 6 cm

Versão	Art. n.º	EUR
● Aço inoxidável	228434	124,00



Casquilho: 1xGU10 máx. Ø: 5,1 cm C: 6 cm

Versão	Art. n.º	EUR
● Aço inoxidável	228430	124,00



LED GU10 51 mm | 6W | 38°  
2700K | 450lm | CEE=F  
6 kWh/1000h



Art. N.º: 1005075 | 7,50 EUR



LED GU10 51 mm | 6W | 36°  
2200-2700K | 360lm | CEE=G  
6 kWh/1000h



Art. N.º: 1005273 | 9,99 EUR

DASAR® 215  
RL, Redondo, QPAR111

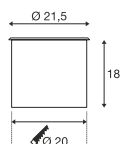

220-240V ~50/60Hz  
Material: aço inoxidável 316/vidro

- Caixa de encastramento incluída



Casquilho: 1xGU10

Versão	Art. n.º	EUR
● Aço inoxidável	229230	268,00



QPAR111 | 12,5W | 10°  
3000K | 950lm | CEE=F  
13 kWh/1000h



Art. N.º: 1005278 | 55,00 EUR

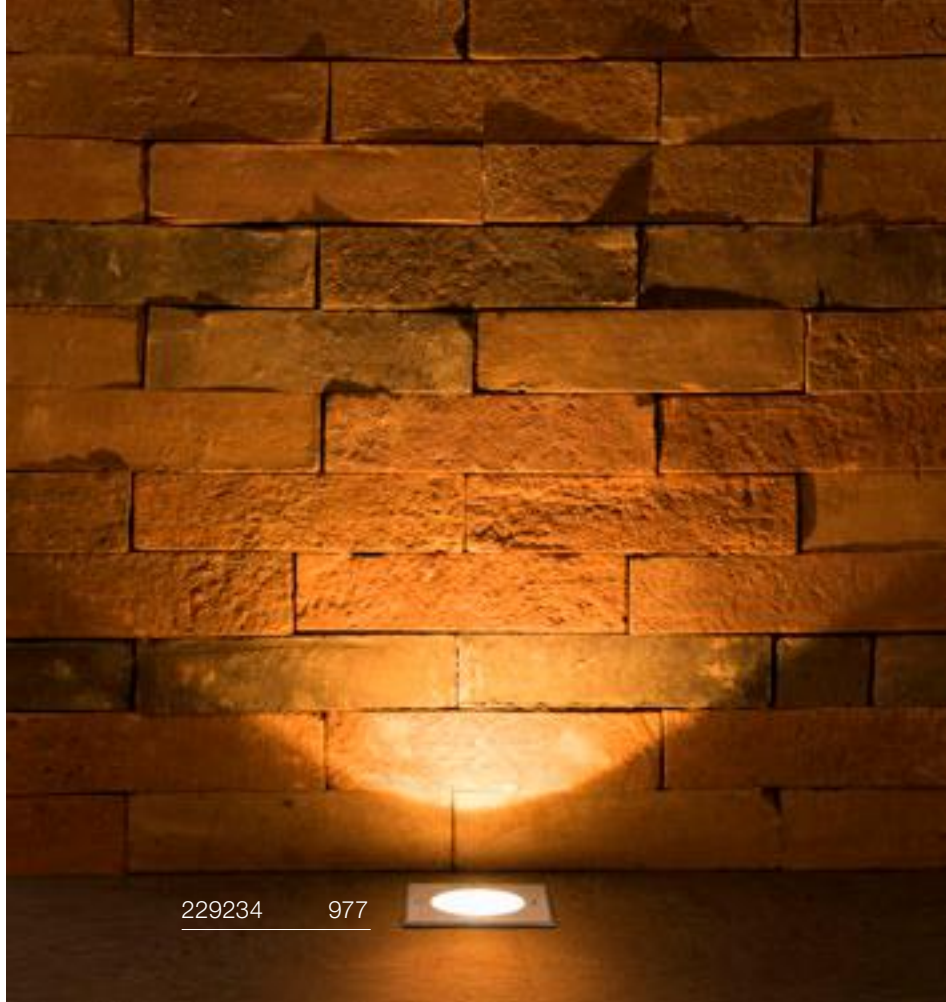

229234 977



229230 976





**DASAR® 215**  
RL, Quadrado, QPAR111

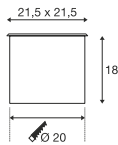

220-240V ~50/60Hz  
Material: aço inoxidável 316/vidro

- Caixa de encastramento incluída



Casquilho: 1xGU10

Versão	Art. n.º	EUR
● Aço inoxidável	229234	268,00



QPAR111 | 12,5W | 10°  
2700K | 900lm | CEE=G  
13 kWh/1000h



Art. N.º: 1005275 | 55,00 EUR

**DASAR® 215**  
RL, Redondo, E27

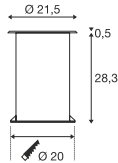

220-240V ~50/60Hz  
Material: aço inoxidável 316/vidro

- Caixa de encastramento incluída



Casquilho: 1xE27 máx. Ø: 4,5 cm | C: 13,4 cm

Versão	Art. n.º	EUR
● Aço inoxidável	229200	256,00



LED E27 | 8W | 240°  
3000K | 880lm | CEE=E  
8 kWh/1000h



Art. N.º: 1005289 | 10,25 EUR

**DASAR® 370**  
EL, Redondo

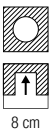
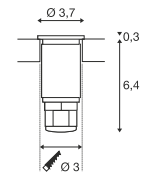

12-24 V DC  
Consumo de energia: 2W  
Material: aço inoxidável 316/vidro

- A luminária é adequada para instalação em madeira
- Extremidade do cabo aberta



Down 120lm | 3000K

Versão	Art. n.º	EUR
● Aço inoxidável	233540	171,00

# TRAIL-LITE® 60 EL

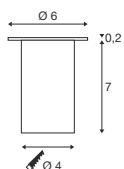

7 cm



IP 65 IK08 L70B50 40

12V ~50/60Hz

Consumo de energia: 0,3W

Material: aço inoxidável 316/vidro

- Funcionamento apenas com transformador convencional
- Caixa de encastramento incluída
- A luminária é adequada para instalação em madeira



Down

4lm | 3000K

Versão	Art. n.º	EUR
● Aço inoxidável	227462	70,00

228332 979

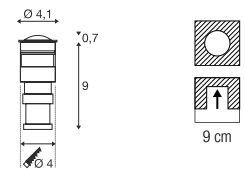
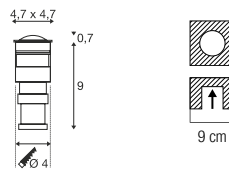
**POWER TRAIL-LITE®**  
EL, Quadrado**POWER TRAIL-LITE®**  
EL, Redondo

350mA  
Consumo de energia: 1W  
Material: aço inoxidável 316/vidro

- Funcionamento apenas com controlador 350 mA. A ligação de vários LED de potência apenas deve ser feita com ligação em série Com Caixa de encastramento tubular
- A luminária é adequada para instalação em madeira
- Extremidade do cabo aberta

350mA  
Consumo de energia: 1W  
Material: aço inoxidável 316/vidro

- Funcionamento apenas com controlador 350 mA. A ligação de vários LED de potência apenas deve ser feita com ligação em série
- A luminária é adequada para instalação em madeira
- Extremidade do cabo aberta



Down 45lm | 3000K

Down 45lm | 3000K

Versão	Art. n.º	EUR
● Aço inoxidável	228342	80,00

Versão	Art. n.º	EUR
● Aço inoxidável	228332	80,00





### SMALL PLOT Módulos

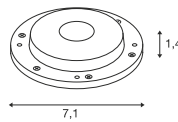
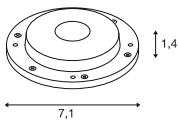

24 V DC  
Consumo de energia: 2,6W  
Material: alumínio/polimetilacrilato (PMMA)

- O produto é entregue sem tampa.
- Extremidade do cabo aberta



Down 240lm | 3000K

Versão	Art. n.º	EUR
● Alumínio	1006172	79,00

### SMALL PLOT Módulos



24 V DC  
Consumo de energia: 2,6W  
Material:  
aço inoxidável/polimetilacrilato (PMMA)

- O produto é entregue sem tampa.
- Extremidade do cabo aberta



Down 240lm | 3000K

Versão	Art. n.º	EUR
● Aço inoxidável	1006171	94,00

### SMALL PLOT Cobertura, 2 peças



500 kg

A: 1,7 cm  
Ø: 10,3 cm  
Material: alumínio

Versão	Art. n.º	EUR
● Antracite	1006174	42,25
● Aço inoxidável	1006173	139,00

### SMALL PLOT Cobertura, 4 peças



800 kg

A: 1,7 cm  
Ø: 10,3 cm  
Material: aço inoxidável

Versão	Art. n.º	EUR
● Antracite	1006176	42,25
● Aço inoxidável	1006175	139,00



1001359 + 1001255 983



### BIG PLOT Módulos

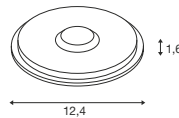
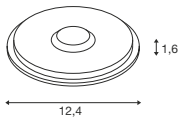

220-240V ~50/60Hz  
Potência do sistema: 4,9W  
Material: alumínio/polimetilacrilato (PMMA)

- O produto é entregue sem tampa
- Extremidade do cabo aberta



Down 540lm | 3000K

Versão	Art. n.º	EUR
● Alumínio	<b>1008000</b>	<b>92,00</b>



Artigo	Art. n.º	EUR
Caixa de conector em T		
● Preto	<b>228726</b>	<b>33,00</b>
Caixa de ligação IP68, 3 pinos		
● Preto	<b>228730</b>	<b>18,00</b>

### BIG PLOT Módulos



220-240V ~50/60Hz  
Potência do sistema: 4,9W  
Material: aço inoxidável/polimetilacrilato (PMMA)

- O produto é entregue sem tampa
- Extremidade do cabo aberta



Down 540lm | 3000K

Versão	Art. n.º	EUR
● Aço inoxidável	<b>1008001</b>	<b>133,00</b>



Artigo	Art. n.º	EUR
Caixa de conector em T		
● Preto	<b>228726</b>	<b>33,00</b>
Caixa de ligação IP68, 3 pinos		
● Preto	<b>228730</b>	<b>18,00</b>

### BIG PLOT Cobertura, 2 peças



500 kg

A: 2 cm  
Ø: 17 cm  
Material: alumínio

- 1001262 até 0,5 t de capacidade de carga
- 1001254 até 0,8 t de capacidade de carga

Versão	Art. n.º	EUR
● Antracite	<b>1001262</b>	<b>56,00</b>
● Aço inoxidável	<b>1001254</b>	<b>198,00</b>

### BIG PLOT Cobertura, 4 peças



800 kg

A: 2 cm  
Ø: 17 cm  
Material: aço inoxidável 316

- 1001255 até 0,8 t de capacidade de carga
- 1001263 até 0,8 t de capacidade de carga

Versão	Art. n.º	EUR
● Antracite	<b>1001263</b>	<b>56,00</b>
● Aço inoxidável	<b>1001255</b>	<b>198,00</b>

ROCCI  
EL, Quadrado

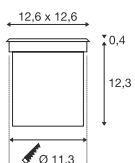

100-277V ~50/60Hz | 700mA  
Potência do sistema: 8,6W  
Material: aço inoxidável 316/vidro

- Caixa de encastramento incluída



Up 580lm | 3000K

Versão	Art. n.º	EUR
● Aço inoxidável	227604	167,00

ROCCI  
EL, Redondo

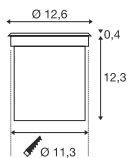

100-277V ~50/60Hz | 700mA  
Potência do sistema: 8,6W  
Material: aço inoxidável 316/vidro

- Caixa de encastramento incluída



Up 580lm | 3000K

Versão	Art. n.º	EUR
● Aço inoxidável	227600	167,00

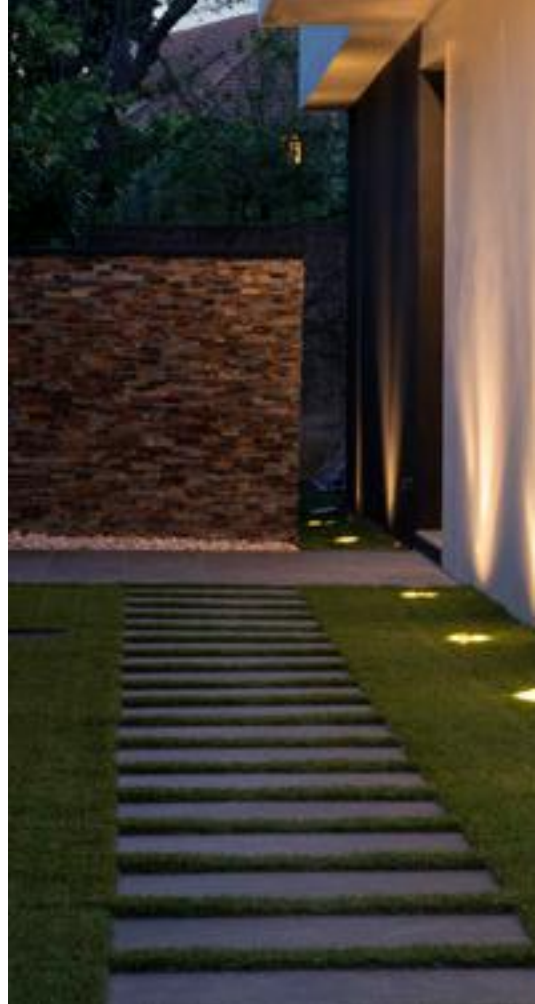





ROCCI 200  
EL, Quadrado

ROCCI 200  
EL, Redondo

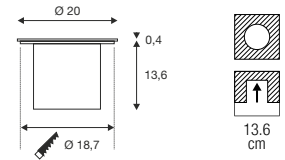
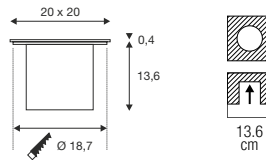

227604 984

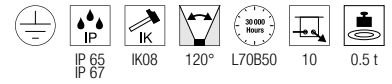
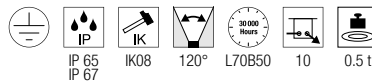

100-277V ~50/60Hz | 350mA  
Potência do sistema: 16W  
Material: aço inoxidável 316/vidro

100-277V ~50/60Hz | 350mA  
Potência do sistema: 16W  
Material: aço inoxidável 316/vidro

• Caixa de encastramento incluída

• Caixa de encastramento incluída



Up 1530lm | 3000K



Up 1530lm | 3000K

Versão	Art. n.º	EUR
● Aço inoxidável	1006105	187,00

Versão	Art. n.º	EUR
● Aço inoxidável	1006104	187,00

1006105 985





### SOLASTO EL, Quadrado

### SOLASTO EL, Redondo

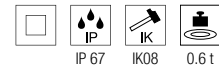
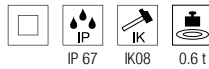
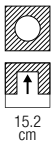
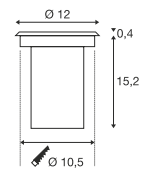
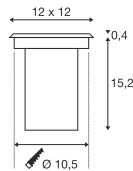

220-240V ~50/60Hz  
Material: aço inoxidável 304/vidro

220-240V ~50/60Hz  
Material: aço inoxidável 304/vidro

- Caixa de encastramento incluída

- Caixa de encastramento incluída



Casquilho: 1xGU10

Casquilho: 1xGU10

Versão	Art. n.º	EUR
● Aço inoxidável	227684	69,00

Versão	Art. n.º	EUR
● Aço inoxidável	227680	69,00



LED GU10 51 mm | 6W | 38°  
2700K | 450lm | CEE=F  
6 kWh/1000h



Art. N.º: 1005077 | 7,50 EUR



LED GU10 51 mm | 6W | 38°  
2700K | 450lm | CEE=F  
6 kWh/1000h













































Art. N.º: 1005075 | 7,50 EUR

1007655 1002





 NEW LED PANEL C 600   990	 NEW LED PANEL C DALI 600   991	 NEW LED PANEL C 625   993	 NEW LED PANEL C DALI 625   993	 NEW LED PANEL C 1200   995	 NEW LED PANEL C DALI 1200   995
 LED PANEL V 600   996	 LED PANEL V 600   997	 LED PANEL V DALI 600   997	 LED PANEL V 625   998	 LED PANEL V 625   999	 LED PANEL V DALI 625   999
 LED SURFACE V 390   1001	 LED SURFACE V 390   1001	 LED TRACKSPOT V   1002	 LED TRACKSPOT V   1003	 NEW LED DOWNLIGHT C   1005	 NEW LED DOWNLIGHT C   1005
 LED DOWNLIGHT C   1006	 LED DOWNLIGHT C   1007	 LED DOWNLIGHT V 100   1008	 LED DOWNLIGHT V 150   1008	 LED DOWNLIGHT V 200   1008	 NEW LED UNIVERSAL DOWNLIGHT   1011
 NEW LED WATERPROOF V 600   1013	 NEW LED WATERPROOF V DALI 600   1013	 NEW LED WATERPROOF V 1200   1014	 NEW LED WATERPROOF V DALI 1200   1015	 NEW LED WATERPROOF V 1500   1017	 NEW LED WATERPROOF V DALI 1500   1017
 NEW LED INDUSTRY BATTEN V 1200   1018	 NEW LED INDUSTRY BATTEN V 1500   1019	 NEW LED HIGHBAY C 340   1021	 NEW LED HIGHBAY C 400   1021	 NEW LED HIGHBAY C DALI 400   1021	 NEW LED HIGHBAY V 330   1024
 NEW LED OUTDOOR BULKHEAD V 360   1027	 NEW LED OUTDOOR BULKHEAD V 360   1027	 LED FLOODI S   1029	 LED FLOODI M   1029	 LED FLOODI L   1029	 NEW LED LED TUBE   1031

PANEL C 600  
34W 830/840 UGR

1008597 990

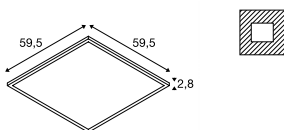

220-240V ~50/60Hz | 850mA  
Potência do sistema: 34W  
Material: alumínio

- IP 54 (lado do compartimento iluminado)



Down 4550lm | 3000K | 4650lm | 4000K

Versão	Art. n.º	EUR
<input type="radio"/> Branco	1008597	<input checked="" type="radio"/> 114,00



## PANEL C DALI 600

34W 830/840 UGR



NEW

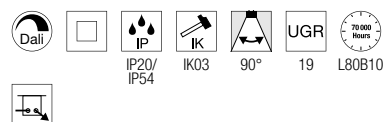
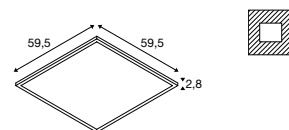

220-240V ~50/60Hz | 850 mA  
Potência do sistema: 34W  
Material: alumínio

IP 54 (lado do compartimento iluminado)  
Com capacidade de alimentação por corrente contínua



Down 4550lm | 3000K | 4650lm | 4000K

Versão	Art. n.º	EUR
<input type="radio"/> Branco	1008601	<input checked="" type="radio"/> 114,00

1008598 993







PANEL C 625  
34W 830/840 UGR

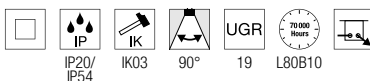
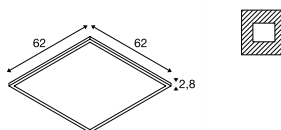

220-240V ~50/60Hz | 850mA  
Potência do sistema: 34W  
Material: alumínio

- IP 54 (lado do compartimento iluminado)



Down 4550lm | 3000K | 4650lm | 4000K

Versão	Art. n.º	EUR
<input type="radio"/> Branco	1008598	<input checked="" type="radio"/> 114,00

PANEL C DALI 625  
34W 830/840 UGR

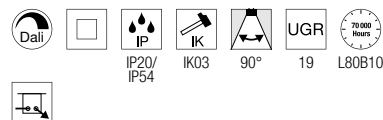
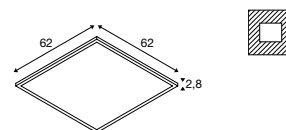

220-240V ~50/60Hz | 850 mA  
Potência do sistema: 34W  
Material: alumínio

- IP 54 (lado do compartimento iluminado)
- Com capacidade de alimentação por corrente contínua



Down 4550lm | 3000K | 4650lm | 4000K

Versão	Art. n.º	EUR
<input type="radio"/> Branco	1008602	<input checked="" type="radio"/> 114,00

1008607 995





## PANEL C 1200

34W 830/840 UGR



## PANEL C DALI 1200

34W 830/840 UGR

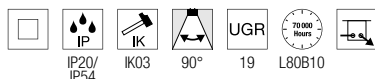
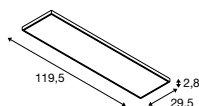
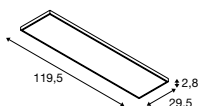

220-240V ~50/60Hz | 850 mA  
Potência do sistema: 34W  
Material: alumínio

- IP 54 (lado do compartimento iluminado)



Down 4550lm | 3000K | 4650lm | 4000K

Versão	Art. n.º	EUR
<input type="radio"/> Branco	1008605	139,00

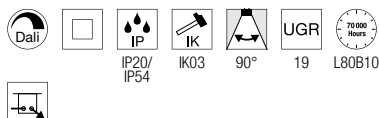

220-240V ~50/60Hz | 850 mA  
Potência do sistema: 34W  
Material: alumínio

- IP 54 (lado do compartimento iluminado)
- Com capacidade de alimentação por corrente contínua



Down 4550lm | 3000K | 4650lm | 4000K

Versão	Art. n.º	EUR
<input type="radio"/> Branco	1008607	139,00

## PANEL C

Conjunto de suspensão 1500



C: 150 cm  
Material: aço

Versão	Art. n.º	EUR
<input type="radio"/> Prateado	1008609	19,90

## PANEL C

Molas de fixação



C: 4 cm L: 3,5 cm A: 3,2 cm  
Material: aço

Versão	Art. n.º	EUR
<input type="radio"/> Prateado	1008610	14,90

1007504 997

## PANEL V 600 34W 830/840

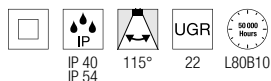

220-240V ~50/60Hz | 900mA  
Potência do sistema: 34W  
Material: aço/alumínio

- Espessura do material da área de instalação: máx. 30 mm
- IP 54 (lado do compartimento iluminado)



IRC 80

Down 4100lm | 3000K | 4300lm | 4000K

Versão	Art. n.º	EUR
<input type="radio"/> Branco	1007496	65,00



Artigo	Art. n.º	EUR
<input type="radio"/> Cabo de segurança 1,5 m		
<input checked="" type="radio"/> Aço inoxidável	1007577	15,00



PANEL V 600  
34W 830/840 UGR



PANEL V DALI 600  
34W 830/840 UGR



PANEL 600  
Aro de montagem, saliente



C: 60 cm  
L: 60 cm  
A: 6,3 cm  
Material: aço

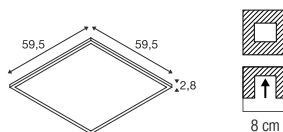
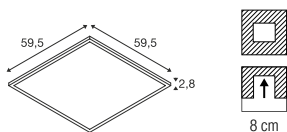

Versão	Art. n.º	EUR
<input type="radio"/> Branco	1007474	45,00

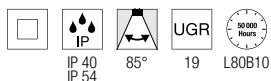

220-240V ~50/60Hz | 900mA  
Potência do sistema: 34W  
Material: aço/alumínio

- Espessura do material da área de instalação: máx. 30 mm
- IP 54 (lado do compartimento iluminado)



Down 4000lm | 3000K | 4200lm | 4000K

Versão	Art. n.º	EUR
<input type="radio"/> Branco	1007498	75,00



Artigo	Art. n.º	EUR
Cabo de segurança 1,5 m		
<input checked="" type="radio"/> Aço inoxidável	1007577	15,00

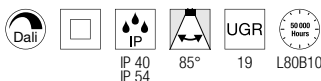

200-240V ~50/60Hz | 900mA  
Potência do sistema: 34W  
Material: aço/alumínio

- Espessura do material da área de instalação: máx. 30 mm
- IP 54 (lado do compartimento iluminado)



Down 4000lm | 3000K | 4200lm | 4000K

Versão	Art. n.º	EUR
<input type="radio"/> Branco	1007504	110,00



Artigo	Art. n.º	EUR
Cabo de segurança 1,5 m		
<input checked="" type="radio"/> Aço inoxidável	1007577	15,00

PANEL 600  
Aro recuado, encastrar



C: 60 cm  
L: 60 cm  
A: 7,1 cm  
Material: aço

Versão	Art. n.º	EUR
<input type="radio"/> Branco	1007575	65,00

PANEL V 625  
34W 830/840

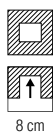
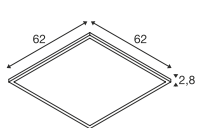

220-240V ~50/60Hz | 900mA  
Potência do sistema: 34W  
Material: aço/alumínio

- Espessura do material da área de instalação: máx. 30 mm
- IP 54 (lado do compartimento iluminado)



Down 4100lm | 3000K | 4300lm | 4000K

Versão	Art. n.º	EUR
<input type="radio"/> Branco	1007497	65,00



Artigo	Art. n.º	EUR
Cabo de segurança 1,5 m		
<input checked="" type="radio"/> Aço inoxidável	1007577	15,00

1007499 999



## PANEL V 625

34W 830/840 UGR



## PANEL V DALI 625

34W 830/840 UGR



## PANEL 625

Aro de montagem, saliente



C: 62,5 cm  
L: 62,5 cm  
A: 6,3 cm  
Material: aço

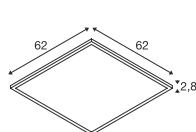
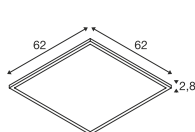

Versão	Art. n.º	EUR
<input type="radio"/> Branco	1007475	45,00

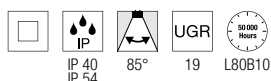

220-240V ~50/60Hz | 900mA  
Potência do sistema: 34W  
Material: aço/alumínio

- Espessura do material da área de instalação: máx. 30 mm
- IP 54 (lado do compartimento iluminado)



Down 4000lm | 3000K | 4200lm | 4000K

Versão	Art. n.º	EUR
<input type="radio"/> Branco	1007499	75,00



Artigo	Art. n.º	EUR
Cabo de segurança 1,5 m		
<input checked="" type="radio"/> Aço inoxidável	1007577	15,00

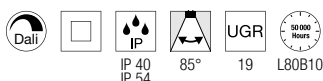

200-240V ~50/60Hz | 900mA  
Potência do sistema: 34W  
Material: aço/alumínio

- Espessura do material da área de instalação: máx. 30 mm
- IP 54 (lado do compartimento iluminado)



Down 4000lm | 3000K | 4200lm | 4000K

Versão	Art. n.º	EUR
<input type="radio"/> Branco	1007505	110,00



Artigo	Art. n.º	EUR
Cabo de segurança 1,5 m		
<input checked="" type="radio"/> Aço inoxidável	1007577	15,00

## PANEL 625

Aro recuado, encastrar



C: 62,5 cm  
L: 62,5 cm  
A: 7,1 cm  
Material: aço

Versão	Art. n.º	EUR
<input type="radio"/> Branco	1007576	65,00

1007517 1001







**SURFACE V 390**  
10/15/20W 830/840 IP44

**SURFACE V 390**  
10/15/20W 830/840 IP44 Sensor

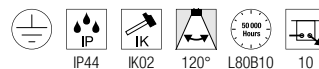
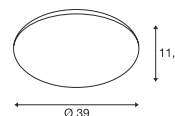
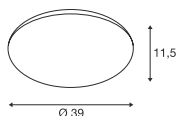

220-240V ~50/60Hz | 165/120/84mA  
Potência do sistema: 20W  
Material: aço

220-240V ~50/60Hz | 165/120/84mA  
Potência do sistema: 20W  
Material: aço



Down 1850lm | 3000K | 2000lm | 4000K

Down 1850lm | 3000K | 2000lm | 4000K

Versão	Art. n.º	EUR
<input type="radio"/> Branco	1007516	50,00

Versão	Art. n.º	EUR
<input type="radio"/> Branco	1007517	65,00

TRACKSPOT V  
3Ph. 10/15/20W  
927/930/940 24...60°



1007655 1002

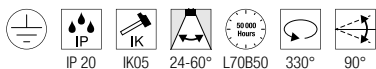
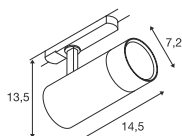

220-240V ~50/60Hz | 240/380/500mA  
Potência do sistema: 20W  
Material: alumínio/policarbonato (PC)

- Podem ser definidas três temperaturas de cor da luz, variando os valores de lúmen consoante a seleção. Só são apresentados os valores mínimos e máximos de todas as definições



1800lm | 2700K | 1980lm | 3000K | 1920lm | 4000K

Versão	Art. n.º	EUR
● Preto	1007655	159,00
○ Branco	1007654	159,00



## TRACKSPOT V

3Ph. 25/30/35W  
927/930/940 24...60°

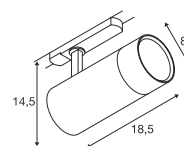

220-240V ~50/60Hz | 620/750/850mA  
Potência do sistema: 35W  
Material: alumínio/polycarbonato (PC)

- Podem ser definidas três temperaturas de cor da luz, variando os valores de lúmen consoante a seleção. Só são apresentados os valores mínimos e máximos de todas as definições



3090lm | 2700K | 3470lm | 3000K | 3300lm | 4000K

Versão	Art. n.º	EUR
● Preto	<b>1007657</b>	<b>179,00</b>
○ Branco	<b>1007656</b>	<b>179,00</b>

1007657 1003





### DOWNLIGHT C 150 930/940 IP54

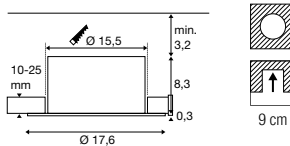

220-240V ~50/60Hz | 200/350/500mA  
Potência do sistema: 8|14|20W  
Material: alumínio

- Espessura do material da área de instalação: máx. 25 mm.



8W	950lm	3000K
	1000lm	4000K
14W	1550lm	3000K
	1650lm	4000K
20W	2250lm	3000K
	2400lm	4000K

Versão	Art. n.º	EUR
○ Branco 3000K	<b>1008621</b>	<b>89,00</b>
○ Branco 4000K	<b>1008622</b>	<b>89,00</b>

### DOWNLIGHT C 200 930/940 IP54

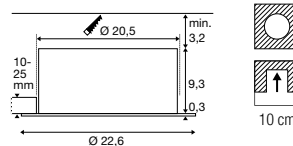

220-240V ~50/60Hz | 200/400/600mA  
Potência do sistema: 8|16|24W  
Material: alumínio

- Espessura do material da área de instalação: máx. 25 mm.



8W	1000lm	3000K
	1080lm	4000K
16W	1900lm	3000K
	2050lm	4000K
24W	2850lm	3000K
	3100lm	4000K

Versão	Art. n.º	EUR
○ Branco 3000K	<b>1008623</b>	<b>109,00</b>
○ Branco 4000K	<b>1008624</b>	<b>109,00</b>

DOWNLIGHT C  
150 930/940 DALI IP54

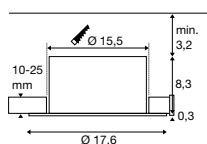

220-240V ~50/60Hz | 500mA  
Potência do sistema: 20W  
Material: alumínio

- Espessura do material da área de instalação: máx. 25 mm.
- Com capacidade de alimentação por corrente contínua



Down 2250lm | 3000K  
2400lm | 4000K

Versão	Art. n.º	EUR
○ Branco 2250lm   3000K	1008625	129,00
○ Branco 2400lm   4000K	1008626	129,00

## DOWNLIGHT C

### 200 930/940 DALI IP54

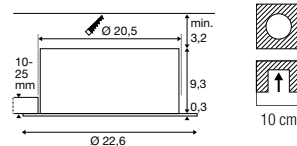
220-240V ~50/60Hz | 600mA  
Potência do sistema: 24W  
Material: alumínio

- Espessura do material da área de instalação: máx. 25 mm.
- Com capacidade de alimentação por corrente contínua



Down	2850lm   3000K	3100lm   4000K
------	----------------	----------------

Versão	Art. n.º	EUR
○ Branco 2850lm   3000K	<b>1008627</b>	<b>149,00</b>
○ Branco 3100lm   4000K	<b>1008628</b>	<b>149,00</b>

DOWNLIGHT V 100  
6W 830/840 IP54

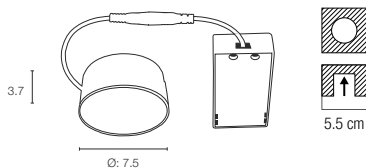

220-240V ~50/60Hz | 140mA  
Potência do sistema: 6W  
Material: poliamida (PA)



Down 610lm | 3000K | 640lm | 4000K

Versão	Art. n.º	EUR
● Preto	1007508	● 45,00

DOWNLIGHT V 150  
9/15W 830/840 IP54

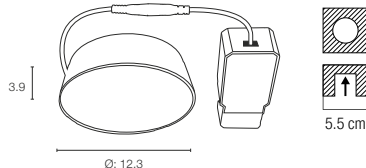

220-240V ~50/60Hz | 250/400mA  
Potência do sistema: 9/15W  
Material: poliamida (PA)



Down 1750lm | 3000K | 1900lm | 4000K

Versão	Art. n.º	EUR
● Preto	1007509	● 53,00

DOWNLIGHT V 200  
15/21W 830/840 IP54

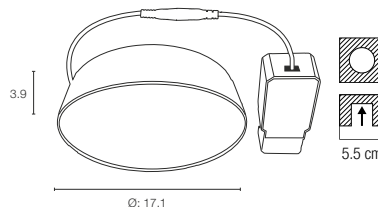

220-240V ~50/60Hz | 380/550mA  
Potência do sistema: 15/21W  
Material: poliamida (PA)



Down 2360lm | 3000K | 2490lm | 4000K

Versão	Art. n.º	EUR
● Preto	1007510	● 60,00



O DOWNLIGHT V só deve ser utilizado em conjunto com os aros de remate da próxima página





**DOWNLIGHT V 100**  
**Aro de remate, plano**

Polycarbonato (PC)  
 A: 2,5 cm  
 Ø: 10,6 cm



Versão	Art. n.º	EUR
● Preto	1007477	5,00
○ Branco	1007476	5,00

**DOWNLIGHT V 150**  
**Aro de remate, plano**

Polycarbonato (PC)  
 A: 2,5 cm  
 Ø: 16,8 cm



Versão	Art. n.º	EUR
● Preto	1007481	7,00
○ Branco	1007480	7,00

**DOWNLIGHT V 200**  
**Aro de remate, plano**

Polycarbonato (PC)  
 A: 2,5 cm  
 Ø: 21,4 cm



Versão	Art. n.º	EUR
● Preto	1007485	10,00
○ Branco	1007484	10,00

**DOWNLIGHT V 100**  
**Aro de remate, recuado**

Polycarbonato (PC)  
 A: 2,5 cm  
 Ø: 11 cm



Versão	Art. n.º	EUR
● Preto	1007479	5,00
○ Branco	1007478	5,00

**DOWNLIGHT V 150**  
**Aro de remate, recuado**

Polycarbonato (PC)  
 A: 2,5 cm  
 Ø: 17,6 cm



Versão	Art. n.º	EUR
● Preto	1007483	7,00
○ Branco	1007482	7,00

**DOWNLIGHT V 200**  
**Aro de remate, recuado**

Polycarbonato (PC)  
 A: 2,5 cm  
 Ø: 22,6 cm



Versão	Art. n.º	EUR
● Preto	1007487	10,00
○ Branco	1007486	10,00

1008066 + 1008096 1011



1008066 + 1008095 1011

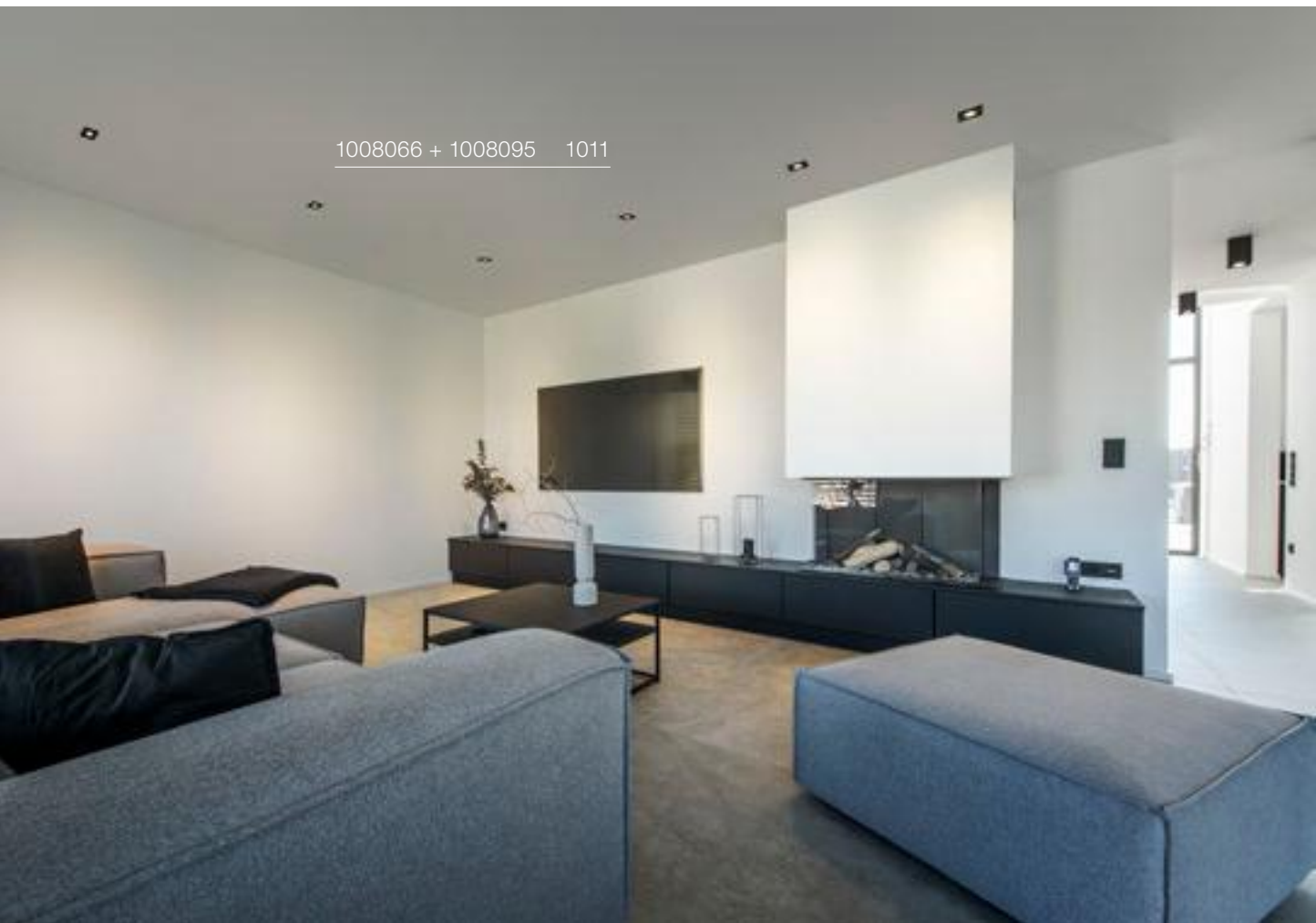



## UNIVERSAL DOWNLIGHT DL, PHASE, lote



NEW

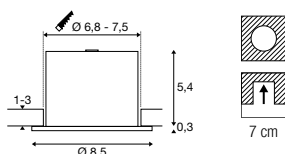
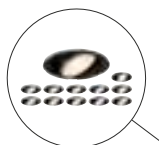

10

220-240V ~50/60Hz | 60mA  
Potência do sistema: 5 W/7W  
Material: aço

- Espessura do material da área de instalação: máx. 30 mm
- Conteúdo: 12 peças
- O lote é fornecido sem aros, devem ser encomendados separadamente



5W	470lm	2700K
	490lm	3000K
	500lm	4000K
	490lm	6500K
7W	670lm	2700K
	680lm	3000K
	690lm	4000K
	680lm	6500K

Versão	Art. n.º	EUR
● Preto	1008066	● 289,00

## UNIVERSAL DOWNLIGHT Aro fixo, redondo



Ø: 8,8 cm  
A: 0,5 cm  
Material: policarbonato (PC)

Versão	Art. n.º	EUR
● Preto	1008067	3,00
○ Branco	1008068	3,00

## UNIVERSAL DOWNLIGHT Aro fixo, quadrado



C: 8,8 cm  
L: 8,8 cm  
A: 0,55 cm  
Material: policarbonato (PC)

Versão	Art. n.º	EUR
● Preto	1008096	3,00
○ Branco	1008095	3,00

## UNIVERSAL DOWNLIGHT Aro orientável, redondo



Ø: 8,8 cm  
A: 0,35 cm  
Material: policarbonato (PC)

Versão	Art. n.º	EUR
● Preto	1007091	4,00
○ Branco	1007092	4,00

## UNIVERSAL DOWNLIGHT Aro orientável, quadrado



C: 8,8 cm  
L: 8,8 cm  
A: 0,35 cm  
Material: policarbonato (PC)

Versão	Art. n.º	EUR
● Preto	1007184	4,00
○ Branco	1007185	4,00

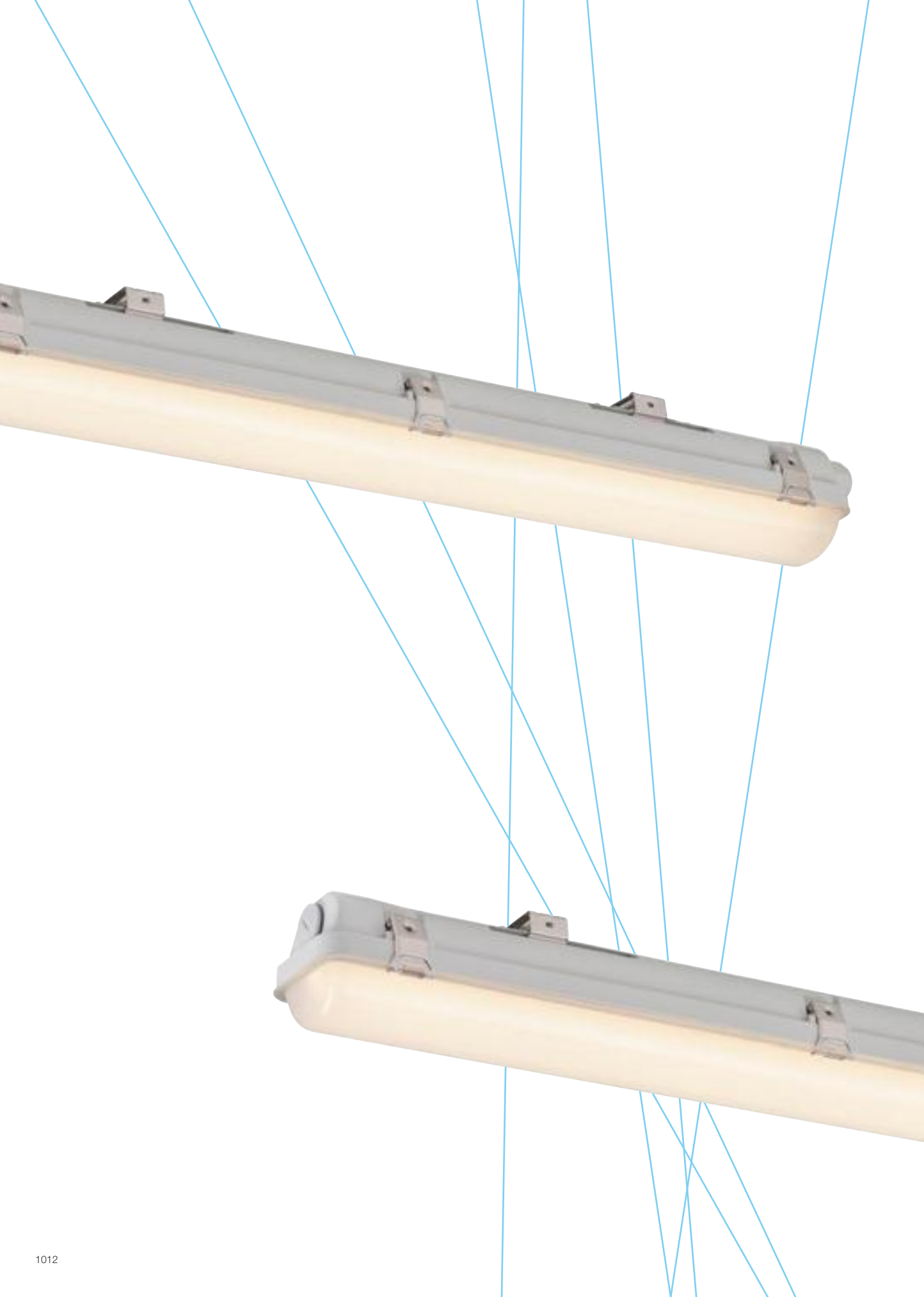



**WATERPROOF V 600**  
9/18W 830/840 IP66

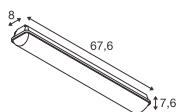

220-240V ~50/60Hz | 350/300/250mA  
Potência do sistema: 17W  
Material: policarbonato (PC)



Down 2010lm | 3000K | 2120lm | 4000K

Versão	Art. n.º	EUR
● Cinzento	1008088	● 65,00

**WATERPROOF V DALI 600**  
18W 840 IP66

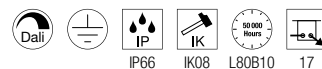
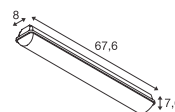

220-240V ~50/60Hz | 250mA  
Potência do sistema: 18W  
Material: policarbonato (PC)



Down 2380lm | 4000K

Versão	Art. n.º	EUR
● Cinzento	1008087	● 115,00



# WATERPROOF V 1200

18/32W 830/840 IP66

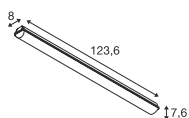

220-240V ~50/60Hz | 350/300/250mA  
Potência do sistema: 18 W/32W  
Material: policarbonato (PC)



Down 3860lm | 3000K | 4130lm | 4000K

Versão	Art. n.º	EUR
● Cinzento	1007490	● 80,00

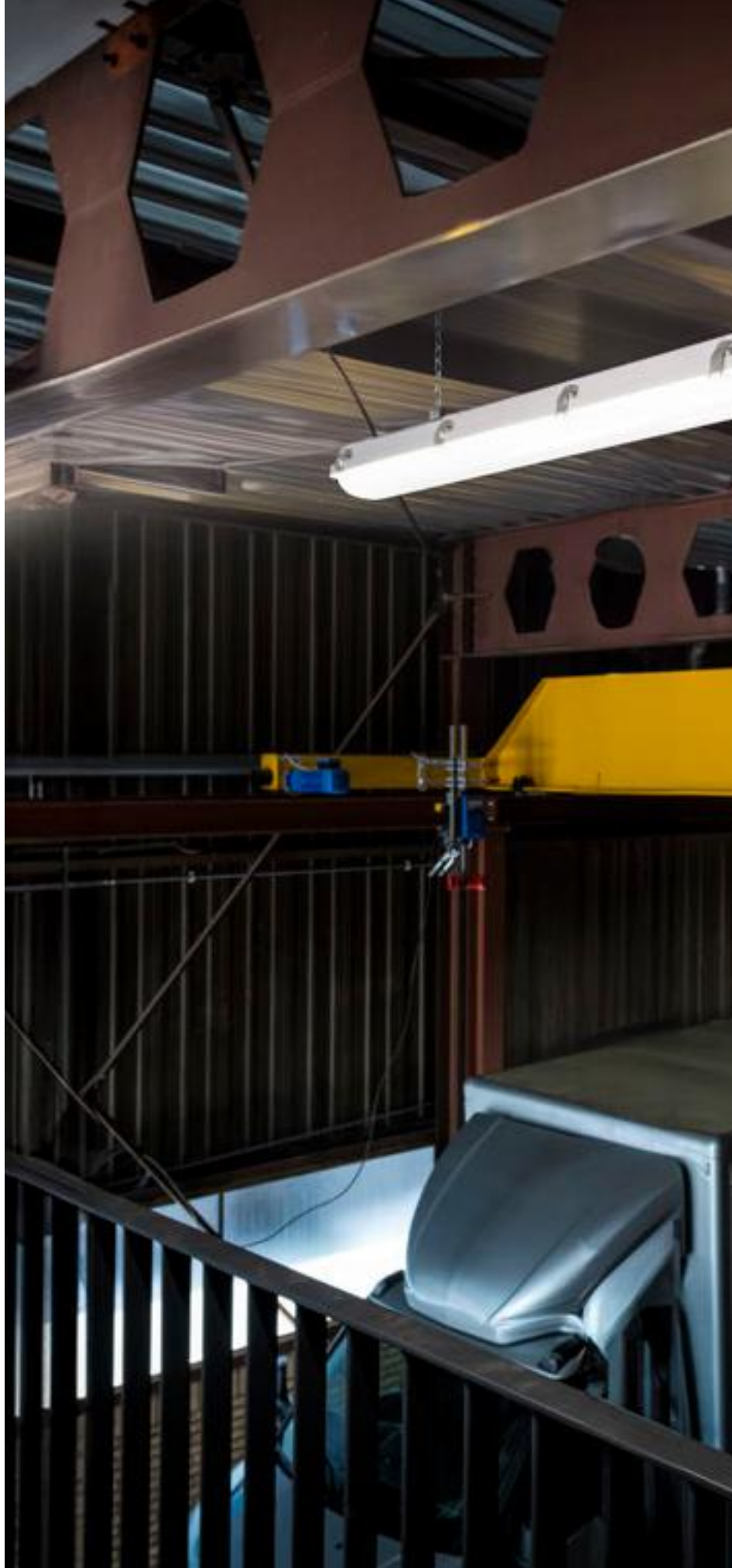

## WATERPROOF V DALI 1200 36W 840 IP66



NEW

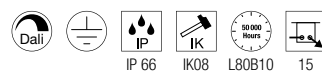
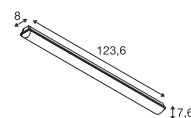

220-240V ~50/60Hz | 350mA  
Potência do sistema: 36W  
Material: policarbonato (PC)



Down

4470lm | 4000K

Versão	Art. n.º	EUR
● Cinzento	<b>1007493</b>	● 135,00

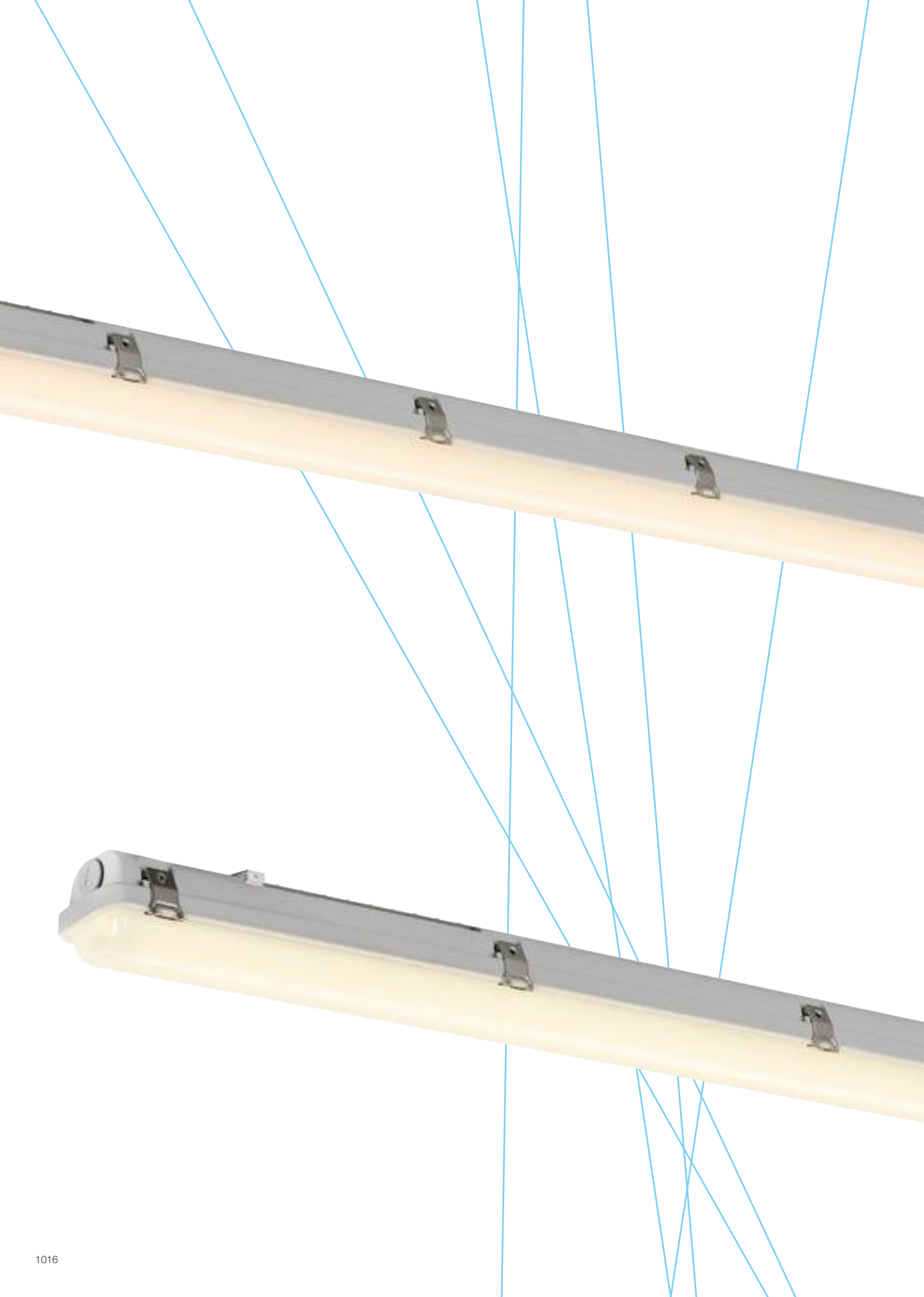



### WATERPROOF V 1500 26/45W 830/840 IP66

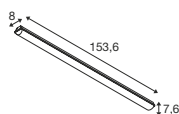

220-240V ~50/60Hz | 350/300/250mA  
Potência do sistema: 26 W/45W  
Material: policarbonato (PC)



Down 5670lm | 3000K | 5970lm | 4000K

Versão	Art. n.º	EUR
● Cinzento	1007491	● 95,00

### WATERPROOF V DALI 1500 50W 840 IP66

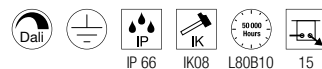
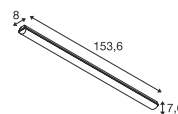

220-240V ~50/60Hz | 350mA  
Potência do sistema: 50W  
Material: policarbonato (PC)



Down 6640lm | 4000K

Versão	Art. n.º	EUR
● Cinzento	1007495	● 150,00



INDUSTRY BATTEN V 1200  
18/32W 830/840/857

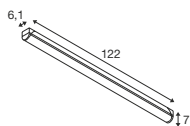

220-240V ~50/60Hz | 400/720mA  
Potência do sistema: 18/32W  
Material: aço



18W	2300lm	3000K
	2500lm	4000K
32W	2450lm	5700K
	3910lm	3000K
	4350lm	4000K
	4140lm	5700K

Versão	Art. n.º	EUR
<input type="radio"/> Branco	1007506	<input checked="" type="radio"/> 70,00



## INDUSTRY BATTEN V 1500

22/42W 830/840/857



NEW



1007507 1019

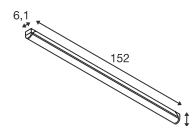

220-240V ~50/60Hz | 500/960mA

Potência do sistema: 22/42W

Material: aço



22W	2900lm	3000K
	3150lm	4000K
	3100lm	5700K
42W	5220lm	3000K
	5760lm	4000K
	5460lm	5700K

Versão	Art. n.º	EUR
<input type="radio"/> Branco	1007507	<input checked="" type="radio"/> 85,00



1008526 1021



### HIGHBAY C 340

60/80/100W 840 IP65

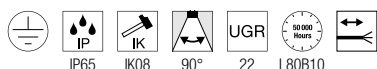
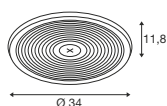

220-240V ~50/60Hz | 260/350/440mA  
 Potência do sistema: 55|78|100W  
 Material: alumínio

- Extremidade do cabo aberta



55W	9700lm	4000K
78W	13650lm	
100W	17500lm	

Versão	Art. n.º	EUR
● Preto	1008525	● 269,00



Artigo	Art. n.º	EUR
Caixa de ligação IP68 3 pinos		
● Preto	228730	18,00

### HIGHBAY C 400

120/160/200W 840 IP65

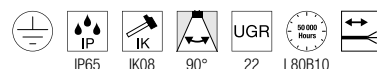
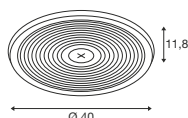

220-240V ~50/60Hz | 530/700/880mA  
 Potência do sistema: 120|160|200W  
 Material: alumínio

- Extremidade do cabo aberta



120W	21450lm	4000K
160W	28000lm	
200W	35000lm	

Versão	Art. n.º	EUR
● Preto	1008526	● 299,00



Artigo	Art. n.º	EUR
Caixa de ligação IP68 3 pinos		
● Preto	228730	18,00

### HIGHBAY C DALI 400

200W 840 IP65

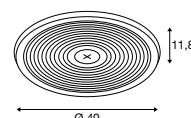

220-240V ~50/60Hz | 530/700/880mA  
 Potência do sistema: 200W  
 Material: alumínio

- Extremidade do cabo aberta



200W	35000lm   4000K
------	-----------------

Versão	Art. n.º	EUR
● Preto	1008527	● 349,00



Artigo	Art. n.º	EUR
Caixa de ligação IP68 5 pinos		
● Preto	228725	19,90



HIGBAY C  
Módulo CASAMBI

NEW



IP65

A: 2 cm  
Ø: 5,2 cm  
Material: policarbonato (PC)

Versão	Art. n.º	EUR
○ Branco	1008576	● 129,00

## HIGHBAY C 340

Refletor PC



NEW

A: 17,6 cm  
 Ø: 41,3 cm  
 Material: policarbonato (PC)

## HIGHBAY C 400

Refletor PC



NEW

A: 18,5 cm  
 Ø: 48 cm  
 Material: policarbonato (PC)

## HIGHBAY C

Arco de fixação em U



NEW

C: 25 cm  
 L: 4 cm  
 A: 3,3 cm  
 Material: aço

Versão	Art. n.º	EUR
<input type="radio"/> Transparente	1008529	69,00

Versão	Art. n.º	EUR
<input type="radio"/> Transparente	1008530	89,00

Versão	Art. n.º	EUR
<input type="radio"/> Prateado	1008528	14,50

## HIGHBAY C

Sensor HF



NEW



IP65

A: 2 cm  
 Ø: 5,2 cm  
 Material: plástico PC

## HIGHBAY C

Sensor PIR



NEW



IP65

A: 2,8 cm  
 Ø: 6,1 cm  
 Material: policarbonato (PC)

## HIGHBAY C

Telecomando



NEW



IP20

C: 14,7 cm  
 L: 6,9 cm  
 A: 2,5 cm  
 Material: policarbonato (PC)

Versão	Art. n.º	EUR
<input type="radio"/> Branco	1008531	49,00

Versão	Art. n.º	EUR
<input type="radio"/> Branco	1008532	49,00

Versão	Art. n.º	EUR
<input type="radio"/> Branco	1008575	49,00

HIGHBAY V 330  
100/120/170/200W 840 90° IP65

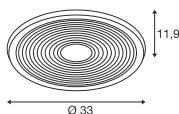

220-240V ~50/60Hz | 830mA  
Potência do sistema: 100/120/170/200W  
Material: alumínio

- Extremidade do cabo aberta



100W	17000lm	4000K
120W	20000lm	
170W	27000lm	
200W	32000lm	

Versão	Art. n.º	EUR
● Preto	1007679	● 235,00



Artigo	Art. n.º	EUR
Caixa de ligação IP68 3 pinos		
● Preto	228730	18,00



1007679 + 1007677 1024 + 1025



### HIGHBAY V 330

Arco de fixação 60°

NEW



C: 20,25 cm  
L: 4,96 cm  
A: 13,2 cm  
Material: aço

Versão	Art. n.º	EUR
● Preto	1007678	● 24,00

### HIGHBAY V 330

Conjunto de suspensão 1500

NEW



L: 1,92 cm  
A: 150 cm  
Material: aço

Versão	Art. n.º	EUR
● Aço inoxidável	1007676	● 24,00

### HIGHBAY V 330

Refletor 100°

NEW



Ø: 43,5 cm  
A: 13 cm  
Material: alumínio

Versão	Art. n.º	EUR
● Alumínio	1007677	● 50,00

1007515 1027





OUTDOOR BULKHEAD V 360  
20W 830/840 IP65 IK10

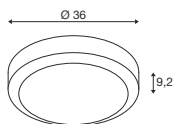

200-240V ~0/50/60Hz | 500mA  
Consumo de energia: 16,5W  
Potência do sistema: 20W  
Material: alumínio/policarbonato (PC)



1750lm | 3000K | 1850lm | 4000K | 1900lm | 6500K

Versão	Art. n.º	EUR
● Preto	1007514	● 85,00

OUTDOOR BULKHEAD V 360  
20W 830/840 IP65 IK10 S

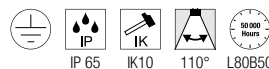
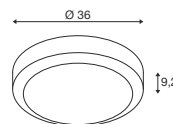

200-240V ~0/50/60Hz | 500mA  
Consumo de energia: 16,5W  
Potência do sistema: 20W  
Material: alumínio/policarbonato (PC)



1750lm | 3000K | 1850lm | 4000K | 1900lm | 6500K

Versão	Art. n.º	EUR
● Preto	1007515	● 110,00



1006193 1029



### FLOODI S SP

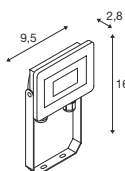

220-240V ~50/60Hz  
Potência do sistema: 9,3W  
Material: alumínio



Down 1040lm | 3000K

Versão	Art. n.º	EUR
● Antracite	1006191	30,00



Artigo	Art. n.º	EUR
Sensor		
● Preto	1006326	29,00

### FLOODI M SP

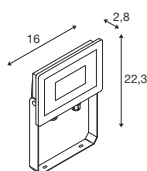

220-240V ~50/60Hz  
Potência do sistema: 30W  
Material: alumínio



Down 2980lm | 3000K

Versão	Art. n.º	EUR
● Antracite	1006192	45,00



Artigo	Art. n.º	EUR
Sensor		
● Preto	1006326	29,00

### FLOODI L SP

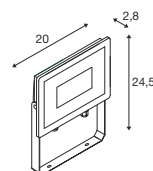

220-240V ~50/60Hz  
Potência total: 48W  
Material: alumínio



Down 5150lm | 3000K

Versão	Art. n.º	EUR
● Antracite	1006193	60,00



Artigo	Art. n.º	EUR
Sensor		
● Preto	1006326	29,00





## LED TUBE V T8 EM 1200 16W

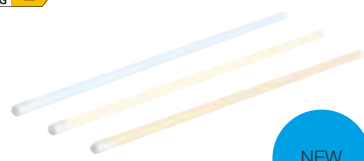

220-240V ~50/60Hz  
Potência: 16W  
Material: policarbonato (PC)/vidro  
Ø: 2,8 cm C: 121 cm  
Unidade embalada: 10 artigos

Fluxo luminoso	2000lm
Corrente da lâmpada	0.073A
Índice de reprodução cromática	80
Performance	16W
Consumo de energia/1000 h	16kWh

Versão	Art. n.º	EUR
○ Branco   3000K	<b>1008680</b>	● 90,00
○ Branco   4000K	<b>1008681</b>	● 90,00
○ Branco   6500K	<b>1008682</b>	● 90,00

## LED TUBE V T8 EM 1500 22W



220-240V ~50/60Hz  
Potência: 22W  
Material: policarbonato (PC)/vidro  
Ø: 2,8 cm C: 151 cm  
Unidade embalada: 10 artigos

Fluxo luminoso	2700lm
Corrente da lâmpada	0.102A
Índice de reprodução cromática	80
Performance	22W
Consumo de energia/1000 h	22kWh

Versão	Art. n.º	EUR
○ Branco   3000K	<b>1008683</b>	● 110,00
○ Branco   4000K	<b>1008684</b>	● 110,00
○ Branco   6500K	<b>1008685</b>	● 110,00

## LED TUBE C T8 EM 1200 16W



220-240V ~50/60Hz  
Potência: 16W  
Material: policarbonato (PC)/vidro  
Ø: 2,8 cm C: 121 cm  
Unidade embalada: 10 artigos

Fluxo luminoso	2400lm
Corrente da lâmpada	0.073A
Índice de reprodução cromática	80
Performance	16W
Consumo de energia/1000 h	16kWh

Versão	Art. n.º	EUR
○ Branco   3000K	<b>1008686</b>	● 140,00
○ Branco   4000K	<b>1008687</b>	● 140,00
○ Branco   6500K	<b>1008688</b>	● 140,00

## LED TUBE C T8 EM 1500 24W



220-240V ~50/60Hz  
Potência: 24W  
Material: policarbonato (PC)/vidro  
Ø: 2,8 cm C: 151 cm  
Unidade embalada: 10 artigos

Fluxo luminoso	3600lm
Corrente da lâmpada	0.108A
Índice de reprodução cromática	80
Performance	24W
Consumo de energia/1000 h	24kWh

Versão	Art. n.º	EUR
○ Branco   3000K	<b>1008689</b>	● 160,00
○ Branco   4000K	<b>1008690</b>	● 160,00
○ Branco   6500K	<b>1008691</b>	● 160,00

## LED TUBE C T5 EM 1200 26W



220-240V ~50/60Hz  
Potência: 26W  
Material: policarbonato (PC)/vidro  
Ø: 1,9 cm C: 116 cm  
Unidade embalada: 10 artigos

Fluxo luminoso	4100lm
Corrente da lâmpada	0.12A
Índice de reprodução cromática	80
Performance	26W
Consumo de energia/1000 h	26kWh

Versão	Art. n.º	EUR
○ Branco   3000K	<b>1008692</b>	● 350,00
○ Branco   4000K	<b>1008693</b>	● 350,00
○ Branco   6500K	<b>1008694</b>	● 350,00

## LED TUBE C T5 EM 1500 34W

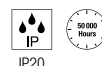

220-240V ~50/60Hz  
Potência: 34W  
Material: policarbonato (PC)/vidro  
Ø: 1,9 cm C: 146 cm  
Unidade embalada: 10 artigos

Fluxo luminoso	5100lm
Corrente da lâmpada	0.141A
Índice de reprodução cromática	80
Performance	34W
Consumo de energia/1000 h	34kWh

Versão	Art. n.º	EUR
○ Branco   3000K	<b>1008695</b>	● 420,00
○ Branco   4000K	<b>1008696</b>	● 420,00
○ Branco   6500K	<b>1008697</b>	● 420,00



1008163 1040





LED QT | 1034



LED CANDLE | 1034



LED G45 | 1034



LED C35 | 1034,1035



LED TCR-TSE | 1035



LED QR51 | 1035

LED A60 | 1035,  
1038, 1039, 1043

LED T32 | 1036



LED QPAR51 | 1036



LED | 1036

LED QPAR111  
| 1037, 1038

LED A19 | 1039

LED FLOATING  
GLOBE | 1040, 1041LED GLOBE  
| 1040, 1043LED TUBE SOFT  
SPIRAL | 1041LED SOFT  
TUBE | 1041

LED T38 | 1041



LED T45 | 1042



LED ST64 | 1042



LED TUBE | 1042

LED RUSTIKA  
SOFT CAGE | 1042

LED ST58 | 1042



LED G125 | 1043

## LED QT14 G9



NEW

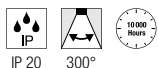

220-240V ~50/60Hz  
Potência: 3,6W  
Material: cerâmica  
Ø: 1,8 cm C: 5,4 cm

Fluxo luminoso	450lm
Corrente da lâmpada	0,033A
Índice de reprodução cromática	90
Performance	3,6W
Consumo de energia/1000 h	4kWh

Variante	Art. n.º	EUR
○ Branco		
2700K	1007455	8,80
○ Branco		
3000K	1005286	8,80

## LED CANDLE G9



NEW

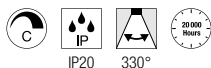

220-240V ~50/60Hz  
Material: vidro  
Ø: 3,5 cm C: 9,5 cm

Fabricante: Segula GmbH

Fluxo luminoso	260lm
Corrente da lâmpada	0,016A
Índice de reprodução cromática	90
Performance	3W
Consumo de energia/1000 h	3kWh

Variante	Art. n.º	EUR
○ Transparente		
2200K	1008158	34,00

## LED QT-DE12 R7S, 78 mm



220-240V ~50/60Hz  
Potência: 9W  
Material: policarbonato (PC)  
Ø: 2,9 cm C: 2,9 cm

Fluxo luminoso	1050lm
Corrente da lâmpada	0,043A
Índice de reprodução cromática	95
Performance	9W
Consumo de energia/1000 h	9kWh

Variante	Art. n.º	EUR
● Cinzento		
3000K	1005287	24,00

## LED QT-DE12 R7S, 118 mm

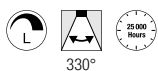

220-240V ~50/60Hz  
Potência: 15W  
Material: policarbonato (PC)  
Ø: 2,9 cm C: 2,9 cm

Fluxo luminoso	2000lm
Corrente da lâmpada	0.068A
Índice de reprodução cromática	92
Performance	15W
Consumo de energia/1000 h	15kWh

Variante	Art. n.º	EUR
● Cinzento		
3000K	1005288	28,50

## LED G45 E14 gold curly filament



NEW

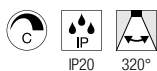

220-240V ~50/60Hz  
Potência: 2W  
Material: vidro  
Ø: 4,5 cm C: 7,5 cm

Corrente da lâmpada	10mA
Índice de reprodução cromática	>80
Performance	2W
Consumo de energia/1000 h	2kWh

Variante	Art. n.º	EUR
● Dourado fumado		
80lm   1800K	1008649	4,90
● Dourado fumado		
90lm   2200K	1008650	4,90

## LED C35 E14 gold curly filament



NEW



220-240V ~50/60Hz  
Potência: 2W  
Material: vidro  
Ø: 3,5 cm C: 9,8 cm

Corrente da lâmpada	10mA
Índice de reprodução cromática	>80
Performance	2W
Consumo de energia/1000 h	2kWh

Variante	Art. n.º	EUR
○ Transparente		
80lm   1800K	1008647	5,20
○ Transparente		
90lm   2200K	1008648	5,20

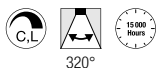
**LED C35**  
E14

220-240V ~50/60Hz  
Potência: 4,2W  
Material: vidro  
Ø: 3,5 cm C: 9,8 cm

Fluxo luminoso	380lm
Corrente da lâmpada	0.025A
Índice de reprodução cromática	90
Performance	4,2W
Consumo de energia/1000 h	5kWh

Variante	Art. n.º	EUR
<input type="radio"/> Transparente 2700K	<b>1005284</b>	<b>6,50</b>

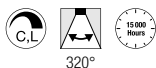
**LED C35**  
E14

220-240V ~50/60Hz  
Potência: 4,2W  
Material: vidro  
Ø: 3,5 cm C: 9,8 cm

Fluxo luminoso	350lm
Corrente da lâmpada	0.025A
Índice de reprodução cromática	90
Performance	4,2W
Consumo de energia/1000 h	5kWh

Variante	Art. n.º	EUR
<input type="radio"/> Branco 2700K	<b>1005285</b>	<b>8,50</b>

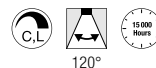
**LED TCR-TSE**  
GX53

220-240V ~50/60Hz  
Potência: 6,1W  
Material: policarbonato (PC)/  
policarbonato (PC)  
Ø: 7,5 cm C: 2,4 cm

Fluxo luminoso	490lm
Corrente da lâmpada	0.034A
Índice de reprodução cromática	93
Performance	6,1W
Consumo de energia/1000 h	6kWh

Variante	Art. n.º	EUR
<input type="radio"/> Branco 2700K	<b>1005272</b>	<b>11,50</b>
<input type="radio"/> Branco 3000K	<b>1005271</b>	<b>11,50</b>
<input type="radio"/> Branco 4000K	<b>1005269</b>	<b>11,50</b>

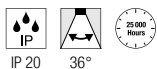
**LED QR51**  
GU5.3

12V AC  
Potência: 5,8W  
Material: vidro  
Ø: 5 cm C: 4,5 cm

Fabricante: Signify Netherlands B.V.

Fluxo luminoso	450lm
Corrente da lâmpada	0.63A
Intensidade máx. da luz	1300cd
Índice de reprodução cromática	90
Performance	5,8W
Consumo de energia/1000 h	6kWh

Variante	Art. n.º	EUR
<input type="radio"/> Transparente 2700K	<b>1001574</b>	<b>35,00</b>
<input type="radio"/> Transparente 3000K	<b>1001575</b>	<b>35,00</b>

**LED A60**  
GU10

NEW

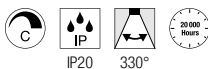

220-240V ~50/60Hz  
Material: vidro  
Ø: 6 cm C: 11 cm

Fabricante: Segula GmbH

Fluxo luminoso	400lm
Corrente da lâmpada	0.035A
Índice de reprodução cromática	90

Variante	Art. n.º	EUR
<input type="radio"/> Transparente 2200K	<b>1008154</b>	<b>44,00</b>

**LED A60**  
GU10

NEW

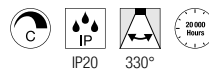

220-240V ~50/60Hz  
Material: vidro  
Ø: 6 cm C: 11 cm

Fabricante: Segula GmbH

Fluxo luminoso	650lm
Corrente da lâmpada	0.035A
Índice de reprodução cromática	90

Variante	Art. n.º	EUR
<input type="radio"/> Transparente 2200K	<b>1008375</b>	<b>44,00</b>

## LED T32 FILAMENT GU10 BULB GU10

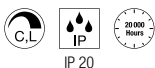

220-240V ~50/60Hz  
Potência: 3,2W  
Material: vidro  
Ø: 3,2 cm C: 10 cm

Fabricante: Segula GmbH

Fluxo luminoso	270lm
Corrente da lâmpada	0.0175A
Índice de reprodução cromática	90
Performance	3,2W

Variante	Art. n.º	EUR
○ Transparente 2700K	<b>1006321</b>	<b>39,00</b>

## LED QPAR51 GU10

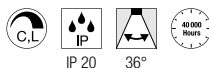

220-240V ~50/60Hz  
Potência: 6W  
Material: vidro  
Ø: 5 cm C: 5 cm

Fluxo luminoso	360lm
Corrente da lâmpada	0.033A
Intensidade máx. da luz	680cd
Índice de reprodução cromática	93
Performance	6W
Consumo de energia/1000 h	6kWh

Variante	Art. n.º	EUR
○ Prateado 2200-2700K	<b>1005273</b>	<b>9,99</b>

## LED QPAR51 GU10

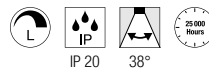

220-240V ~50/60Hz  
Potência: 6W  
Material: policarbonato (PC)  
Ø: 5 cm C: 5 cm

Fluxo luminoso	450lm
Corrente da lâmpada	0.037A
Intensidade máx. da luz	880cd
Índice de reprodução cromática	92
Performance	6W
Consumo de energia/1000 h	6kWh

Variante	Art. n.º	EUR
● Preto 2700K	<b>1005077</b>	<b>7,50</b>
● Preto 3000K	<b>1005080</b>	<b>7,50</b>
● Preto 4000K	<b>1005083</b>	<b>7,50</b>

## LED GU10

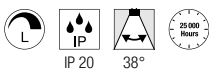

220-240V ~50/60Hz  
Potência: 6W  
Material: policarbonato (PC)  
Ø: 5 cm C: 5 cm

Fluxo luminoso	450lm
Corrente da lâmpada	0.037A
Intensidade máx. da luz	880cd
Índice de reprodução cromática	92
Performance	6W
Consumo de energia/1000 h	6kWh

Variante	Art. n.º	EUR
○ Branco 2700K	<b>1005076</b>	<b>7,50</b>
○ Branco 3000K	<b>1005079</b>	<b>7,50</b>
○ Branco 4000K	<b>1005082</b>	<b>7,50</b>

## LED QPAR51 GU10

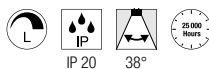

220-240V ~50/60Hz  
Potência: 6W  
Material: policarbonato (PC)  
Ø: 5 cm C: 5 cm

Fluxo luminoso	450lm
Corrente da lâmpada	0.037A
Intensidade máx. da luz	880cd
Índice de reprodução cromática	92
Performance	6W
Consumo de energia/1000 h	6kWh

Variante	Art. n.º	EUR
● Cinzento 2700K	<b>1005075</b>	<b>7,50</b>
● Cinzento 3000K	<b>1005078</b>	<b>7,50</b>
● Cinzento 4000K	<b>1005081</b>	<b>7,50</b>

## LED QPAR51 GU10

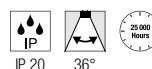

220-240V ~50/60Hz  
Potência: 2,4W  
Material: vidro  
Ø: 5 cm C: 5,4 cm

Fluxo luminoso	230lm
Corrente da lâmpada	0.025A
Intensidade máx. da luz	450cd
Índice de reprodução cromática	80
Performance	2,4W
Consumo de energia/1000 h	3kWh

Variante	Art. n.º	EUR
○ Transparente 2700K	<b>1007230</b>	<b>5,50</b>
○ Transparente 3000K	<b>1007231</b>	<b>5,50</b>

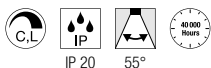
LED QPAR111  
GU10

220-240V ~50/60Hz  
Potência: 12W  
Material: alumínio  
Ø: 11 cm C: 7 cm

Fluxo luminoso	670lm
Corrente da lâmpada	0.05A
Intensidade máx. da luz	906cd
Índice de reprodução cromática	90
Performance	12W
Consumo de energia/1000 h	12kWh

Variante	Art. n.º	EUR
● Alumínio		
2700K	<b>1005297</b>	<b>85,00</b>
● Alumínio		
3000K	<b>1005298</b>	<b>85,00</b>
● Alumínio		
4000K	<b>1005299</b>	<b>85,00</b>

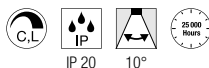
LED QPAR 111  
GU10

220-240V ~50/60Hz  
Potência: 12,5W  
Material: alumínio  
Ø: 11,1 cm C: 7 cm

Fluxo luminoso	900lm
Corrente da lâmpada	0.058A
Intensidade máx. da luz	11000cd
Índice de reprodução cromática	90
Performance	12,5W
Consumo de energia/1000 h	13kWh

Variante	Art. n.º	EUR
● Prateado		
2700K	<b>1005275</b>	<b>55,00</b>
● Prateado		
3000K	<b>1005278</b>	<b>55,00</b>
● Prateado		
4000K	<b>1005281</b>	<b>55,00</b>

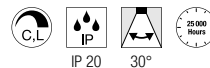
LED QPAR 111  
GU10

220-240V ~50/60Hz  
Potência: 12,5W  
Material: alumínio  
Ø: 11,1 cm C: 7 cm

Fluxo luminoso	950lm
Corrente da lâmpada	0.058A
Intensidade máx. da luz	3000cd
Índice de reprodução cromática	93
Performance	12,5W
Consumo de energia/1000 h	13kWh

Variante	Art. n.º	EUR
● Prateado		
2700K	<b>1005276</b>	<b>49,50</b>
● Prateado		
3000K	<b>1005279</b>	<b>49,50</b>
● Prateado		
4000K	<b>1005282</b>	<b>49,50</b>

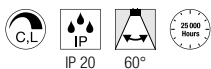
LED QPAR 111  
GU10

220-240V ~50/60Hz  
Potência: 12,5W  
Material: alumínio  
Ø: 11,1 cm C: 7 cm

Fluxo luminoso	1000lm
Corrente da lâmpada	0.058A
Intensidade máx. da luz	1000cd
Índice de reprodução cromática	93
Performance	12,5W
Consumo de energia/1000 h	13kWh

Variante	Art. n.º	EUR
● Prateado		
2700K	<b>1005277</b>	<b>49,50</b>
● Prateado		
3000K	<b>1005280</b>	<b>49,50</b>
● Prateado		
4000K	<b>1005283</b>	<b>49,50</b>

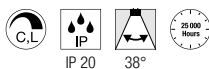
LED QPAR111  
GU10

220-240V ~50/60Hz  
Potência: 8W  
Material: vidro  
Ø: 11,1 cm C: 6,1 cm

Fluxo luminoso	680lm
Corrente da lâmpada	0.046A
Intensidade máx. da luz	1300cd
Índice de reprodução cromática	93
Performance	8W
Consumo de energia/1000 h	8kWh

Variante	Art. n.º	EUR
● Transparente		
2700K	<b>1005274</b>	<b>29,00</b>

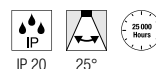
LED QPAR111  
GU10

220-240V ~50/60Hz  
Potência: 7,3W  
Material: plástico/alumínio  
Ø: 11,1 cm C: 7,1 cm

Fluxo luminoso	530lm
Corrente da lâmpada	0.051A
Intensidade máx. da luz	1400cd
Índice de reprodução cromática	93
Performance	7,3W
Consumo de energia/1000 h	8kWh

Variante	Art. n.º	EUR
● Prateado		
2700K	<b>1005291</b>	<b>24,50</b>
● Prateado		
3000K	<b>1005292</b>	<b>24,50</b>

## LED QPAR111 GU10

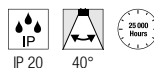

220-240V ~50/60Hz  
Potência: 7,3W  
Material: plástico/alumínio  
Ø: 11,1 cm C: 7,1 cm

Fluxo luminoso	500lm
Corrente da lâmpada	0,051A
Intensidade máx. da luz	1000cd
Índice de reprodução cromática	93
Performance	7,3W
Consumo de energia/1000 h	8kWh

Variante	Art. n.º	EUR
● Prateado 2700K	<b>1005294</b>	<b>24,50</b>
● Prateado 3000K	<b>1005295</b>	<b>24,50</b>
● Prateado 4000K	<b>1005296</b>	<b>24,50</b>

## LED A60 E27, tunable 2700-6500K, smart

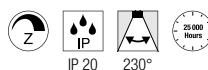

220-240V ~50/60Hz  
Potência: 9W  
Material: poliamida 66 (PA 66)  
Ø: 6 cm C: 11 cm

Fluxo luminoso	800lm
Corrente da lâmpada	0,067A
Índice de reprodução cromática	92
Performance	9W
Consumo de energia/1000 h	9kWh

Variante	Art. n.º	EUR
● Branco 2700-6500K	<b>1005317</b>	<b>32,00</b>

1002168 1039



### LED A60 E27, RGBW, smart

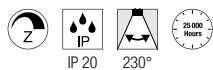

220-240V ~50/60Hz  
Potência: 9W  
Material: poliamida 66 (PA 66)/  
policarbonato (PC)  
Ø: 6 cm C: 11 cm

Fluxo luminoso	800lm
Corrente da lâmpada	0.073A
Índice de reprodução cromática	92
Performance	9W
Consumo de energia/1000 h	9kWh

Variante	Art. n.º	EUR
○ Branco	1005318	44,50

### LED A19 SOFT CAGE E27

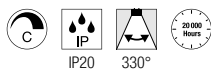

220-240V ~50/60Hz  
Material: vidro  
Ø: 6 cm C: 11 cm

Fabricante: Segula GmbH

Fluxo luminoso	570lm
Corrente da lâmpada	0.034A
Índice de reprodução cromática	90
Performance	6W

Variante	Art. n.º	EUR
○ Transparente		
2200K	1008153	54,00

### LED A60 E27

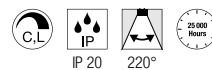

220-240V ~50/60Hz  
Potência: 13,2W  
Material: plástico  
Ø: 6 cm C: 12 cm

Fluxo luminoso	1300lm
Corrente da lâmpada	0.062A
Índice de reprodução cromática	93
Performance	13,2W
Consumo de energia/1000 h	13kWh

Variante	Art. n.º	EUR
○ Branco		
2700K	1005302	12,25

### LED A60 E27 clear filament high efficiency

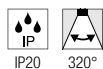

220-240V ~50/60Hz  
Potência: 3,8W  
Material: vidro  
Ø: 6 cm C: 10,8 cm

Fluxo luminoso	806lm
Corrente da lâmpada	37mA
Intensidade máx. da luz	840lm
Índice de reprodução cromática	>80
Performance	3.8W
Consumo de energia/1000 h	4kWh

Variante	Art. n.º	EUR
○ Transparente		
2700K	1008641	7,50
○ Transparente		
3000K	1008642	7,50

### LED A60 E27 clear filament

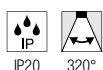

220-240V ~50/60Hz  
Potência: 7W  
Material: vidro  
Ø: 6 cm C: 10,8 cm

Fluxo luminoso	806lm
Corrente da lâmpada	46mA
Intensidade máx. da luz	810lm
Índice de reprodução cromática	>80
Performance	7W
Consumo de energia/1000 h	7kWh

Variante	Art. n.º	EUR
○ Transparente		
2700K	1008643	3,20
○ Transparente		
3000K	1008644	3,20

### LED A60 E27



220-240V ~50/60Hz  
Potência: 7,5W  
Material: vidro  
Ø: 6 cm C: 10,5 cm

Fluxo luminoso	800lm
Corrente da lâmpada	0.038A
Índice de reprodução cromática	93
Performance	7,5W
Consumo de energia/1000 h	8kWh

Variante	Art. n.º	EUR
○ Transparente		
2700K	1005303	9,60

## LED FLOATING GLOBE 150

twisted smokey grey, E27



NEW



220-240V ~50/60Hz  
Material: vidro  
Ø: 15 cm C: 18,5 cm

Devido à temperatura de cor de 1900 K, esta lâmpada é um objeto decorativo e não necessita de etiqueta energética.

Fabricante: Segula GmbH

Fluxo luminoso	230lm
Corrente da lâmpada	0.035A
Índice de reprodução cromática	85
Performance	6W
Consumo de energia/1000 h	6kWh

Variante	Art. n.º	EUR
● Cinzento fumado 1900K	<b>1008151</b>	<b>84,00</b>

## LED GLOBE 125

Illusion, two Crescent, E27



NEW



220-240V ~50/60Hz  
Material: vidro  
Ø: 12,5 cm C: 18 cm

Devido à temperatura de cor de 1900 K, esta lâmpada é um objeto decorativo e não necessita de etiqueta energética.

Fabricante: Segula GmbH

Fluxo luminoso	400lm
Corrente da lâmpada	0.04A
Índice de reprodução cromática	90
Performance	8W
Consumo de energia/1000 h	8kWh

Variante	Art. n.º	EUR
● Cinzento fumado 1900K	<b>1008159</b>	<b>89,00</b>

## LED GLOBE 125

Illusion, slanting top, E27



NEW

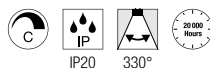

220-240V ~50/60Hz  
Material: vidro  
Ø: 12,5 cm C: 18 cm

Fabricante: Segula GmbH

Fluxo luminoso	350lm
Corrente da lâmpada	0.035A
Índice de reprodução cromática	90
Performance	5W
Consumo de energia/1000 h	5kWh

Variante	Art. n.º	EUR
● Cinzento fumado 2200K	<b>1008160</b>	<b>79,00</b>

## LED GLOBE 125

Illusion, crescent slanting, E27



NEW

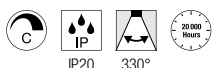

220-240V ~50/60Hz  
Material: vidro  
Ø: 12,5 cm C: 18 cm

Devido à temperatura de cor de 1900K, esta lâmpada é um objeto decorativo e não necessita de etiqueta energética.

Fabricante: Segula GmbH

Fluxo luminoso	310lm
Corrente da lâmpada	0.03A
Índice de reprodução cromática	90
Performance	6W
Consumo de energia/1000 h	6kWh

Variante	Art. n.º	EUR
● Cinzento fumado 1900K	<b>1008161</b>	<b>69,00</b>

## LED FLOATING GLOBE 125

E27



NEW

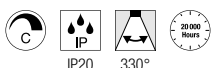

220-240V ~50/60Hz  
Material: vidro  
Ø: 12,5 cm C: 16,5 cm

Devido à temperatura de cor de 1900K, esta lâmpada é um objeto decorativo e não necessita de etiqueta energética.

Fabricante: Segula GmbH

Fluxo luminoso	220lm
Corrente da lâmpada	0.035A
Índice de reprodução cromática	85
Performance	6W
Consumo de energia/1000 h	6kWh

Variante	Art. n.º	EUR
● Cinzento fumado 1900K	<b>1008155</b>	<b>69,00</b>

## LED FLOATING GLOBE 150

E27



NEW

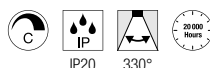

220-240V ~50/60Hz  
Material: vidro  
Ø: 15 cm C: 18,5 cm

Devido à temperatura de cor de 1900K, esta lâmpada é um objeto decorativo e não necessita de etiqueta energética.

Fabricante: Segula GmbH

Fluxo luminoso	260lm
Corrente da lâmpada	0.035A
Índice de reprodução cromática	85
Performance	6W
Consumo de energia/1000 h	6kWh

Variante	Art. n.º	EUR
● Cinzento fumado 2200K	<b>1008163</b>	<b>84,00</b>





## LED FLOATING GLOBE 200 E27



NEW

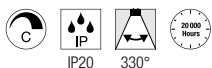

220-240V ~50/60Hz  
Material: vidro  
Ø: 20 cm C: 23 cm

Devido à temperatura de cor de 1900K, esta lâmpada é um objeto decorativo e não necessita de etiqueta energética.

Fabricante: Segula GmbH

Fluxo luminoso	220lm
Corrente da lâmpada	0.035A
Índice de reprodução cromática	85
Performance	6W
Consumo de energia/1000 h	6kWh

Variante	Art. n.º	EUR
● Cinzento fumado		
1900K	<b>1008164</b>	<b>104,00</b>

## LED FLOATING GLOBE 300 E27



NEW

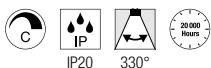

220-240V ~50/60Hz  
Material: vidro  
Ø: 30 cm C: 32 cm

Devido à temperatura de cor de 1900K, esta lâmpada é um objeto decorativo e não necessita de etiqueta energética.

Fabricante: Segula GmbH

Fluxo luminoso	300lm
Corrente da lâmpada	0.045A
Índice de reprodução cromática	85
Performance	6W
Consumo de energia/1000 h	6kWh

Variante	Art. n.º	EUR
● Cinzento fumado		
1900K	<b>1008165</b>	<b>249,00</b>

## LED BULB SOFT CAGE A19 E27



NEW

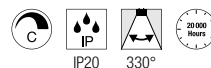

220-240V ~50/60Hz  
Material: vidro  
Ø: 6 cm C: 11 cm

Devido à temperatura de cor de 1900K, esta lâmpada é um objeto decorativo e não necessita de etiqueta energética.

Fabricante: Segula GmbH

Corrente da lâmpada	0.035A
Índice de reprodução cromática	90

Variante	Art. n.º	EUR
● Cinzento fumado		
1900K	<b>1008153</b>	<b>54,00</b>

## LED TUBE SOFT SPIRAL E27



NEW

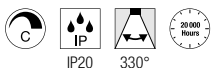

220-240V ~50/60Hz  
Material: vidro  
Ø: 3,2 cm C: 19 cm

Fabricante: Segula GmbH

Fluxo luminoso	570lm
Corrente da lâmpada	0.035A
Índice de reprodução cromática	90
Performance	6W
Consumo de energia/1000 h	6kWh

Variante	Art. n.º	EUR
○ Transparente		
2200K	<b>1008152</b>	<b>64,00</b>

## LED SOFT TUBE T300 E27



NEW

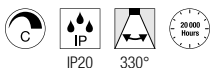

220-240V ~50/60Hz  
Material: vidro  
Ø: 3,2 cm C: 30 cm

Devido à temperatura de cor de 1900 K, esta lâmpada é um objeto decorativo e não necessita de etiqueta energética.

Fabricante: Segula GmbH

Fluxo luminoso	400lm
Corrente da lâmpada	0.045A
Índice de reprodução cromática	90
Performance	8W
Consumo de energia/1000 h	8kWh

Variante	Art. n.º	EUR
○ Transparente		
1900K	<b>1008374</b>	<b>49,00</b>

## LED T38 E27

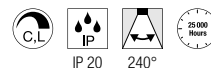

220-240V ~50/60Hz  
Potência: 8W  
Material: plástico  
Ø: 3,8 cm C: 11,6 cm

Devido à temperatura de cor de 1900 K, esta lâmpada é um objeto decorativo e não necessita de etiqueta energética.

Fabricante: Segula GmbH

Fluxo luminoso	880lm
Corrente da lâmpada	0.035A
Índice de reprodução cromática	94
Performance	8W
Consumo de energia/1000 h	8kWh

Variante	Art. n.º	EUR
○ Branco		
3000K	<b>1005289</b>	<b>10,25</b>
○ Branco		
4000K	<b>1005290</b>	<b>10,25</b>

## LED T45 E27

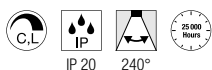

220-240V ~50/60Hz  
Potência: 13,5W  
Material: plástico  
Ø: 4,5 cm C: 14 cm

Fluxo luminoso	1520lm
Corrente da lâmpada	0.06A
Índice de reprodução cromática	94
Performance	13,5W
Consumo de energia/1000 h	14kWh

Variante	Art. n.º	EUR
<input type="radio"/> Branco		
3000K	<b>1005307</b>	<b>12,50</b>
<input type="radio"/> Branco		
4000K	<b>1005308</b>	<b>12,50</b>

## LED TUBE High Brightness, E27

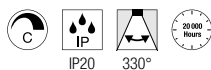

220-240V ~50/60Hz  
Potência: 11W  
Material: vidro  
Ø: 3,2 cm C: 17,5 cm

Fabricante: Segula GmbH

Fluxo luminoso	1250lm
Corrente da lâmpada	0.06A
Índice de reprodução cromática	90
Performance	11W
Consumo de energia/1000 h	11kWh

Variante	Art. n.º	EUR
<input type="radio"/> Transparente		
2700K	<b>1008162</b>	<b>84,00</b>

## LED ST64 E27



220-240V ~50/60Hz  
Potência: 7,5W  
Material: vidro  
Ø: 6,4 cm C: 14,5 cm

Fluxo luminoso	700lm
Corrente da lâmpada	0.038A
Índice de reprodução cromática	90
Performance	7,5W
Consumo de energia/1000 h	8kWh

Variante	Art. n.º	EUR
<input checked="" type="radio"/> Dourado		
2500K	<b>1005265</b>	<b>26,50</b>

## LED RUSTIKA SOFT CAGE E27

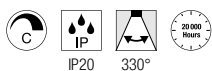

220-240V ~50/60Hz  
Material: vidro  
Ø: 6,5 cm C: 14,5 cm

Fabricante: Segula GmbH

Fluxo luminoso	570lm
Corrente da lâmpada	0.034A
Índice de reprodução cromática	90
Performance	6W
Consumo de energia/1000 h	6kWh

Variante	Art. n.º	EUR
<input type="radio"/> Transparente	<b>1008156</b>	<b>54,00</b>

## LED ST64 E27 gold curly filament

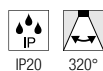

220-240V ~50/60Hz  
Potência: 2W  
Material: vidro  
Ø: 6,4 cm C: 14,2 cm

Fluxo luminoso	300lm
Corrente da lâmpada	34mA
Índice de reprodução cromática	>80
Performance	4W
Consumo de energia/1000 h	4kWh

Variante	Art. n.º	EUR
<input checked="" type="radio"/> Dourado fumado		
260lm   1800K	<b>1008645</b>	<b>5,90</b>
<input checked="" type="radio"/> Dourado fumado		
300lm   2200K	<b>1008646</b>	<b>5,90</b>

## LED ST58 E27



220-240V ~50/60Hz  
Potência: 7,5W  
Material: vidro  
Ø: 5,8 cm C: 14,2 cm

Fluxo luminoso	800lm
Corrente da lâmpada	0.038A
Índice de reprodução cromática	93
Performance	7,5W
Consumo de energia/1000 h	8kWh

Variante	Art. n.º	EUR
<input type="radio"/> Transparente		
2700K	<b>1005268</b>	<b>12,25</b>



### LED A60 E27, Mirrorhead, Chrom

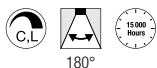

220-240V ~50/60Hz  
Potência: 7,5W  
Material: vidro  
Ø: 6 cm C: 10,5 cm

Fluxo luminoso	720lm
Corrente da lâmpada	0.038A
Índice de reprodução cromática	92
Performance	7,5W
Consumo de energia/1000 h	8kWh

Variante	Art. n.º	EUR
<input checked="" type="radio"/> Cromado 2700K	1005305	19,00

### LED G125 E27

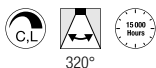

220-240V ~50/60Hz  
Potência: 7,5W  
Material: vidro  
Ø: 12,5 cm C: 17,8 cm

Fluxo luminoso	800lm
Corrente da lâmpada	0.038A
Índice de reprodução cromática	93
Performance	7,5W
Consumo de energia/1000 h	8kWh

Variante	Art. n.º	EUR
<input type="radio"/> Transparente 2700K	1005310	18,50

### LED GLOBE 125 Half Moon frosted, E27

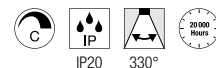

220-240V ~50/60Hz  
Material: vidro  
Ø: 12,5 cm C: 18 cm

Fabricante: Segula GmbH

Fluxo luminoso	650lm
Corrente da lâmpada	0.035A
Índice de reprodução cromática	90
Performance	6,5W
Consumo de energia/1000 h	7kWh

Variante	Art. n.º	EUR
<input type="radio"/> Fosco 2700K	1008157	49,00



1005310 1043

132690 + 132670    299 + 1057





TRANSFORMADOR  
ELETRÔNICO | 1046



TRANSFORMADOR  
TENSEO | 1046



INTERFACE  
DALI | 1046



CONVERSOR | 1046



CONVERSOR DALI  
UNIVERSAL | 1046



DRIVER DALI | 1047



DRIVER ZIGBEE | 1047



TRANSFORMADOR  
LED | 1047, 1048,  
1049



TRANSFORMADOR  
LED REGULÁVEL |  
1049, 1050



DRIVER LED | 1050,  
1051, 1052, 1053,  
1054



ACESSÓRIO PARA  
DRIVER | 1054



DRIVER LED  
REGULÁVEL | 1055



MÓDULO ZIGBEE  
PARA DRIVER  
DALI | 1056



MÓDULO CASAMBI  
PARA DRIVER  
DALI | 1056



DRIVER DT8 | 1056



TELECOMANDO  
SMART | 1056



KIT DE  
EMERGÊNCIA | 1056



GANCHO PARA  
TETO | 1057



BRAÇADEIRA  
DE CABOS | 1057



GLENOS® | 1057



CABO EM  
TECIDO | 1057



GU10 LED CONNec-  
TION BOX | 1057



GU10 CONNECTION  
BOX | 1057

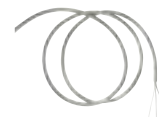

CABO | 1058



CASQUILHO  
GU10 | 1058



LIGADOR  
ESTANQUE | 1058



CONNECTION  
BOX T | 1058



CONNECTION  
BOX Y | 1058

## TRANSF. ELETRÓNICO 60W | 12V regulável

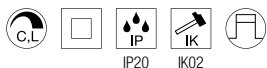
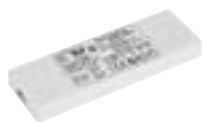

220-240V ~50/60Hz  
C: 10,6 cm L: 3,3 cm A: 2,2 cm

Tensão de saída	11.2V-11.5V
Potência de	3W
Potência até	60W
Proteção térmica	110°C
Número de saídas secundárias	1

Variante	Art. n.º	EUR
○ Branco	1008675	28,00

## TRANSF. TENSEO 12V AC | 50VA convencional

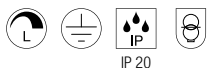

220-240V ~50/60Hz  
A: 11 cm Ø: 11,1 cm  
Material: aço/latão

Tensão de saída	12V AC
Potência até	60W
Proteção térmica	130°C
Número de saídas secundárias	1

Variante	Art. n.º	EUR
● Preto	1002691	111,00
○ Branco	1002692	111,00
● Cromado	1002693	115,00

## TRANS. TENSEO 12V AC | 105VA convencional



220-240V ~50/60Hz  
A: 11 cm Ø: 11,1 cm  
Material: bronze/vidro

Tensão de saída	12V AC
Potência até	105W
Proteção térmica	130°C
Número de saídas secundárias	1

Variante	Art. n.º	EUR
○ Branco	138981	135,00
● Cromado	138982	147,00

## TRANSF. TENSEO 12V AC | 210VA convencional

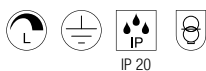

220-240V ~50/60Hz  
A: 11 cm Ø: 13,5 cm  
Material: aço/latão

Tensão de saída	12V AC
Potência até	210W
Proteção térmica	130°C
Número de saídas secundárias	1

Variante	Art. n.º	EUR
○ Branco	138991	204,00
● Cromado	138992	213,00

## CONVERSOR DALI – 1-10V 1-10V + on/off



C: 5,85 cm L: 3,25 cm A: 1,5 cm  
Material: plástico

- Para controlar balastros elétricos com entrada de controlo de 1-10 V
- Isolamento galvânico da entrada DALI e saída de 1-10 V

Tensão de saída	250V AC
Potência até	1000W

Variante	Art. n.º	EUR
● Cinzento	1002218	269,00

## CONVERSOR DALI – FASE Regulação de fase



100-240V ~50/60Hz  
C: 4,6 cm L: 4,5 cm A: 2 cm  
Material: policarbonato (PC)

- Conversor de protocolo DALI e Push em controlo por corte de fase.

Tensão de saída	100-240
Potência de	0W
Potência até	200W

Variante	Art. n.º	EUR
○ Branco	1006452	79,00



## CONVERSOR UNIV. DALI > FASE 10-300W



C: 12,02 cm L: 3,02 cm A: 2,16 cm  
Material: plástico

- Adequado para carga R, L, C, graças à deteção automática de carga. Consumo de corrente DALI: 6 mA

Tensão de saída	230V AC
Potência de	10W
Potência até	300W

Variante	Art. n.º	EUR
● Cinzento	1002221	359,00

## DRIVER DALI 24V DC

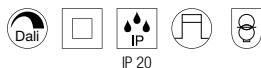

10V-24V DC  
C: 11,6 cm L: 4,2 cm A: 1,8 cm  
Material: policarbonato (PC)

- Fita LED Push-dim de 1 canal e controlo DALI

Tensão de saída	10-24V DC
Número de saídas secundárias	1

Variante	Art. n.º	EUR
● Branco/Cinzento	1003106	64,00

## DRIVER ZIGBEE LED Stip CCT / RGBW



12V/24V CC  
C: 14,5 cm L: 4,65 cm A: 1,6 cm  
Material: policarbonato (PC)

- Controlo de luminosidade para fitas LED de uma só cor
- Controlo da temperatura da cor para fitas CCT
- Controlo total da cor das fitas RGB+CCT
- Controlável através do protocolo de rádio Zigbee

Tensão de saída	12-24V DC
Potência de	48W
Potência até	96W
Proteção térmica	100°C

Variante	Art. n.º	EUR
○ Branco	1006348	80,00

## TRANSFORMADOR LED 24V | 24W



NEW



220-240V ~50/60Hz  
C: 13,7 cm L: 5 cm A: 1,55 cm

Tensão de saída	24 0
Potência de	0W
Potência até	24W
Número de saídas secundárias	1

Variante	Art. n.º	EUR
○ Branco	1008653	40,00

## TRANSFORMADOR LED 24V | 36W

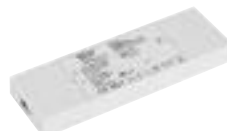

NEW

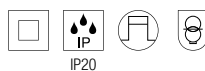

220-240V ~50/60Hz  
C: 17 cm L: 5,7 cm A: 1,8 cm

Tensão de saída	24 0
Potência de	0W
Potência até	36W
Número de saídas secundárias	1

Variante	Art. n.º	EUR
○ Branco	1008654	55,00

## TRANSFORMADOR LED 24V | 60W

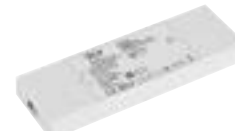

NEW

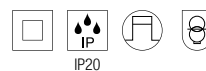

220-240V ~50/60Hz  
C: 17 cm L: 5,7 cm A: 1,8 cm

Tensão de saída	24 0
Potência de	0W
Potência até	60W
Número de saídas secundárias	1

Variante	Art. n.º	EUR
○ Branco	1008655	65,00

### TRANSFORMADOR LED 12V | 24W, Redondo

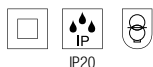

220-240V ~50/60Hz  
A: 2,5 cm Ø: 5,5 cm

Tensão de saída	12 0
Potência de	1,2W
Potência até	24W
Número de saídas secundárias	1

Variante	Art. n.º	EUR
<input type="radio"/> Branco	1008651	27,00

### TRANSFORMADOR LED 24V | 25W, Redondo

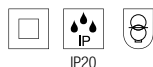

220-240V ~50/60Hz  
A: 2,5 cm Ø: 5,5 cm

Tensão de saída	24 0
Potência de	1,2W
Potência até	25W
Número de saídas secundárias	1

Variante	Art. n.º	EUR
<input type="radio"/> Branco	1008652	27,00

### TRANSFORMADOR LED 30W | 24V DC Incl. alívio de tensão

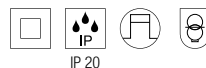

220-240V ~50/60Hz  
C: 30 cm L: 3 cm A: 1,6 cm  
Material: policarbonato (PC)

Tensão de saída	24V DC
Potência de	0W
Potência até	30W
Fator de potência do aparelho de serviço	0.95
Proteção térmica	110°C
Número de saídas secundárias	1

Variante	Art. n.º	EUR
<input type="radio"/> Branco	1007250	50,00

### TRANSFORMADOR LED 100W | 24V DC Incl. alívio de tensão



220-240V ~50/60Hz  
C: 35 cm L: 3 cm A: 1,8 cm  
Material: policarbonato (PC)

Tensão de saída	24V DC
Potência de	0W
Potência até	100W
Fator de potência do aparelho de serviço	0.95
Proteção térmica	110°C
Número de saídas secundárias	1

Variante	Art. n.º	EUR
<input type="radio"/> Branco	1007251	80,00

### TRANSFORMADOR LED 150W | 24V DC Incl. alívio de tensão

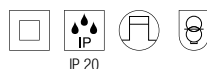

220-240V ~50/60Hz  
C: 35 cm L: 3 cm A: 1,8 cm  
Material: policarbonato (PC)

Tensão de saída	24V DC
Potência de	0W
Potência até	150W
Fator de potência do aparelho de serviço	0.95
Proteção térmica	110°C
Número de saídas secundárias	1

Variante	Art. n.º	EUR
<input type="radio"/> Branco	1007252	100,00

### TRANSFORMADOR LED 250W | 24V DC Incl. alívio de tensão

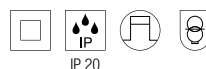

220-240V ~50/60Hz  
C: 40 cm L: 4 cm A: 2,2 cm  
Material: policarbonato (PC)

Tensão de saída	24V DC
Potência de	0W
Potência até	250W
Fator de potência do aparelho de serviço	0.95
Proteção térmica	110°C
Número de saídas secundárias	1

Variante	Art. n.º	EUR
<input type="radio"/> Branco	1007253	120,00

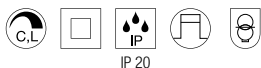

**TRANSFORMADOR LED**  
25W | 24V

220-240V ~50/60Hz  
C: 12,8 cm L: 5,2 cm A: 3 cm  
Material: policarbonato (PC)/policarbonato (PC)

Tensão de saída	24V/DC
Potência de	9.6W
Potência até	25W
Fator de potência do aparelho de serviço	0.95
Proteção térmica	110°C
Número de saídas secundárias	1

Variante	Art. n.º	EUR
<input type="radio"/> Branco/Azul	<b>1006336</b>	<b>35,00</b>

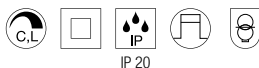
**TRANSFORMADOR LED**  
50W | 24V

220-240V ~50/60Hz  
C: 18,4 cm L: 6,1 cm A: 3,2 cm  
Material: policarbonato (PC)/policarbonato (PC)

Tensão de saída	24V DC
Potência de	12W
Potência até	50W
Fator de potência do aparelho de serviço	0.95
Proteção térmica	110°C
Número de saídas secundárias	1

Variante	Art. n.º	EUR
<input type="radio"/> Branco/Azul	<b>1003104</b>	<b>49,50</b>

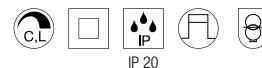
**TRANSFORMADOR LED**  
100W | 24V DC

220-240V ~50/60Hz  
C: 21 cm L: 6,7 cm A: 3,4 cm  
Material: policarbonato (PC)/policarbonato (PC)

Tensão de saída	24V DC
Potência de	33W
Potência até	100W
Fator de potência do aparelho de serviço	0.95
Proteção térmica	110°C
Número de saídas secundárias	1

Variante	Art. n.º	EUR
<input type="radio"/> Branco/Azul	<b>1003105</b>	<b>121,00</b>

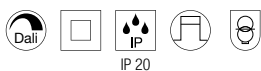
**TRANSFORMADOR LED**  
30W | 24V DC DALI regulável  
incl. alívio de tensão

220-240V ~50/60Hz  
C: 30 cm L: 3 cm A: 1,6 cm  
Material: policarbonato (PC)

Tensão de saída	24V DC
Potência de	12W
Potência até	30W
Fator de potência do aparelho de serviço	0.95
Proteção térmica	110°C
Número de saídas secundárias	1

Variante	Art. n.º	EUR
<input type="radio"/> Branco	<b>1007254</b>	<b>60,00</b>

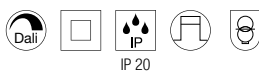
**TRANSFORMADOR LED**  
100W | 24V DC DALI regulável  
incl. alívio de tensão

220-240V ~50/60Hz  
C: 35 cm L: 3 cm A: 1,8 cm  
Material: policarbonato (PC)

Tensão de saída	24V DC
Potência de	30W
Potência até	100W
Fator de potência do aparelho de serviço	0.95
Proteção térmica	110°C
Número de saídas secundárias	1

Variante	Art. n.º	EUR
<input type="radio"/> Branco	<b>1007255</b>	<b>110,00</b>

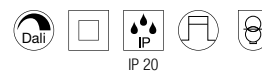
**TRANSFORMADOR LED**  
150W | 24V DC DALI regulável  
incl. alívio de tensão

220-240V ~50/60Hz  
C: 35 cm L: 3 cm A: 1,8 cm  
Material: policarbonato (PC)

Tensão de saída	24V DC
Potência de	45W
Potência até	150W
Fator de potência do aparelho de serviço	0.95
Proteção térmica	110°C
Número de saídas secundárias	1

Variante	Art. n.º	EUR
<input type="radio"/> Branco	<b>1007256</b>	<b>140,00</b>

**TRANSFORMADOR LED**  
250W | 24V DC DALI regulável  
incl. alívio de tensão

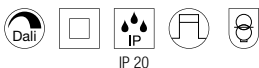

220-240V ~50/60Hz  
C: 40 cm L: 4 cm A: 2,2 cm  
Material: policarbonato (PC)

Tensão de saída	24V DC
Potência de	75W
Potência até	250W
Fator de potência do aparelho de serviço	0,95
Proteção térmica	110°C
Número de saídas secundárias	1

Variante	Art. n.º	EUR
<input type="radio"/> Branco	<b>1007257</b>	<b>160,00</b>

**TRANSFORMADOR LED**  
60W | DALI, 24V, 2 canais DALI regulável

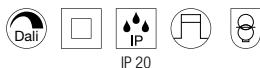

220-240V ~50/60Hz  
C: 20,2 cm L: 5,8 cm A: 3 cm  
Material: policarbonato (PC)

Tensão de saída	24V DC
Potência de	5W
Potência até	60W
Fator de potência do aparelho de serviço	0,95
Proteção térmica	110°C
Número de saídas secundárias	2

Variante	Art. n.º	EUR
<input type="radio"/> Branco	<b>1006133</b>	<b>153,00</b>

**TRANSFORMADOR LED**  
100W | 24V | 2 canais DALI regulável

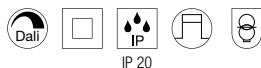

220-240V ~50/60Hz  
C: 34,7 cm L: 4 cm A: 2,2 cm  
Material: policarbonato (PC)

Tensão de saída	24V DC
Potência de	5W
Potência até	100W
Fator de potência do aparelho de serviço	0,95
Proteção térmica	110°C
Número de saídas secundárias	2

Variante	Art. n.º	EUR
<input type="radio"/> Branco	<b>1006134</b>	<b>184,00</b>

**DRIVER LED**  
4W | 350mA

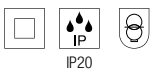

220-240V ~50/60Hz  
C: 4,75 cm L: 2,72 cm A: 2 cm  
Material: plástico PC

Tensão de saída	2.7V-9.5V
Potência de	1W
Potência até	3,32W
Número de saídas secundárias	1

Variante	Art. n.º	EUR
<input type="radio"/> Branco	<b>1008656</b>	<b>19,00</b>

**DRIVER LED**  
4W | 700mA

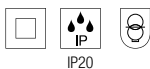

220-240V ~50/60Hz  
C: 4,75 cm L: 2,72 cm A: 2 cm  
Material: plástico PC

Tensão de saída	2.7V-4.5V
Potência de	1,9W
Potência até	3,15W
Número de saídas secundárias	1

Variante	Art. n.º	EUR
<input type="radio"/> Branco	<b>1008657</b>	<b>19,00</b>

**DRIVER LED**  
10W | 350mA Redondo

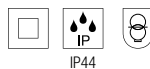

220-240V ~50/60Hz  
A: 202 cm Ø: 4,23 cm  
Material: plástico PC

Tensão de saída	19V-29V
Potência de	6,65W
Potência até	10,15W
Número de saídas secundárias	1

Variante	Art. n.º	EUR
<input type="radio"/> Branco	<b>1008658</b>	<b>29,00</b>

**DRIVER LED**  
15W | 700mA Redondo

NEW



IP44

220-240V ~50/60Hz  
A: 2,1 cm Ø: 5 cm  
Material: plástico PC

Tensão de saída	13 21
Potência de	9,1W
Potência até	14,7W
Número de saídas secundárias	1

Variante	Art. n.º	EUR
<input type="radio"/> Branco	1008659	29,00

**DRIVER LED**  
20W | 350mA

IP 20 IK03

220-240V 0/~50/60Hz  
C: 11,6 cm L: 4,1 cm A: 2,5 cm  
Material: policarbonato (PC)

Tensão de saída	2-54V DC
Potência de	0.7W
Potência até	19W
Fator de potência do aparelho de serviço	0.95
Proteção térmica	110°C
Número de saídas secundárias	1

Variante	Art. n.º	EUR
<input type="radio"/> Branco	1007225	30,00

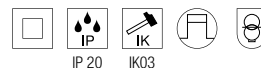
**DRIVER LED**  
21W | 500mA Incl. alívio de tensão

IP 20 IK03

220-240V 0/~50/60Hz  
C: 11,6 cm L: 4,1 cm A: 2,5 cm  
Material: policarbonato (PC)

Tensão de saída	2-42V DC
Potência de	1W
Potência até	21W
Fator de potência do aparelho de serviço	0.95
Proteção térmica	110°C
Número de saídas secundárias	1

Variante	Art. n.º	EUR
<input type="radio"/> Branco	1007226	30,00

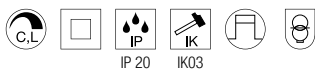
**DRIVER LED**  
20W | 350mA | regulável

IP 20 IK03

220-240V 0/~50/60Hz  
C: 11,6 cm L: 4,1 cm A: 2,5 cm  
Material: policarbonato (PC)

Tensão de saída	28-50V DC
Potência de	9.8W
Potência até	17.5W
Fator de potência do aparelho de serviço	0.95
Proteção térmica	110°C
Número de saídas secundárias	1

Variante	Art. n.º	EUR
<input type="radio"/> Branco	1007228	40,00

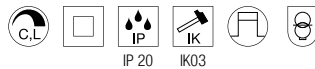
**DRIVER LED**  
20W | 350mA/500mA | PHASE

IP 20 IK03

220-240V 0/~50/60Hz  
C: 11,6 cm L: 4,1 cm A: 2,5 cm  
Material: policarbonato (PC)

- Ajustável através de DIP:  
350 mA (10,5 W) | 500 mA (15 W)

Tensão de saída	10-30V DC
Potência de	3.5W
Potência até	15W
Fator de potência do aparelho de serviço	0.95
Proteção térmica	110°C
Número de saídas secundárias	1

Variante	Art. n.º	EUR
<input type="radio"/> Branco	1007227	40,00

**DRIVER LED**  
10W | 180-270mA PHASE

NEW

220-240V ~50/60Hz  
C: 12,2 cm B: 4,1 cm A: 2,3 cm  
Material: plástico PC

Tensão de saída	26V-38V
Potência de	4,68W
Potência até	10W
Número de saídas secundárias	1

Variante	Art. n.º	EUR
<input type="radio"/> Branco	1008660	32,00

1007375 115

DRIVER LED  
10W | 500-700mA PHASE



NEW



220-240V ~50/60Hz  
C: 12,2 cm L: 4,1 cm A: 2,3 cm  
Material: plástico PC

Tensão de saída	8V-14V
Potência de	4W
Potência até	9,8W
Número de saídas secundárias	1

Variante	Art. n.º	EUR
<input type="radio"/> Branco	1008661	36,00





### DRIVER LED 15W | 200-350mA PHASE



NEW



220-240V ~50/60Hz  
C: 12,2 cm L: 4,1 cm A: 2,3 cm  
Material: plástico PC

Tensão de saída	26V-42V
Potência de	5,2W
Potência até	14,7W
Número de saídas secundárias	1

Variante	Art. n.º	EUR
<input type="radio"/> Branco	1008662	41,00

### DRIVER LED 20W | 350-500mA PHASE



NEW



220-240V ~50/60Hz  
C: 13,76 cm L: 4,4 cm A: 3 cm  
Material: plástico PC

Tensão de saída	26V-28V
Potência de	9,1W
Potência até	19W
Número de saídas secundárias	1

Variante	Art. n.º	EUR
<input type="radio"/> Branco	1008663	47,00

### DRIVER LED 30W | 500-700mA PHASE



NEW



220-240V ~50/60Hz  
C: 13,76 cm L: 4,4 cm A: 3 cm  
Material: plástico PC

Tensão de saída	26V-42V
Potência de	13W
Potência até	29,4W
Número de saídas secundárias	1

Variante	Art. n.º	EUR
<input type="radio"/> Branco	1008664	53,00

### DRIVER LED 40W | 700-1050mA PHASE



NEW



220-240V ~50/60Hz  
C: 17,23 cm L: 4,4 cm A: 3 cm

Tensão de saída	27V-38V
Potência de	26,6W
Potência até	39,9W
Número de saídas secundárias	1

Variante	Art. n.º	EUR
<input type="radio"/> Branco	1008665	57,00

### DRIVER LED 25W | 150-700mA | DALI regulável

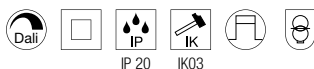

220-240V 0/~50/60Hz  
C: 11,9 cm L: 5,2 cm A: 2,25 cm  
Material: policarbonato (PC)

Tensão de saída	2-50V DC
Potência de	0,3W
Potência até	25W
Fator de potência do aparelho de serviço	0,95
Proteção térmica	110°C
Número de saídas secundárias	1

Variante	Art. n.º	EUR
<input type="radio"/> Branco	1007229	70,00

### DRIVER LED 15W | 100-700mA DALI



NEW



220-240V ~50/60Hz  
L: 10,34 cm A: 3 cm P: 2,1 cm  
Material: plástico PC

Tensão de saída	2.5V-46V
Potência de	0,25W
Potência até	15W
Proteção térmica	110°C
Número de saídas secundárias	1

Variante	Art. n.º	EUR
<input type="radio"/> Branco	1008666	71,00

### DRIVER LED 3W | 100-700mA DALI



NEW



220-240V ~50/60Hz  
L: 10,34 cm A: 3 cm P: 2,1 cm  
Material: plástico PC

Tensão de saída	2.5V-46V
Potência de	0,25W
Potência até	23,1W
Proteção térmica	110°C
Número de saídas secundárias	1

Variante	Art. n.º	EUR
<input type="radio"/> Branco	1008667	77,00

### DRIVER LED 36W | 100-900mA DALI



NEW



220-240V ~50/60Hz  
L: 12,8 cm A: 3 cm P: 2,1 cm  
Material: plástico PC

Tensão de saída	2.5V-50V
Potência de	0,37W
Potência até	36W
Número de saídas secundárias	1

Variante	Art. n.º	EUR
<input type="radio"/> Branco	1008668	83,00

### DRIVER LED 53W | 650-1400mA DALI



NEW



Material: plástico PC

Tensão de saída	1.62V-44V
Potência de	1,62W
Potência até	53,2W
Número de saídas secundárias	1

Variante	Art. n.º	EUR
<input type="radio"/> Branco	1008669	92,00

### ACESSÓRIO PARA DRIVERS Padrão



NEW

C: 3,4 cm L: 3 cm A: 2,1 cm  
Material: plástico PC

- Para drivers reguláveis DALI: 1008666, 1008667, 1008668

Variante	Art. n.º	EUR
<input type="radio"/> Branco	1008672	0,85

### ACESSÓRIO PARA DRIVERS Padrão



NEW



Material: plástico PC

- Para drivers DALI reguláveis: 1008669

Variante	Art. n.º	EUR
<input type="radio"/> Branco	1008674	0,85

### ACESSÓRIO PARA DRIVERS Por cabo



NEW



C: 9,8 cm L: 5,8 cm A: 2,3 cm  
Material: plástico PC

- Para drivers reguláveis DALI: 1008666, 1008667, 1008668

Variante	Art. n.º	EUR
<input type="radio"/> Branco	1008673	2,30



### DRIVER LED

10,7W | 200mA | DALI regulável



220-240V ~50/60Hz  
C: 14,18 cm L: 4,38 cm A: 3 cm  
Material: policarbonato (PC)

Tensão de saída	10-40V DC
Potência de	1,5W
Potência até	10,7W
Fator de potência do aparelho de serviço	0,9
Proteção térmica	110°C
Número de saídas secundárias	1

Variante	Art. n.º	EUR
<input type="radio"/> Branco	1006456	85,00

### DRIVER LED

12W | 250mA DALI regulável com interface RF



220-240V ~50/60Hz  
C: 14,18 cm L: 4,38 cm A: 3 cm  
Material: policarbonato (PC)

Tensão de saída	10-40V DC
Potência de	1,5W
Potência até	12W
Fator de potência do aparelho de serviço	0,9
Proteção térmica	110°C
Número de saídas secundárias	1

Variante	Art. n.º	EUR
<input type="radio"/> Branco	1006194	85,00

### DRIVER LED

40W | 500mA DALI regulável com interface RF

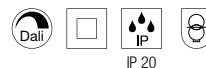

220-240V ~50/60Hz  
C: 12,3 cm L: 7,9 cm A: 3 cm  
Material: policarbonato (PC)

Tensão de saída	10-42V DC
Potência de	5W
Potência até	42W
Fator de potência do aparelho de serviço	0,95
Proteção térmica	110°C
Número de saídas secundárias	1

Variante	Art. n.º	EUR
<input type="radio"/> Branco	1006195	100,00

### DRIVER LED

40W | 700mA DALI regulável com interface RF

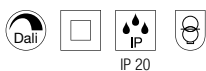

220-240V ~50/60Hz  
C: 12,3 cm L: 7,9 cm A: 3 cm  
Material: policarbonato (PC)

Tensão de saída	10-42V DC
Potência de	5W
Potência até	42W
Fator de potência do aparelho de serviço	0,95
Proteção térmica	110°C
Número de saídas secundárias	1

Variante	Art. n.º	EUR
<input type="radio"/> Branco	1006196	100,00

### DRIVER LED

40W | 1050mA DALI regulável com interface RF

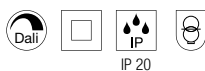

220-240V ~50/60Hz  
C: 12,3 cm L: 7,9 cm A: 3 cm  
Material: policarbonato (PC)

Tensão de saída	10-40V DC
Potência de	5W
Potência até	42W
Fator de potência do aparelho de serviço	0,95
Proteção térmica	110°C
Número de saídas secundárias	1

Variante	Art. n.º	EUR
<input type="radio"/> Branco	1006197	100,00

### DRIVER LED DALI

40W | 1050mA DALI CCT tunable

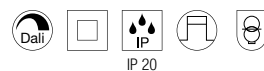

220-240V ~50/60Hz  
C: 12,3 cm L: 7,9 cm A: 3 cm  
Material: policarbonato (PC)

Tensão de saída	10-40V DC
Potência de	5W
Potência até	42W
Fator de potência do aparelho de serviço	0,9
Proteção térmica	110°C
Número de saídas secundárias	7

Variante	Art. n.º	EUR
<input type="radio"/> Branco	1006198	155,00

## MÓDULO ZIGBEE PARA DRIVER DALI, 1 CANAL



3,3 V  
C: 4,3 cm L: 3,1 cm A: 1,2 cm  
Material: policarbonato (PC)

Tensão nominal 3,3V

Variante	Art. n.º	EUR
<input type="radio"/> Branco	1006199	38,00

## MÓDULO CASAMBI PARA DRIVER DALI



3,3 V  
C: 4,3 cm L: 3,1 cm A: 1,2 cm  
Material: policarbonato (PC)

Tensão nominal 3,3V

Variante	Art. n.º	EUR
<input type="radio"/> Branco	1006454	129,00

## MÓDULO ZIGBEE PARA DRIVER DALI, 2 CANAIS



3,3 V  
C: 4,3 cm L: 3,1 cm A: 1,2 cm  
Material: policarbonato (PC)

Tensão nominal 3,3V

Variante	Art. n.º	EUR
<input type="radio"/> Branco	1006455	38,00

## DRIVER DT8 COM FUNÇÃO PUSH-DIM

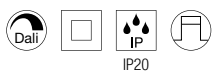

12-36V DC  
C: 17 cm L: 5,34 cm A: 2,8 cm  
Material: policarbonato (PC)

Tensão de saída	12-36VDC
Potência de	60W
Potência até	180W
Número de saídas secundárias	5

Variante	Art. n.º	EUR
<input type="radio"/> Branco	1007997	120,00

## TELECOMANDO SMART Zigbee, CCT/RGBW



Funcionamento a bateria  
C: 14 cm L: 4,4 cm A: 1,7 cm  
Material: policarbonato (PC)

Variante	Art. n.º	EUR
<input type="radio"/> Branco	1007827	79,00

## KIT DE EMERGÊNCIA DALI 2

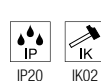

Material: policarbonato (PC)

para utilização com e sem linha de controlo DALI para consulta remota do estado

Dados no modo de iluminação de emergência:  
6-54V  
383-42@3,2 V

Potência de luz:  
2,3 W

Variante	Art. n.º	EUR
<input type="radio"/> Branco	1007892	129,00





## GANCHO PARA TETO



IP 20

C: 4,6 cm Ø: 1,8 cm  
Material: alumínio

Variante	Art. n.º	EUR
● Preto	132670	19,20
○ Branco	132671	19,20

## BRAÇADEIRA DE CABOS



IP 20

C: 3,1 cm Ø: 1,4 cm  
Material: alumínio

Variante	Art. n.º	EUR
● Preto	132680	12,50
○ Branco	132681	12,50

## GLENOS®



IP 20

220-240V ~50/60Hz  
C: 8,5 cm L: 8,5 cm A: 2,7 cm  
Material: alumínio

Tensão nominal	220-240V ~50/60Hz
Carga de corrente máx.	8.5A

Variante	Art. n.º	EUR
● Preto	210060	32,00
○ Branco	210061	32,00
● Cinzento	210064	32,00

CABO TÊXTIL  
10m

IP 20

C: 1000 cm  
Ø: 0,6 cm  
Material: cloreto de polivinilo (PVC)/têxtil

Tensão máx.	300V ACV
-------------	----------

Variante	Art. n.º	EUR
● Preto	961270	62,00

GU10 LED  
CONNECTION BOX  
com casquilho, máx. 10 W

IP 20

220-240V ~50/60Hz  
C: 3,8 cm L: 3,1 cm A: 1,7 cm  
Material: plástico

Tensão nominal	220-240V ~50/60Hz
----------------	----------------------

Variante	Art. n.º	EUR
● Preto	1007283	6,00

GU10 CONNECTION BOX  
com casquilho, universal

IP 20

C: 2,8 cm L: 2,8 cm A: 3,7 cm  
Material: cerâmico/plástico

Variante	Art. n.º	EUR
● Branco/Preto	1000909	7,75

**CABO**  
3 pinos, 3 x 0,75 mm<sup>2</sup>, 10 m



C: 1000 cm

Tensão máx. 300V

Variante	Art. n.º	EUR
	961250	27,25

**CASQUILHO GU10**



IP 20

230V ~50Hz  
A: 1,6 cm Ø: 2,8 cm  
Material: cerâmica

Tensão nominal 230V ~50Hz

Variante	Art. n.º	EUR
○ Branco	955135	2,05

**IIGADOR ESTANQUE**  
IP68, 3 polos



IP 68

230V ~50Hz  
C: 11,5 cm Ø: 2,7 cm  
Material: poliamida (PA)

Tensão nominal 230V ~50Hz  
Tensão máx. 450V  
Carga de corrente máx. 17.5A

Variante	Art. n.º	EUR
● Preto	228730	18,00

**CONNECTION BOX T**  
IP68, 3 polos



IP 68

230V ~50Hz  
C: 11 cm L: 6,4 cm A: 3 cm  
Material: poliamida (PA)

Tensão nominal 230V ~50Hz  
Tensão máx. 500V  
Carga de corrente máx. 17.5A

Variante	Art. n.º	EUR
● Preto	228726	33,00

**IIGADOR ESTANQUE**  
IP68, 5 polos



IP 68

230V ~50Hz  
C: 13 cm Ø: 3,2 cm  
Material: poliamida (PA)

Tensão nominal 230V ~50Hz  
Tensão máx. 450V  
Carga de corrente máx. 32A

Variante	Art. n.º	EUR
● Preto	228725	19,90

**CONNECTION BOX Y**  
5 Polos, DALI



IP 68

450 V  
C: 18 cm L: 6,3 cm A: 3,3 cm  
Material: poliamida 66 (PA 66)

Tensão nominal 450V  
Carga de corrente máx. 16A

Variante	Art. n.º	EUR
● Preto	1006453	35,00



1000666 774

Nota: encontra o n.º de artigo de 7 dígitos a partir da página 1063

<b>111000</b>		132021	457	143060	555
111262	156	132024	457	143061	555
111292	157	132600	226, 227, 279, 281	143062	555
111382	131	132601	226, 227, 279, 281	143070	555
		132605	226, 227, 279, 281	143071	555
<b>112000</b>		132610	299, 309	143072	555
112221	145	132611	299, 309	143080	555
112222	145	132660	300	143081	555
112225	145	132661	300	143082	555
112242	152	132662	300	143090	555
112682	145	132670	299, 1057	143091	555
112692	145	132671	299, 1057	143092	555
112720	156	132680	299, 1057	143100	555
112721	156	132681	299, 1057	143101	555
112780	156, 157	132690	299	143102	555
112781	156, 157	132691	299	143110	555
112910	138	132835	772	143111	555
112911	138			143112	555
		<b>133000</b>		143120	226, 227, 279, 281
<b>113000</b>		133444	311	143121	226, 227, 279, 281
113140	137			143124	226, 227, 279, 281
113141	137	<b>135000</b>		143130	555
113150	137	135250	242, 243, 244, 245	143131	555
113151	137	135251	191, 242, 243, 244, 245	143132	555
113160	138	135254	250, 251, 352, 353	143151	555
113161	138			143152	555
113170	139	<b>138000</b>		143160	555
113171	139	138981	543, 1046	143161	555
113262	156	138982	543, 1046	143162	555
113292	157	138991	543, 1046	143169	555
113540	131	138992	543, 1046	143170	554, 557
113541	131			143171	554, 557
113550	131	<b>139000</b>		143172	554, 557
113830	131	139004	540	143190	591
113840	131	139006	541	143191	591
113841	131	139024	540	143221	557
113930	181	139026	541	143230	557
113931	181	139030	540	143231	557
113940	181	139031	540	143241	557
113941	181	139040	540	143251	557
113970	130	139041	540	143261	557
113971	130	139050	541	143271	557
113976	130	139051	541	143281	557
		139060	541	143350	599
<b>114000</b>		139061	541	143351	599
114420	163	139070	544	143390	591
114421	163	139071	544	143391	591
114426	163	139072	544	143392	591
114430	163	139080	544	143430	597
114431	163	139081	544	143431	597
114436	163	139082	544	143432	597
114440	164	139090	545	143440	597
114441	164	139091	545	143441	597
114450	165	139092	545	143442	597
114451	165	139100	547	143450	593
		139101	547	143451	593
<b>115000</b>		139102	547	143454	593
115510	66	139120	549	143540	581
115511	66	139121	549	143541	581
115520	66	139122	549	143544	581
115521	66	139130	547	143580	589
115530	66	139131	547	143581	589
115531	66	139132	547	143594	592
115540	67			143731	581
115541	67	<b>143000</b>		143811	598
115550	67	143010	553	143941	594
115551	67	143011	553	143951	594
		143012	553	143960	595
<b>117000</b>		143020	553	143961	595
117100	205	143021	553		
117101	205	143022	553	<b>144000</b>	
117110	205	143030	555	144200	593
117111	205	143031	555	144201	593
117311	148	143032	555	144204	593
117321	202	143040	555		
117331	148	143041	555	<b>145000</b>	
117351	202	143042	555	145100	613
		143050	555	145102	613
<b>132000</b>		143051	555	145200	613
132020	457	143052	555	145202	613

145300	613	148060	390	152640	665
145302	613	148070	151	152641	665
145510	615	148071	151	152960	665
145514	615	148091	389	152961	665
145520	615	148540	416		
145524	615			<b>153000</b>	
145530	615	<b>149000</b>		153420	659
145534	615	149452	409	153421	659
145551	617	149762	359	153560	661
145560	615	149772	359	153561	661
145564	615			153564	661
145580	615	<b>151000</b>		153850	659
145584	615	151271	396	153851	659
145590	615	151275	396		
145594	615	151282	365	<b>155000</b>	
145600	615	151320	392	155156	213
145604	615	151321	392	155236	469
145630	615	151410	397	155373	209
145634	615	151411	397	155490	497
145640	615	151450	397	155540	495
145644	615	151451	397	155550	206
145660	615	151511	203	155551	206
145664	615	151531	203, 456	155582	207, 301, 497
145670	615	151591	402	155583	207, 301, 497
145674	615	151710	398	155592	207, 301, 497
145680	615	151711	398	155780	495
145684	615	151740	398	155790	495
145690	615	151741	398		
145694	615	151781	360	<b>156000</b>	
145700	615	151786	360	156050	208
145710	615	151791	360	156051	208
145714	615	151796	360	156100	207, 301
145720	615	151800	407	156111	207, 301, 497
145724	615	151801	407	156113	207, 301, 497
145730	615	151803	407	156122	207, 301, 497
145734	615	151810	197		
145830	615	151811	197	<b>158000</b>	
145834	615	151830	455	158400	305
145990	226, 227, 279, 281	151831	455	158410	307
145994	226, 227, 279, 281	151840	197, 407, 455		
		151850	309	<b>161000</b>	
<b>146000</b>		151851	309	161271	149
146010	499	151853	309	161291	149
146332	417	151950	160	161461	212
146682	415	151952	160		
146692	415	151960	160	<b>165000</b>	
		151962	160	165359	321
				165390	319
<b>147000</b>		<b>152000</b>		165400	319
147301	453	152010	455	165410	319
147306	453	152011	455		
147311	453	152020	455	<b>175000</b>	
147316	453	152021	455	175060	607
147321	453	152101	197	175080	607
147326	453	152230	663	175160	607
147360	431	152231	663	175180	607
147361	431	152232	663	175190	607
147370	431	152240	663	175210	607
147371	431	152241	663		
147380	431	152242	663	<b>181000</b>	
147381	431	152320	658	181530	543
147441	435	152321	658	181531	543
147442	435	152330	445	181532	543
147443	435	152331	445		
147444	435	152340	411	<b>186000</b>	
147529	402	152341	411	186300	543
147550	457	152360	305	186301	543
147551	457	152370	307	186302	543
147559	457	152380	150	186310	543
		152381	150	186311	543
<b>148000</b>		152430	665	186312	543
148001	211	152431	665	186330	543
148002	211	152600	662	186331	543
148004	210	152601	662	186332	543
148005	211	152610	662	186340	543
148010	387	152611	662	186341	543
148012	391	152750	658	186342	543
148013	391	152751	658	186350	543
148016	391	152780	658	186351	543
148018	386	152781	658	186352	543
148019	389				

186360	543	229422	752, 753, 754, 755, 759, 774	231525	821
186361	543	229423	757	231535	821
186362	543	229430	757	231541	835
186640	543	229431	757	231545	835
186641	543	229432	757	231585	924
186642	543	229524	862	231595	784
		229525	862	231815	787
<b>210000</b>		229531	861	231817	787
210060	320, 1057	229532	861	231960	808
210061	1057	229535	861	231961	808
210064	1057	229551	833		
		229554	833	<b>232000</b>	
<b>227000</b>		229555	833	232045	923
227176	925	229564	863	232075	771
227195	910	229565	863	232085	771
227219	769	229574	861	232101	921
227220	769	229575	861	232105	921
227221	769	229664	921	232115	743
227410	810	229665	921	232119	743
227418	810	229702	955	232125	743
227462	978	229740	811	232135	791
227505	807	229741	813	232145	791
227600	984	229931	944	232155	788
227604	984	229935	944	232165	788
227680	987	229961	942	232185	789
227684	987	229965	942	232195	788, 789
227922	779, 780	229971	943	232285	927
		229975	943	232294	799
				232295	799
<b>228000</b>		<b>230000</b>		232431	890
228100	779	230030	897	232435	890
228130	779	230034	897	232441	893
228332	979	230044	884	232445	893
228342	979	230045	884	232461	892
228412	969	230060	739, 773, 783, 801	232465	892
228430	975	230061	783	232485	919
228434	975	230063	783	232491	919
228555	817	230066	783	232495	919
228560	817	230069	783	232497	919
228712	765, 765, 777, 801	230084	885	232531	879
228722	765, 777	230085	885	232535	879
228725	1058	230090	752	232537	879
228726	1058	230355	925	232905	917
228730	1058	230365	905	232915	917
228752	801	230435	772		
228753	718, 771, 787	230444	884	<b>233000</b>	
228754	743, 747	230445	884	233094	941
228771	899	230465	771	233095	941
228775	899	230655	885	233104	931
228776	899	230657	885	233105	931
228925	777			233114	904
228935	777	<b>231000</b>		233115	904
228945	777	231010	896	233134	929
228960	775	231012	896	233135	929
228965	775	231015	896	233145	801
		231035	812	233165	801
<b>229000</b>		231072	809	233185	801
229020	758	231205	881	233214	931
229021	758	231215	747	233215	904, 929
229022	758	231225	747	233245	939
229062	955	231230	743, 747, 750, 751	233255	939
229071	945	231231	798	233302	899
229072	945	231233	760	233427	754
229075	945	231234	767, 781, 785	233437	755
229081	945	231235	761	233447	750
229085	945	231305	798	233457	750
229090	813	231315	926	233500	970
229162	780	231351	902	233520	970
229172	780	231355	902	233540	977
229200	977	231370	761	233570	815
229230	976	231371	761	233571	815
229234	977	231410	759	233580	815
229320	973	231411	759	233582	815
229324	973	231420	760	233601	951
229374	973	231440	761	233605	951
229381	969	231455	787	233615	951
229383	969	231457	787	233621	951
229410	751	231475	784	233625	951
229411	751	231505	801	233635	950
229420	755	231515	938	233639	950
229421	755				

233650	953	1000561	678	1000892	433
233660	953	1000566	678	1000893	433
<b>234000</b>		1000567	678	1000895	433
234505	862	1000571	678	1000896	433
234515	861	1000574	157	<b>1000900</b>	
234525	863	1000575	157	1000909	1057
234535	833	1000576	156	1000910	405
<b>900000</b>		1000577	156	1000911	405
900011	813, 815	1000579	207, 301, 497	1000914	136
<b>955000</b>		1000580	207, 301, 497	1000915	136
955135	1058	<b>1000600</b>		1000917	136
<b>961000</b>		1000613	381	1000926	295
961250	1058	1000614	383	1000927	295
961270	1057	1000616	381	1000929	295
<b>1000100</b>		1000618	381	1000930	295
1000127	451	1000621	383	1000932	295
1000128	451	1000623	383	1000933	295
1000129	451	1000634	397	1000935	295
1000130	451	1000638	392	1000936	295
1000131	451	1000639	392	1000957	207, 301
1000132	451	1000640	392	<b>1001000</b>	
1000135	451	1000665	774	1001015	155
1000136	451	1000666	774	1001016	155
<b>1000300</b>		1000668	368	1001019	473
1000327	405	1000669	368	1001020	473
1000329	405	1000670	368	<b>1001100</b>	
1000330	405	1000682	778	1001165	153
1000332	837	1000683	778	1001166	153
1000334	907	1000685	215	1001167	153
1000335	927	1000686	215	1001168	153
1000336	925	1000688	215	1001169	153
1000339	837	1000689	215	1001171	153
1000340	907	1000691	215	1001172	153
1000342	907	1000692	215	<b>1001200</b>	
1000343	785	1000694	215	1001254	983
1000344	785	1000695	215	1001255	983
1000345	785	<b>1000700</b>		1001262	983
1000346	785	1000702	453	1001263	983
1000398	773	1000703	453	1001264	155
<b>1000400</b>		1000704	453	1001272	408
1000458	671	1000711	594	1001273	408
1000459	671	1000712	594	1001274	408
1000461	671	1000714	146	1001275	408
1000462	671	1000715	146	1001276	408
1000464	671	1000716	146	1001283	369, 475
1000465	671	1000717	146	1001284	369, 475
1000466	673, 675	1000718	146	1001286	369, 475
1000468	673, 675	1000719	146	1001287	369, 475
1000469	673, 675	1000720	146	1001289	369
1000473	673	1000721	146	<b>1001300</b>	
1000474	673	1000726	191, 253	1001300	369
1000476	673	1000729	407	1001303	369
1000477	673	1000730	407	1001304	369
1000479	673	1000735	817	1001309	295
1000480	673	1000736	801, 817	1001310	295
1000487	673	1000773	300	1001380	607
1000489	673	1000777	367	1001382	607
1000497	677	1000780	367	1001390	607
1000498	677	1000783	217	1001392	607
<b>1000500</b>		1000784	217	1001393	607
1000524	677	1000785	217	1001395	607
1000525	677	1000786	217	<b>1001400</b>	
1000533	677	<b>1000800</b>		1001400	293
1000534	677	1000807	199	1001403	293
1000535	679	1000809	199, 310	1001406	293
1000536	679	1000813	310	1001409	293
1000540	678	1000820	923	1001460	498
1000546	678	1000821	773	1001461	498
1000549	678	1000822	773	1001462	498
1000557	679	1000823	834	1001463	498
1000558	679	1000833	155	1001468	416
1000560	678	1000880	929	1001472	416
		1000881	929	1001488	781
		1000886	433	1001489	781
		1000887	433		
		1000889	433		
		1000890	433		

1001490	781	1002029	431	1002645	607
1001494	781	1002030	431	1002646	607
<b>1001500</b>		1002032	877	1002655	607
1001510	613	1002033	877	1002656	607
1001511	613	1002034	877	1002657	607
1001512	613	1002035	919	1002658	607
1001513	615	1002069	897	1002659	607, 611
1001514	615	1002070	897	1002660	607, 611
1001515	615	1002075	467	1002690	549
1001516	615	1002076	467	1002691	543, 1046
1001517	615	1002077	467	1002692	543, 1046
1001518	615	1002098	162	1002693	543, 1046
1001519	615	1002099	162	1002694	549
1001520	615	<b>1002100</b>		1002695	549
1001521	615	1002100	162	1002696	549
1001522	615	1002101	162	1002697	543
1001523	615	1002102	162	1002698	543
1001524	615	1002110	595	1002699	543
1001525	615	1002111	595	<b>1002700</b>	
1001526	615	1002113	595	1002700	543
1001527	615	1002117	415	1002701	543
1001528	615	1002118	415	1002702	543
1001529	615	1002140	411	1002703	543
1001530	615	1002151	553	1002704	543
1001531	617	1002152	553	1002705	543
1001532	617	1002153	553		
1001533	617	1002163	226, 227, 279, 281	<b>1002800</b>	
1001534	617	1002190	363	1002842	393
1001536	617	1002191	363	1002843	393
1001537	617	1002192	363	1002844	393
1001538	617	<b>1002200</b>		1002845	555, 607, 615, 865
1001539	617	1002201	819	1002854	581
1001542	226, 227, 279, 281	1002203	819	1002855	409
1001574	1035	1002215	203, 456	1002860	417
1001575	1035	1002216	203	1002861	547
<b>1001800</b>		1002218	1046	1002862	547
1001861	598	1002221	1047	1002863	547
1001868	591	1002228	364	1002864	548
1001869	591	1002229	364	1002865	548
1001871	661	1002238	387	1002866	548
1001872	661	1002239	361	1002867	931
		1002240	361	1002868	911
<b>1001900</b>		<b>1002400</b>		1002869	911
1001930	152	1002402	883	1002871	764
1001931	152	1002403	883	1002882	191, 253
1001939	212	1002430	415	1002884	931
1001950	191, 242, 243, 244	1002431	415	1002893	971
1001951	250, 251, 352, 353	<b>1002500</b>		1002897	971
1001952	242, 243, 244, 245	1002503	903	1002899	971
1001962	813	1002504	903	<b>1002900</b>	
1001963	813	1002505	903	1002900	859
1001964	810	1002591	139	1002903	937
1001965	810	1002592	139	1002904	937
1001969	902	1002594	139	1002905	929
1001970	902	1002596	139	1002906	739
1001999	767	<b>1002600</b>		1002907	739
<b>1002000</b>		1002602	540	1002909	271
1002000	767	1002603	540	1002910	271
1002001	767	1002604	540	1002911	273
1002002	923	1002607	415	1002912	273
1002003	181	1002608	415	1002913	275
1002004	193	1002631	605	1002914	275
1002005	193	1002632	605	1002915	357
1002006	193	1002633	605	1002917	357
1002008	181	1002634	605	1002918	357
1002010	193	1002635	605	1002919	357
1002011	193	1002636	605	1002922	161
1002012	193	1002637	607	1002928	393
1002013	193	1002638	607	1002929	393
1002015	193	1002639	607	1002931	407
1002018	905	1002640	607	1002933	407
1002020	465	1002641	607, 611	1002934	198
1002021	465	1002642	607, 611	1002936	198
1002022	465	1002643	607	1002937	309
1002023	453	1002644	607	1002937	309
1002024	453			1002939	309
1002025	453			1002940	468
				1002941	468
				1002949	315



1002950	315	1003439	831	<b>1004400</b>	
1002951	315	1003440	867	1004410	182
1002952	898	1003441	869	1004434	232
1002953	898	1003442	829	1004482	338
1002954	898	1003443	283		
1002955	898	1003444	283	<b>1004500</b>	
1002956	793	1003447	808	1004506	184
1002957	793	1003448	808	1004530	234
1002958	793	1003449	943	1004578	340
1002959	793	1003450	943		
1002967	212	1003451	943	<b>1004600</b>	
1002968	212	1003452	943	1004602	186
1002979	159	1003453	897	1004626	236
1002980	159	1003454	897	1004649	931
1002981	159	1003455	412	1004650	894
1002982	161	1003456	413	1004651	894
1002983	161	1003457	412	1004652	819
1002984	161	1003458	413	1004653	938
1002989	915	1003459	413	1004660	378
1002990	915	1003460	413	1004661	378
1002991	797	1003467	395	1004662	378
1002992	797	1003468	395	1004663	378
		1003470	859	1004664	445
<b>1003000</b>		1003479	828, 829, 831	1004665	445
1003001	800			1004666	196
1003004	281	<b>1003500</b>		1004667	196
1003005	281	1003506	367	1004668	147
1003006	281	1003507	367	1004669	147
1003007	281	1003508	367	1004670	385
1003008	141	1003518	941	1004671	385
1003009	141	1003519	941	1004672	296
1003010	141	1003530	292	1004673	296
1003011	143	1003532	292	1004674	299, 320, 653
1003012	143	1003535	763	1004675	299, 653
1003013	143	1003536	762	1004677	833
1003014	461	1003537	763	1004678	895
1003015	461	1003538	763	1004679	895
1003016	461	1003539	921	1004680	765
1003017	459	1003553	82	1004681	765
1003018	459			1004682	404
1003019	459	<b>1003600</b>		1004684	607
1003040	217	1003625	84	1004685	607
1003041	217	1003697	86	1004686	649
1003042	217	1003769	70	1004687	649
1003043	217	1003841	72	1004688	649
1003044	291	1003913	74	1004689	649
1003045	291	1003985	76	1004690	649
1003046	291			1004691	649
1003047	291	<b>1004000</b>		1004692	649
		1004054	100	1004693	649
<b>1003100</b>		1004055	99	1004694	141
1003104	687, 689, 1049	1004058	99	1004695	141
1003105	688, 1049	1004059	102	1004696	141
1003106	692, 1047	1004062	101	1004697	143
		1004064	100	1004698	143
<b>1003300</b>		1004065	101	1004699	143
1003316	399	1004066	102		
		1004067	99	<b>1004700</b>	
<b>1003400</b>		1004069	100	1004700	461
1003416	871	1004070	101	1004701	461
1003417	871	1004071	102	1004702	461
1003418	872	1004074	628	1004705	459
1003419	872	1004098	336	1004706	410
1003420	831			1004720	690
1003421	831	<b>1004100</b>		1004721	690
1003422	867	1004122	182	1004722	691
1003423	867	1004146	232	1004723	691
1003424	869	1004170	630	1004725	692
1003425	869	1004194	338	1004726	695
1003426	829			1004727	693
1003427	829	<b>1004200</b>		1004730	358
1003428	403	1004218	184	1004731	358
1003429	403	1004242	234	1004732	389
1003430	403	1004266	632	1004733	386
1003431	403	1004290	340	1004734	694
1003432	311			1004735	694
1003435	304	<b>1004300</b>		1004736	694
1003436	304	1004314	186	1004737	695
1003437	871	1004338	236	1004738	404
1003438	872	1004386	336	1004739	404

1004740	401	1004935	589	1005294	1038
1004741	401	1004936	589	1005295	1038
1004742	401	1004937	605	1005296	1038
1004743	401	1004938	605	1005297	1037
1004744	226, 227, 279, 281	1004939	607	1005298	1037
1004745	226, 227, 279, 281	1004940	607	1005299	1037
1004747	887	1004957	931		
1004748	887	1004969	378	<b>1005300</b>	
1004749	737	1004971	365	1005302	1039
1004750	737			1005303	1039
1004751	737	<b>1005000</b>		1005305	1043
1004757	809	1005075	973, 975, 987, 1036	1005307	1042
1004759	271	1005076	1036	1005308	1042
1004760	271	1005077	1036	1005310	1043
1004761	271	1005078	1036	1005317	1038
1004762	271	1005079	1036	1005318	1039
1004763	273	1005080	1036	1005319	80
1004764	273	1005081	1036	1005390	493
1004765	274	1005082	1036	1005391	493
1004766	274	1005083	1036	1005392	493
1004767	274	1005085	462	1005394	493
1004768	274	1005086	462	1005395	290
1004771	643	1005087	463	1005396	290
1004772	643	1005088	463	1005397	648
1004773	300, 497	1005089	944	1005399	648
1004774	207, 301, 497	1005090	944		
1004775	207, 301, 497			<b>1005400</b>	
1004783	555	<b>1005100</b>		1005400	648
1004784	555	1005125	891	1005401	648
1004785	555	1005126	891	1005402	648
1004786	99	1005148	877	1005435	138
1004787	99	1005149	877	1005436	138
1004788	99	1005150	877	1005439	738
1004789	99	1005151	879	1005440	738
1004790	100	1005153	879	1005441	800
1004791	100	1005154	879	1005442	749
1004792	100	1005155	879	1005443	889
1004793	100	1005156	879	1005499	68
1004794	101	1005157	879		
1004795	101	1005177	271	<b>1005500</b>	
1004796	101	1005178	274	1005553	78
1004797	101				
1004798	102	<b>1005200</b>		<b>1005600</b>	
1004799	102	1005201	882	1005609	98
		1005202	941	1005610	98
<b>1004800</b>		1005205	829, 831, 867, 869, 871	1005611	98
1004800	102	1005206	829, 831, 867, 869, 871	1005612	98
1004801	102	1005207	829, 831, 867, 869, 871	1005613	98
1004889	674	1005214	320	1005614	98
1004890	674	1005215	320	1005615	98
1004893	675	1005216	320	1005687	188
1004894	675	1005217	320		
1004895	675	1005218	320	<b>1005700</b>	
1004896	681	1005262	829, 831, 867, 869, 871	1005705	238
1004897	681	1005263	829, 831, 867, 869, 871	1005723	634
1004898	681	1005265	1042	1005741	342
1004899	681	1005268	1042	1005759	188
		1005269	1035	1005777	238
		1005271	1035	1005813	88
<b>1004900</b>		1005272	1035	1005867	90
1004900	682	1005273	973, 975, 1036	1005921	92
1004901	682	1005274	1037	1005975	94
1004902	682	1005275	977, 1037		
1004903	683	1005276	1037	<b>1006000</b>	
1004904	683	1005277	1037	1006029	96
1004905	681	1005278	976, 1037	1006083	342
1004906	681	1005279	1037		
1004907	681	1005280	1037	<b>1006100</b>	
1004908	681	1005281	1037	1006104	985
1004909	682	1005282	1037	1006105	985
1004910	682	1005283	1037	1006106	969
1004911	683	1005284	1035	1006107	969
1004912	682	1005285	1035	1006108	636
1004913	682	1005286	1034	1006121	137
1004914	682	1005287	1034	1006122	137
1004915	682	1005288	1034	1006123	471
1004916	682	1005289	977, 1041	1006124	471
1004917	682	1005290	1041	1006125	471
1004932	679	1005291	1037	1006126	471
1004933	589	1005292	1037	1006127	471
1004934	589				

1006128	471	1006352	483	1006513	609
1006133	692, 695, 1050	1006353	483	1006514	609
1006134	695, 1050	1006354	483	1006515	609
1006136	103	1006355	483	1006516	609
1006138	103	1006377	226, 227, 279, 281	1006517	609
1006140	103	1006378	299	1006518	609
1006142	103	1006379	729	1006519	611
1006144	103	1006380	729	1006520	611
1006146	103	1006381	729	1006521	611
1006148	103	1006382	720, 721, 722, 723	1006522	611
1006150	103	1006383	722	1006523	611
1006152	103	1006384	725	1006524	611
1006154	103	1006385	724	1006525	611
1006155	587	1006386	727	1006526	611
1006156	587	1006387	723	1006527	611
1006157	653	1006388	726	1006528	611
1006158	653	1006389	723	1006529	611
1006159	653	1006390	725	1006530	611
1006160	653	1006391	724	1006531	611
1006161	410	1006392	727	1006532	611
1006162	410	1006393	723	1006533	611
1006167	182, 184, 232, 23	1006394	726	1006534	611
1006168	630	1006395	281	1006535	611
1006169	186, 236, 632	1006396	281	1006536	611
1006170	188, 238, 634	1006397	281	1006537	611
1006171	981	1006398	281	1006538	611
1006172	981	1006399	281	1006539	611
1006173	981			1006540	611
1006174	981	<b>1006400</b>		1006541	503
1006175	981	1006400	281	1006542	503
1006176	981	1006402	281	1006543	503
1006178	880	1006403	281	1006544	503
1006179	880	1006404	855	1006545	503
1006180	745	1006405	855	1006546	503
1006181	745	1006406	949	1006547	503
1006182	745	1006407	949	1006548	503
1006183	881	1006408	733	1006549	507
1006184	747	1006409	733	1006550	507
1006185	277	1006410	320	1006551	507
1006186	277	1006423	443	1006552	507
1006187	277	1006424	443	1006553	507
1006188	277	1006425	443	1006554	507
1006189	277	1006426	443	1006555	507
1006190	277	1006427	443	1006556	507
1006191	1029	1006428	443	1006557	511
1006192	1029	1006429	443	1006558	511
1006193	1029	1006430	443	1006559	511
1006194	1055	1006431	287	1006560	511
1006195	1055	1006432	287	1006561	511
1006196	1055	1006433	287	1006562	511
1006197	1055	1006434	287	1006563	511
1006198	1055	1006435	287	1006564	511
1006199	1056	1006436	287	1006565	504, 508, 512
		1006437	287	1006566	504, 508, 512
<b>1006200</b>		1006438	287	1006567	504, 508, 512
1006268	857	1006439	201	1006568	504, 508, 512
1006270	857	1006440	201	1006569	505, 509, 513
		1006441	375	1006570	505, 509, 513
<b>1006300</b>		1006442	375	1006571	505, 509, 513
1006307	385	1006443	375	1006572	505, 509, 513
1006308	385	1006444	375	1006573	505, 509, 513
1006314	887	1006445	585	1006574	505, 509, 513
1006316	827	1006446	585	1006575	505
1006317	377, 858	1006449	201, 287, 375, 443, 585	1006576	505
1006318	377, 858	1006450	201, 287, 375, 443, 585	1006577	505
1006319	377, 858	1006451	201, 287, 375, 443, 585	1006578	505
1006321	1036	1006452	1046	1006579	505
1006326	1029	1006453	1058	1006580	505
1006327	828	1006454	1056	1006581	509
1006328	865	1006455	1056	1006582	509
1006329	865	1006456	1055	1006583	509
1006336	686, 1049	1006457	98	1006584	509
1006343	493	1006458	99	1006585	509
1006344	493	1006459	100	1006586	509
1006345	290	1006460	101	1006587	513
1006346	753	1006461	102	1006588	513
1006347	753			1006589	513
1006348	692, 693, 695, 1047	<b>1006500</b>		1006590	513
1006350	483	1006511	609	1006591	513
1006351	483	1006512	609	1006592	513

1006593	505	1007145	853	1007309	245, 347
1006594	505	1007146	807	1007310	249, 351
1006595	509	1007147	807	1007311	249, 351
1006596	509	1007184	59, 1011	1007312	245, 347
1006597	513	1007185	59, 1011	1007313	245, 347
1006598	513	1007186	59	1007314	249, 351
1006599	505, 509, 513	1007188	509, 513	1007315	249, 351
		1007189	509, 513	1007316	250, 352
<b>1006600</b>		1007190	201, 287, 375, 443, 585	1007317	250, 352
1006600	505, 509, 513	1007191	59	1007318	250, 352
1006601	505, 509, 513	1007194	59	1007319	250, 352
1006602	505, 509, 513	1007195	959	1007320	250, 352
1006603	505, 509, 513	1007196	959	1007321	250, 352
1006604	505, 509, 513	1007197	959	1007322	251, 353
1006605	505, 509, 513	1007198	959	1007323	251, 353
1006606	505, 509, 513			1007324	251, 353
1006607	505, 509, 513	<b>1007200</b>		1007325	251, 353
1006608	505, 509, 513	1007200	359	1007326	251, 353
1006609	505, 509	1007201	358	1007327	251, 353
1006610	513	1007202	359	1007328	120
1006611	505	1007207	882	1007329	120
1006612	505	1007225	141, 143, 1051	1007330	120
1006613	505, 509, 513	1007226	1051	1007331	120
1006614	505, 509, 513	1007227	1051	1007332	120
1006615	523	1007228	1051	1007333	120
1006616	523	1007229	1053	1007334	120
1006617	523	1007230	1036	1007335	120
1006618	523	1007231	1036	1007336	121
1006619	523	1007232	720	1007337	121
1006620	523	1007233	720	1007338	121
1006621	525	1007234	721	1007339	121
1006622	525	1007235	721	1007340	122
1006623	525	1007236	852	1007341	122
1006624	525	1007237	718	1007342	122
1006625	525	1007238	965, 966, 967	1007343	122
1006626	525	1007239	965, 966, 967	1007344	122
1006627	523	1007240	965, 966, 967	1007345	121
1006628	523	1007241	966	1007346	121
1006629	523	1007242	967	1007347	121
1006630	523	1007243	965	1007348	121
1006631	523	1007244	965	1007349	122
1006632	523	1007245	965, 966, 967	1007350	122
1006633	525	1007250	1048	1007351	122
1006634	525	1007251	1048	1007352	583
1006635	525	1007252	1048	1007353	583
1006636	525	1007253	1048	1007354	583
1006637	525	1007254	1049	1007355	645
1006638	525	1007255	1049	1007356	645
1006639	527	1007256	1049	1007357	485, 703
1006640	527	1007257	1050	1007358	485, 703
1006641	527	1007281	847	1007359	485, 703
1006642	527	1007282	847	1007360	485, 703
1006643	527	1007283	1057	1007361	485, 703
1006644	527	1007284	242, 344	1007362	485, 703
1006645	527	1007285	242, 344	1007363	491
1006646	527	1007286	246, 348	1007364	491
1006647	527	1007287	246, 348	1007365	491
1006648	527	1007288	242, 344	1007366	491
1006649	527	1007289	242, 344	1007368	113
1006650	527	1007290	246, 348	1007369	113
1006651	514	1007291	246, 348	1007370	113
		1007292	243, 345	1007371	113
<b>1006700</b>		1007293	243, 345	1007372	113
1006705	516	1007294	247, 349	1007373	113
1006759	518	1007295	247, 349	1007374	115
1006813	520	1007296	243, 345	1007375	115
		1007297	243, 345	1007376	115
<b>1007000</b>		1007298	247, 349	1007377	115
1007083	505, 509, 513	1007299	247, 349	1007378	115
1007084	505, 509, 513			1007379	115
1007091	59, 1011	<b>1007300</b>		1007380	488, 707
1007092	59, 1011	1007300	244, 346	1007381	119
1007093	59	1007301	244, 346	1007382	119
		1007302	248, 350	1007383	119
<b>1007100</b>		1007303	248, 350	1007384	119
1007137	505, 509, 513	1007304	244, 346	1007385	105
1007138	505, 509, 513	1007305	244, 346	1007386	105
1007142	853	1007306	248, 350	1007387	105
1007143	853	1007307	248, 350	1007388	105
1007144	853	1007308	245, 347	1007389	105

1007390	105	1007478	1009	1007582	825
1007391	105	1007479	1009	1007583	713
1007392	105	1007480	1009	1007584	713
1007393	105	1007481	1009	1007585	845
1007394	105	1007482	1009	1007586	825
1007395	105	1007483	1009	1007587	713
1007396	105	1007484	1009	1007588	279
1007397	105	1007485	1009	1007589	279
1007398	105	1007486	1009	1007590	437
1007399	105	1007487	1009	1007591	437
		1007488	122	1007592	437
<b>1007400</b>		1007489	122	1007593	437
1007400	105	1007490	1014	1007594	373
1007401	107	1007491	1017	1007595	373
1007402	107	1007493	1015	1007596	279, 585
1007403	107	1007495	1017	1007597	279, 585
1007404	107	1007496	996	1007598	279
1007405	107	1007497	998	1007599	279
1007406	107	1007498	997		
1007407	107	1007499	999	<b>1007600</b>	
1007408	107			1007608	439
1007409	125	<b>1007500</b>		1007609	439
1007410	125	1007504	997	1007610	439
1007411	125	1007505	999	1007611	439
1007412	125	1007506	1018	1007612	331
1007421	119	1007507	1019	1007613	331
1007422	119	1007508	1008	1007614	331
1007423	109	1007509	1008	1007615	331
1007424	109	1007510	1008	1007616	331
1007425	109	1007511	843, 935	1007617	331
1007426	109	1007512	715	1007618	331
1007427	109	1007513	715	1007619	331
1007428	109	1007514	1027	1007624	115
1007429	109	1007515	1027	1007625	115
1007430	109	1007516	1001	1007626	115
1007431	119	1007517	1001	1007627	115
1007432	119	1007518	258	1007628	115
1007433	111	1007519	258	1007629	115
1007434	111	1007520	258	1007630	123
1007435	111	1007521	260, 534	1007631	123
1007436	111	1007522	260, 534	1007632	123
1007437	111	1007523	260, 534	1007633	123
1007438	111	1007524	260, 534	1007634	123
1007439	111	1007525	260, 534	1007635	123
1007440	111	1007526	260, 534	1007636	123
1007441	111	1007527	260	1007637	123
1007442	111	1007528	260	1007638	582
1007443	125	1007529	260	1007639	582
1007444	125	1007530	260, 535	1007640	582
1007445	125	1007531	260, 535	1007641	583
1007446	125	1007532	260, 535	1007642	583
1007447	125	1007533	261, 535	1007643	583
1007448	125	1007534	261, 535	1007644	644
1007449	122	1007535	261, 535	1007645	644
1007450	122	1007536	261, 535	1007646	644
1007451	121	1007537	261, 535	1007647	644
1007452	125	1007538	261, 535	1007648	645
1007453	121	1007539	261	1007649	645
1007454	125	1007540	261	1007651	709
1007455	1034	1007541	261	1007652	709
1007458	843, 935	1007542	260, 535	1007653	935
1007459	714	1007543	260, 535	1007654	1002
1007460	714	1007544	260, 535	1007655	1002
1007461	826	1007545	260, 535	1007656	1003
1007462	492	1007546	260, 535	1007657	1003
1007463	492	1007547	260, 535	1007658	257
1007464	492	1007548	259	1007659	257
1007465	492	1007549	259	1007660	257
1007466	492	1007550	259	1007661	269
1007467	492	1007551	65	1007662	269
1007468	289	1007552	65	1007663	269
1007469	289	1007559	65	1007664	269
1007470	289	1007560	65	1007665	269
1007471	289	1007567	65	1007666	269
1007472	289	1007568	65	1007667	846
1007473	289	1007575	997	1007668	846
1007474	997	1007576	999	1007669	719
1007475	999	1007577	996, 997, 998, 999	1007670	719
1007476	1009	1007580	713	1007671	269
1007477	1009	1007581	845	1007672	269

1007673	582
1007674	582
1007676	1025
1007677	1025
1007678	1025
1007679	1024
1007680	961
1007681	961
1007682	961
1007683	961, 962, 963
1007684	961, 962, 963
1007685	961, 962, 963
1007692	487, 705
1007693	487, 705
1007694	487, 705
1007695	487, 705
1007696	487, 705
1007697	487, 705
1007698	487, 705

**1007700**

1007701	265
1007702	265
1007703	265
1007710	170
1007711	170
1007712	170
1007714	170
1007715	170
1007716	441
1007717	441
1007718	441
1007720	441
1007721	441
1007722	171
1007723	171
1007724	171
1007726	171
1007727	171
1007728	171
1007729	171
1007730	171
1007732	171
1007733	171
1007734	171
1007735	171
1007736	171
1007738	171
1007739	171
1007740	57
1007741	57
1007742	57
1007744	57
1007745	57
1007746	269, 273
1007747	533
1007748	533
1007749	533

**1007800**

1007806	901
1007807	901
1007808	901
1007809	901
1007810	962
1007811	963
1007816	607
1007817	607
1007818	606
1007819	606
1007820	606
1007821	606
1007822	962, 963
1007827	1056
1007855	265
1007856	265
1007857	265
1007858	177, 225, 333, 479
1007859	177, 225, 333, 479
1007860	177, 225, 333, 479

1007868	816
1007869	816
1007870	505, 509, 513
1007871	505, 509, 513
1007872	505, 509, 513
1007873	505, 509, 513
1007876	283
1007877	283
1007878	283
1007879	283
1007880	283
1007881	283
1007892	1056

**1007900**

1007911	851
1007912	851
1007913	851
1007914	851
1007916	849
1007917	849
1007918	849
1007919	849
1007926	555
1007927	555
1007928	555
1007997	1056

**1008000**

1008000	983
1008001	983
1008002	267
1008003	267
1008004	267
1008005	127
1008006	127
1008007	127
1008008	127
1008009	127
1008010	908
1008011	908
1008012	909
1008013	909
1008014	740
1008015	740
1008016	741
1008017	741
1008023	177, 225, 333, 479
1008024	439
1008025	439
1008026	439
1008029	487, 487, 705
1008032	223
1008033	223
1008034	223
1008035	329
1008036	329
1008037	329
1008038	481
1008039	481
1008040	481
1008041	559
1008042	559
1008043	559
1008044	226
1008045	227
1008046	227
1008047	227
1008052	587
1008053	587
1008054	587
1008055	651
1008056	651
1008057	651
1008058	587
1008059	587
1008060	587
1008061	651
1008062	651
1008063	651

1008065	59
1008066	1011
1008067	59, 1011
1008068	59, 1011
1008069	59
1008070	59
1008071	399
1008081	355
1008082	355
1008083	355
1008084	354
1008085	354
1008086	354
1008087	1013
1008088	1013
1008095	59, 1011
1008096	59, 1011
1008097	59
1008098	59
1008099	177

**1008100**

1008100	177
1008101	177
1008102	177
1008103	177
1008104	333
1008105	333
1008106	333
1008107	333
1008108	333
1008109	478
1008110	478
1008111	478
1008112	478
1008113	478
1008114	225
1008115	225
1008116	225
1008117	225
1008118	225
1008119	177, 225, 333, 479
1008123	334
1008124	335
1008125	168
1008126	168
1008127	169
1008128	169
1008129	313
1008130	313
1008131	313
1008132	313
1008133	309
1008134	309
1008135	309
1008136	229
1008137	229
1008138	228
1008139	228
1008140	182, 232, 336, 338
1008141	184, 234, 630
1008142	186, 236, 632
1008143	188, 238, 634
1008144	182, 232, 336, 338
1008145	184, 234, 630
1008146	186, 236, 632
1008147	188, 238, 634
1008148	555
1008149	555
1008150	555
1008151	1040
1008152	1041
1008153	1039, 1041
1008154	1035
1008155	1040
1008156	1042
1008157	1043
1008158	1034
1008159	1040
1008160	1040

1008161	1040	1008241	427	1008319	424
1008162	1042	1008242	563	1008320	421
1008163	1040	1008243	563	1008321	421
1008164	1041	1008244	563	1008322	421
1008165	1041	1008245	563	1008323	421
1008168	579	1008246	563	1008324	423
1008169	579	1008247	563	1008325	423
1008170	656	1008248	563	1008326	423
1008171	656	1008249	563	1008327	423
1008172	285	1008250	563	1008328	425
1008173	285	1008251	563	1008329	425
1008174	579	1008252	563	1008330	425
1008175	579	1008253	563	1008331	425
1008176	657	1008254	565	1008332	421
1008177	657	1008255	565	1008333	421
1008178	285	1008256	565	1008334	421
1008179	285	1008257	565	1008335	421
1008180	576	1008258	565	1008336	423
1008181	576	1008259	565	1008337	423
1008182	577	1008260	565	1008338	423
1008183	577	1008261	565	1008339	423
1008184	657	1008262	565	1008340	425
1008185	657	1008263	565	1008341	425
1008186	285, 579, 657	1008264	565	1008342	425
1008187	285, 579, 657	1008265	565	1008343	425
1008188	285, 579, 657	1008266	619	1008344	421
1008189	285, 579, 657	1008267	619	1008345	421
1008190	285, 579, 657	1008268	619	1008346	421
1008191	285, 579, 657	1008269	619	1008347	421
1008192	285, 579, 657	1008270	619	1008348	423
1008193	711	1008271	619	1008349	423
1008194	711	1008272	619	1008350	423
1008195	711	1008273	619	1008351	423
1008196	711	1008274	619	1008352	425
1008197	844	1008275	621	1008353	425
1008198	844	1008276	621	1008354	425
1008199	825	1008277	621	1008355	425
		1008278	621	1008356	566
<b>1008200</b>		1008279	621	1008357	566
1008200	825	1008280	621	1008358	566
1008201	379	1008281	621	1008359	622
1008202	379	1008282	621	1008360	622
1008203	379	1008283	621	1008361	421
1008204	379	1008284	421	1008362	421
1008205	379	1008285	421	1008363	421
1008206	379	1008286	421	1008364	421
1008207	567	1008287	421	1008365	423
1008208	567	1008288	423	1008366	423
1008209	567	1008289	423	1008367	423
1008210	623	1008290	423	1008368	423
1008211	623	1008291	423	1008369	425
1008212	623	1008292	425	1008370	425
1008213	429, 567, 623	1008293	425	1008371	425
1008214	429, 567, 623	1008294	425	1008372	425
1008215	429, 567, 623	1008295	425	1008373	1041
1008216	429, 567, 623	1008296	421	1008375	1035
1008217	429, 567, 623	1008297	421	1008376	429, 567, 623
1008218	429, 567, 623	1008298	421	1008377	429, 567, 623
1008219	429, 567, 623	1008299	421	1008378	429, 567, 623
1008220	429, 567, 623			1008379	686
1008221	429, 567, 623	<b>1008300</b>		1008380	686
1008222	429, 567, 623	1008300	423	1008381	686
1008223	429, 567, 623	1008301	423	1008384	933
1008224	429, 567, 623	1008302	423	1008385	735
1008225	429, 567, 623	1008303	423	1008386	717
1008226	429, 567, 623	1008304	425	1008387	717
1008227	429, 567, 623	1008305	425	1008388	717
1008228	427	1008306	425	1008389	717
1008229	427	1008307	425	1008390	569
1008230	427	1008308	420	1008392	569
1008231	427	1008309	420	1008393	569
1008232	426	1008310	420	1008394	569
1008233	426	1008311	420	1008395	569
1008234	427	1008312	422	1008397	569
1008235	427	1008313	422	1008398	569
1008236	427	1008314	422	1008399	569
1008237	427	1008315	422		
1008238	427	1008316	424	<b>1008400</b>	
1008239	427	1008317	424	1008400	569
1008240	427	1008318	424	1008402	569

1008403	569	1008494	575, 627	1008584	419
1008404	569	1008495	575, 627	1008585	419
1008405	529	1008496	575, 627	1008586	419
1008407	529	1008497	575, 627	1008587	419
1008408	529	1008498	575, 627	1008588	419
1008409	529	1008499	575, 627	1008589	240
1008410	529			1008590	240
1008412	529	<b>1008500</b>		1008591	241
1008413	529	1008500	231	1008592	241
1008414	529	1008501	231	1008593	241
1008415	529	1008502	231	1008594	241
1008417	529	1008503	231	1008595	241
1008418	529	1008504	231	1008596	241
1008419	529	1008505	231	1008597	990
1008420	571	1008506	231	1008598	993
1008422	571	1008507	231		
1008423	571	1008508	231	<b>1008600</b>	
1008424	571	1008509	116	1008601	991
1008425	571	1008510	116	1008602	993
1008427	571	1008511	117	1008605	995
1008428	571	1008512	117	1008607	995
1008429	571	1008513	117	1008609	995
1008430	571	1008514	117	1008610	995
1008432	571	1008515	687	1008612	385
1008433	571	1008516	687	1008613	385
1008434	571	1008517	687	1008614	385
1008435	624	1008518	688	1008615	297
1008436	624	1008519	688	1008616	297
1008437	624	1008520	688	1008617	297
1008438	624	1008521	689	1008618	195
1008439	624	1008522	689	1008619	195
1008440	624	1008523	689	1008620	195
1008441	625	1008524	689	1008621	1005
1008442	625	1008525	1021	1008622	1005
1008443	625	1008526	1021	1008623	1005
1008444	625	1008527	1021	1008624	1005
1008445	625	1008528	1023	1008625	1006
1008446	625	1008529	1023	1008626	1006
1008447	573	1008530	1023	1008627	1007
1008449	573	1008531	1023	1008628	1007
1008450	573	1008532	1023	1008629	132
1008451	573	1008535	316	1008630	134
1008452	627	1008536	317	1008631	132
1008453	627	1008537	317	1008632	134
1008454	531	1008538	316	1008633	133
1008456	531	1008539	561	1008634	135
1008457	531	1008540	561	1008635	133
1008458	531	1008541	655	1008636	135
1008459	531	1008542	913	1008641	1039
1008461	531	1008543	796	1008642	1039
1008462	531	1008544	796	1008643	1039
1008463	531	1008545	173	1008644	1039
1008464	531	1008546	173	1008645	1042
1008466	531	1008547	173	1008646	1042
1008467	531	1008548	173	1008647	1034
1008468	531	1008549	173	1008648	1034
1008469	573	1008550	173	1008649	1034
1008471	573	1008551	175	1008650	1034
1008472	573	1008552	175	1008651	1048
1008473	573	1008553	175	1008652	1048
1008474	728	1008554	175	1008653	1047
1008475	728	1008555	175	1008654	1047
1008476	701	1008556	175	1008655	1047
1008477	701	1008567	62	1008656	1050
1008478	804	1008568	62	1008657	1050
1008479	804	1008569	62	1008658	1050
1008480	805	1008570	62	1008659	1051
1008481	953	1008571	63	1008660	132, 134, 1051
1008482	447, 449, 582, 583, 644, 645	1008572	63	1008661	1052
1008483	447, 449, 582, 583, 644, 645	1008573	63	1008662	1053
1008484	447, 449, 582, 583, 644, 645	1008574	63	1008663	132, 134, 1053
1008485	447, 449, 582, 583, 644, 645	1008575	1023	1008664	1053
1008486	447, 449, 582, 583, 644, 645	1008576	1022	1008665	133, 135, 1053
1008487	447, 449, 582, 583, 644, 645	1008577	418	1008666	132, 134, 1053
1008488	575	1008578	418	1008667	132, 134, 1054
1008489	575	1008579	418	1008668	1054
1008490	575	1008580	418	1008669	133, 135, 1054
1008491	575	1008581	419	1008672	132, 134, 1054
1008492	575, 627	1008582	419	1008673	132, 134, 1054
1008493	575, 627	1008583	419	1008674	133, 135, 1054



1008675	1046
1008676	647
1008677	647
1008678	647
1008679	647
1008680	1031
1008681	1031
1008682	1031
1008683	1031
1008684	1031
1008685	1031
1008686	1031
1008687	1031
1008688	1031
1008689	1031
1008690	1031
1008691	1031
1008692	1031
1008693	1031
1008694	1031
1008695	1031
1008696	1031
1008697	1031
1008698	152

**1008700**

1008703	447
1008704	447
1008705	447
1008706	447
1008707	447
1008708	447
1008709	449
1008710	449
1008711	449
1008712	449
1008713	449
1008714	449
1008715	449
1008716	449
1008717	449
1008718	449
1008719	449
1008720	449
1008721	916
1008722	916
1008723	916
1008724	916
1008725	795
1008726	795
1008727	795
1008728	647
1008729	647
1008730	647
1008731	647



VARYT  
1008111 + 1007858

**CALHA ELETRIFICADA MONOFÁSICA**

CALHA ELETRIFICADA SALIENTE	553
ACESSÓRIOS PARA CALHA SALIENTE	555
CALHA ELETRIFICADA PARA ENCASTRAR	557
ACESSÓRIOS PARA CALHA ENCASTRADA	557

**CALHA ELETRIFICADA TRIFÁSICA**

CALHA SALIENTE EUTRAC®	613
ACESSÓRIOS DA CALHA SALIENTE EUTRAC®	615
CALHA DE ENCASTRAR EUTRAC®	617
ACESSÓRIOS PARA CALHA ENCASTRADA EUTRAC®	617
CALHA SALIENTE S-TRACK DALI	605
ACESSÓRIOS CALHA SALIENTE S-TRACK DALI	607
CALHA ENCASTRADA S-TRACK DALI	609
ACESSÓRIOS PARA CALHA ENCASTRADA S-TRACK DALI	611

**CALHA ELETRIFICADA DE TENSÃO****REDUZIDA 48VDC**

CALHA SALIENTE 48V DALI	503
ACESSÓRIOS PARA CALHA SALIENTE 48V DALI	505
CALHA SALIENTE PROFUNDA 48V DALI	507
ACESSÓRIOS PARA CALHA SALIENTE PROFUNDA 48V DALI	509
CALHA PARA ENCASTRAR 48V DALI	511
ACESSÓRIOS PARA CALHA ENCASTRADA 48V DALI	513

**A**

ABRIDOR 100 POLE	797
ABRIDOR 100 POLE 100, HYBRID	796
ABRIDOR 60 POLE	797
ABRIDOR 60 POLE, HYBRID	796
ABRIDOR SENSOR WL	915
ABRIDOR WL	915
ABRIDOR WL, HYBRID	913
ADEGAN FL, E27	775
ADEGAN FL, FLAT SOLAR	717
ADEGAN FL, SOLAR	717
ADI EL	950
AINOS CW	942
AINOS CW SENSOR	943
AINOS CW SENSOR, QUADRADO	943
AINOS CW, QUADRADO	943
AKALO D83 EL	155
ALPA CONE 100 POLE, E27	777
ALPA MUSHROOM 45 POLE, E27	777
ALPA MUSHROOM 75 POLE, E27	777
ALTRA DICE CL, QPAR51	203
ALTRA DICE CW, DOUBLE, QPAR51	203, 456
ALTRA DICE TRACK MONOF., QPAR51	599
ALTRA DICE TRACK TRIF., QPAR51	658
ANELA CL, PHASE	199
ANELA PD, PHASE	310
ANGOLUX SENSOR WL	902
ANGOLUX WL	902
APONI 120 POLE, PHASE	778
APONI 90 POLE, PHASE	778
ARLINA 130 WL	361
ARLINA 60 WL	361
ARROCK ARC POLE, QPAR51	760
ARROCK GRANITE 40 POLE, SQUARE, E27	759
ARROCK GRANITE 70 POLE, SQUARE, E27	759
ARROCK SLOT POLE, QPAR51	761
ARROCK STONE 50 POLE	761
ARROCK STONE 75 POLE	761
ASMARA LV, QR-C51	544
ASSO 300 WL, PHASE	396, 397
ASTINA CL, QPAR51	198
ASTINA PD, QPAR51	309
ASTINA STEEL WL, QPAR51	899
ASTINA UP/DOWN WL, QPAR51	407

ASTINA WL, QPAR51	899
ASTO CW, DOUBLE, QPAR51	435
ASTO CW, QUAD, QPAR51	435
ASTO CW, SINGLE, QPAR51	435
ASTO CW, TRIPLE, QPAR51	435
ASTO TUBE	287, 443
ASTO TUBE MONOF., GU10	585
ASTO TUBE CL, SINGLE, GU10	201
ASTO TUBE CW, DOUBLE, GU10	443
ASTO TUBE CW, QUADRUPL, GU10	443
ASTO TUBE CW, SINGLE, GU10	443
ASTO TUBE CW, TRIPLE, GU10	443
ASTO TUBE	
REFLETOR DECORATIVO	201, 287, 375, 443, 585
ASTO TUBE PD, DOUBLE, GU 10	287
ASTO TUBE PD, QUADRUPLE, GU 10	287
ASTO TUBE PD, SINGLE, GU 10	287
ASTO TUBE PD, TRIPLE, GU 10	287
ASTO TUBE WL, SINGLE, GU10	375
ASTO TUBE WL, UP/DOWN, GU10	375
AVO CW, DOUBLE, QPAR51	433
AVO CW, QUAD, QPAR51	433
AVO CW, SINGLE, QPAR51	433
AVO CW, TRIPLE, QPAR51	433
AVO TRACK MONOF., QPAR51	593
AVO TRACK TRIF., QPAR51	665

**ACESSÓRIOS**

BRAÇADEIRA DE CABOS	1057
CABO TÊXTEL 10 M	1057
CAIXA DE DERIVAÇÃO EM T IP68, 3 PINOS	1058
CAIXA DE LIGAÇÃO IP68, 3 PINOS	1058
CAIXA DE LIGAÇÃO IP68, 5 PINOS	1058
CONNECTION BOX 5 POLES, DALI	1058
CONTROLADOR DT8 COM FUNÇÃO PUSH-DIM	1056
CONTROLADOR LED 10,7W   200MA   DALI REGULÁVEL	1055
CONTROLADOR LED 10W   180-270MA PHASE	1051
CONTROLADOR LED 10W   350MA REDONDO	1050
CONTROLADOR LED 10W   500-700MA PHASE	1052
CONTROLADOR LED 12W   250MA DALI REGULÁVEL COM INTERFACE RF	1055
CONTROLADOR LED 15W   100-700MA DALI	1053
CONTROLADOR LED 15W   200-350MA PHASE	1053
CONTROLADOR LED 15W   700MA REDONDO	1051
CONTROLADOR LED 20W   350-500MA PHASE	1053
CONTROLADOR LED 20W   350MA	1051
CONTROLADOR LED 20W   350MA   REGULÁVEL	1051
CONTROLADOR LED 20W   350MA/500MA   PHASE	1051
CONTROLADOR LED 21W   500MA INCL. ALÍVIO DE TENSÃO	1051
CONTROLADOR LED 25W   150-700MA   DALI REGULÁVEL	1053
CONTROLADOR LED 30W   500-700MA PHASE	1053
CONTROLADOR LED 36W   100-900MA DALI	1054
CONTROLADOR LED 3W   100-700MA DALI	1054
CONTROLADOR LED 40W   1050MA DALI CCT TUNABLE	1055
CONTROLADOR LED 40W   1050MA DALI REGULÁVEL COM INTERFACE RF	1055
CONTROLADOR LED 40W   500MA DALI REGULÁVEL COM INTERFACE RF	1055

CONTROLADOR LED 40W   700-1050MA PHASE	1053
CONTROLADOR LED 40W   700MA DALI REGULÁVEL COM INTERFACE RF	1055
CONTROLADOR LED 4W   350MA	1050
CONTROLADOR LED 4W   700MA	1050
CONTROLADOR LED 53W   650-1400MA DALI	1054
CONTROLADOR LED STIP CCT / RGBW	1047
CONVERSOR DE REGULADOR DE CORTE DE FASE INVERSA	1046
DALI INTERFACE 1-10V + ON/OFF	1046
DALI KONTROLER 24V DC	1047
DALI UNIVERSAL DIMMER 10-300W	1047
DRIVER DE ALÍVIO DE TENSÃO PADRÃO	1054
DRIVER DE ALÍVIO DE TENSÃO POR CABO	1054
E-TRANSFORMADOR 60W   12V REGULÁVEL	1046
ELEMENTO DE LUZ DE EMERGÊNCIA DALI 2	1056
FONTE DE ALIMENTAÇÃO LED 100W   24V   2 KANAL DALI REGULÁVEL	1050
FONTE DE ALIMENTAÇÃO LED 100W   24V DC	1049
FONTE DE ALIMENTAÇÃO LED 100W   24V DC DALI REGULÁVEL INCL. ALÍVIO DE TENSÃO	1049
FONTE DE ALIMENTAÇÃO LED 100W   24V DC INCL. ALÍVIO DE TENSÃO	1048
FONTE DE ALIMENTAÇÃO LED 12V   24W, REDONDO	1048
FONTE DE ALIMENTAÇÃO LED 150W   24V DC DALI REGULÁVEL INCL. ALÍVIO DE TENSÃO	1049
FONTE DE ALIMENTAÇÃO LED 150W   24V DC INCL. ALÍVIO DE TENSÃO	1048
FONTE DE ALIMENTAÇÃO LED 24V   24W	1047
FONTE DE ALIMENTAÇÃO LED 24V   25W, REDONDO	1048
FONTE DE ALIMENTAÇÃO LED 24V   36W	1047
FONTE DE ALIMENTAÇÃO LED 24V   60W	1047
FONTE DE ALIMENTAÇÃO LED 250W   24V DC DALI REGULÁVEL INCL. ALÍVIO DE TENSÃO	1050
FONTE DE ALIMENTAÇÃO LED 250W   24V DC INCL. ALÍVIO DE TENSÃO	1048
FONTE DE ALIMENTAÇÃO LED 25W   24V	1049
FONTE DE ALIMENTAÇÃO LED 30W   24V DC DALI REGULÁVEL INCL. ALÍVIO DE TENSÃO	1049
FONTE DE ALIMENTAÇÃO LED 30W   24V DC INCL. ALÍVIO DE TENSÃO	1048
FONTE DE ALIMENTAÇÃO LED 30W   24V DC DALI REGULÁVEL INCL. ALÍVIO DE TENSÃO	1049
FONTE DE ALIMENTAÇÃO LED 60W   DALI, 24V, 2 CANAIS DALI REGULÁVEL	1050
GANCHO PARA TETO	1057
GLENOS®	1057
GU10 CASQUILHO	1058
GU10 CONNECTION BOX COM BASE, UNIVERSAL	1057
GU10 LED CONNECTION BOX COM BASE, MÁX. 10 W	1057
MÓDULO CASAMBI PARA CONTROLADOR DALI	1056
MÓDULO ZIGBEE PARA CONTROLADOR DALI, 1 CANAL	1056
MÓDULO ZIGBEE PARA CONTROLADOR DALI, 2 CANAIS	1056
TELECOMANDO SMART ZIGBEE, CCT/RGBW	1056
TRANSFORMADOR TENSEO 12V AC   105VA CONVENCIONAL	1046
TRANSFORMADOR TENSEO 12V AC   210VA CONVENCIONAL	1046
TRANSFORMADOR TENSEO 12V AC   50VA CONVENCIONAL	1046

**B**

BASKET WL, E27	402
----------------	-----

BATTEN 120 CW	471
BATTEN 60 CW	471
BIG NAILS 50 POLE, E27	780
BIG NAILS 80 POLE, E27	780
BIG NAUTILUS SP, REDONDO, QPAR51	810
BIG PLOT COBERTURA, 2 PEÇAS	983
BIG PLOT COBERTURA, 4 PEÇAS	983
BIG PLOT MÓDULOS	983
BIG QUAD UP/DOWN WL	891
BIG QUAD WL	890
BIG THEO BEAM UP/FLOOD DOWN WL	861
BIG THEO CL	833
BIG THEO CL, QPAR111	833
BIG THEO FLOOD UP/DOWN WL	862
BIG THEO UP/DOWN WL, QPAR111	861
BIG THEO WL	863
BIG THEO WL, QPAR111	863
BIMA MONOF., DOUBLE, QPAR51	597
BIMA MONOF., SINGLE, QPAR51	597
BIMA TRIF., DOUBLE, QPAR51	663
BIMA TRIF., SINGLE, QPAR51	663
BOOKAT POLE	800
BOOKAT WL	889
BOX UP/DOWN WL, QT-DE12	919
BOX-L WL	919
BOX-L WL, E27	919
BRICK DOWNUNDER EL	955
BRICK DOWNUNDER EL, E14	955
BRICK EL, ASSIMÉTRICO	953
BRICK EL, SIMÉTRICO	953
BRICK MESH EL	953
BULAN CW, E14	945
BULAN GRID CW, E27	945
BULKHEAD V 360	1027

## C

C-POL POLE, E27	784
CARISO WL, PHASE	398
CHROMBO WL, PHASE	399
COMET LED LV	549
COMET LV, QR-C51	549
CONCRETO EL, CUT	949
CONCRETO EL, WING	949
CONCRETO FL, QUADRADO, QPAR51	733
CONCRETO FL, REDONDO, QPAR 51	733
CONCRETO L WL	855
CONCRETO M WL	855
CONE FL, E27	772
CONTONE® DL, REDONDO, RÍGIDO, PHASE	149
CONTONE® DL, REDONDO, REGULÁVEL, PHASE	149
COSMIC LV, QR-C51	545
COUPA FLEX WL	409
CUBIX FL, QPAR51	772
CYFT CW, PHASE	439
CYFT ANEL DECORATIVO	439
CYFT WAVE CW, PHASE	439

## D

D-RING M WL, PHASE	851
D-RING S WL, PHASE	851
DASAR® 115 RL, QUADRADO, QPAR51	973
DASAR® 115 RL, REDONDO, QPAR51	973
DASAR® 1200 EL	959
DASAR® 215 RL, QUADRADO, QPAR111	977
DASAR® 215 RL, REDONDO, E27	977
DASAR® 215 RL, REDONDO, QPAR111	976
DASAR® 255 EL	969
DASAR® 270 EL, ASSIMÉTRICO	971
DASAR® 270 EL, SIMÉTRICO	971
DASAR® 370 EL, REDONDO	977
DASAR® 600 EL	959
DASAR® 920 EL	970
DASAR® 920 SP, 230V	815

DASAR® EXACT 116 EL, QUADRADO, QPAR51	975
DASAR® EXACT 116 EL, REDONDO, QPAR51	975
DASAR® FLAT 120 EL	969
DASAR® FLAT 80 EL	969
DASAR® L RL, QUADRADO	965
DASAR® L RL, REDONDO	965
DASAR® M RL, QUADRADO	963
DASAR® M RL, REDONDO	962
DASAR® PROJECTOR SP, 12/24V	815
DASAR® S RL, QUADRADO	961
DASAR® S RL, REDONDO	961
DASAR® XL RL, QUADRADO	967
DASAR® XL RL, REDONDO	966
DECONA 30 CW, PHASE	418
DECONA 42 CW, PHASE	419
DEKLED EL	152
DELWA WL	907
DENA 30 WL, E14	402
DIO FLEX PLATE WL	415
DIO FLEX PLATE WL QPAR51	415
DIRETO 60 WL, PHASE	401
DIRETO 90 WL, PHASE	401
DISPLAY ADL 50 QPAR51	417
DL 126 EL	145
DOLIX OUT EL, QUADRADO, QPAR51	153
DOLIX OUT EL, REDONDO, QPAR51	153
DORISA 30 WL	367
DORISA 50 WL	367
DOWNLIGHT C 150	1005, 1006
DOWNLIGHT C 200	1005, 1007
DOWNLIGHT V 100	1008
DOWNLIGHT V 150	1008
DOWNLIGHT V 200	1008
DOWNUNDER OUT L EL	951
DOWNUNDER OUT M EL	951
DOWNUNDER OUT S EL	951
DOWNUNDER OUT WL, QUADRADO	911
DOWNUNDER OUT WL, REDONDO	911
DOWNUNDER PUR 150 EL	160
DOWNUNDER PUR 80 EL	160
DURNO LV	547

## E

ENOLA S/M/L REFLETOR	873
ENOLA B MONOF., PD, QPAR51	595
ENOLA B CL, QPAR51	197
ENOLA B CW, DOUBLE, QPAR51	455
ENOLA B CW, SINGLE, QPAR51	455
ENOLA B PD, QPAR51	309
ENOLA B TRACK MONOF., QPAR51	595
ENOLA B WL, QPAR51	407
ENOLA C CL	197
ENOLA C TRACK MONOF.	594
ENOLA C TRACK TRIF.	665
ENOLA M LINSE 19°	873
ENOLA M LINSE ASSIMÉTRICO	873
ENOLA OCULUS CL	828
ENOLA OCULUS WL, SINGLE	865
ENOLA OCULUS WL, UP/DOWN	865
ENOLA PD, E27	309
ENOLA ROUND L CL	829
ENOLA ROUND L UP/DOWN WL	869
ENOLA ROUND L WL, SINGLE	867
ENOLA ROUND M CL	829
ENOLA ROUND M UP/DOWN WL	869
ENOLA ROUND M WL, SINGLE	867
ENOLA ROUND S CL	829
ENOLA ROUND S UP/DOWN WL	869
ENOLA ROUND S WL, SINGLE	867
ENOLA SQUARE L CL	831
ENOLA SQUARE L UP/DOWN WL	872
ENOLA SQUARE L WL, SINGLE	871
ENOLA SQUARE M CL	831
ENOLA SQUARE M UP/DOWN WL	872
ENOLA SQUARE M WL, SINGLE	871

ENOLA SQUARE S CL	831
ENOLA SQUARE S UP/DOWN WL	872
ENOLA SQUARE S WL, SINGLE	871
ESKINA 30 POLE	739
ESKINA 80 POLE	739
ESKINA D DISPLAY, PHASE	929
ESKINA FRAME 125 POLE, DOUBLE	738
ESKINA FRAME 175 POLE, DOUBLE	738
ESKINA FRAME 45 POLE, SINGLE	737
ESKINA FRAME 75 POLE, DOUBLE	737
ESKINA FRAME 75 POLE, SINGLE	737
ESKINA FRAME CL, SINGLE	827
ESKINA FRAME WL	887
ESKINA FRAME WL, DOUBLE	887
ESKINA SPOT CW, PHASE	937
ESKINA SPOT SENSOR CW, PHASE	937
EURO CUBE	658
EURO SPOT TRACK MONOF., QPAR51	659
EURO SPOT TRACK TRIF., QPAR111	659
EURO SPOT TRACK TRIF., QPAR51	659

## F

F-POL POLE, E27	784
F-POL WL, E27	924
FENDA 15 CM, REDONDO	300, 497
FENDA 30 CM, REDONDO	301, 497
FENDA ROSETA PARA TETO, E27	206
FENDA FL, E27	495, 497
FENDA DIFUSOR EM VIDRO 12,5 CM, REDONDO	300
FENDA ABAJUR	408
FENDA Ø 30 CM, REDONDO	207
FENDA Ø 45 CM, REDONDO	207, 301, 497
FENDA Ø 70 CM, REDONDO	301
FENDA Ø 70CM, REDONDO	207, 497
FENDA PD, E27	300
FENDA TL, E27	495
FENDA WL, BASIS, E27	408
FERA 25 CL	212
FERA 25 CL, DALI	212
FITU CUBE WL, E27	404
FITU PD, E27	299
FITU HASTE DE SUPORTE PARA PAREDE	404
FLAC BEAM® SP	809
FLATT 100 POLE	793
FLATT 65 POLE	793
FLATT SENSOR WL	898
FLATT WL	898
FLOODI L SP	1029
FLOODI M SP	1029
FLOODI S SP	1029
FORCHINI 50 PD, E27	316
FORCHINI 70 PD, E27	316
FORCHINI M 40 PD, E27	317
FORCHINI M 40 TRACK MONOF., PD, E27	561
FORCHINI M 40 TRACK TRIF., PD, E27	655
FORCHINI M 50 PD, E27	317
FRAME BASIC RL	156
FRAME BASIC RL, HV	156
FRAME BASIC SET RL	156
FRAME CURVE EL	157

## G

GALEN 120 SP	808
GALEN 60 SP	808
GLENOS PD, 1M, 1-10V	293
GLENOS PD, 2M, 1-10V	293
GLENOS® 60 WL	367
GLOO PURE 27 POLE, E27	767
GLOO PURE 44 POLE, E27	767
GLOO PURE 70 POLE, E27	767
GLOO PURE WL, E27	923
GRAFIT 30 POLE, E27	747
GRAFIT 30 POLE, REDONDO, E27	745
GRAFIT 60 POLE, E27	747

GRAFIT 60 POLE, REDONDO, E27	745	HORN MAGNA EL	139	L-LINE OUT WL	921
GRAFIT 90 POLE, E27	747	HORN MINI EL	136	LALU® CONE 15 ABAJUR,	
GRAFIT 90 POLE, REDONDO, E27	745	HORN-T EL, QPAR111	139	MIX&MATCH	260, 535
GRAFIT WL, E27	881			LALU® ELYPSE 15 ABAJUR,	
GRAFIT WL, QUADRADO, SENSOR, E27	881	<b>I</b>		MIX&MATCH	261, 535
GRAFIT WL, REDONDO, E27	880	I-RING POLE	718	LALU® ELYPSE 22 ABAJUR,	
GRAFIT WL, REDONDO, SENSOR, E27	880	I-RING WL	852	MIX&MATCH	261, 535
GRAZIA 10 PERFIL SALIENTE, LISO 2 M	671	IN-LINE 22 48V,		LALU® ELYPSE 33 ABAJUR,	
GRAZIA 10 PERFIL SALIENTE, PADRÃO	671	DARKLIGHT REFLECTOR, DALI	523	MIX&MATCH	261
GRAZIA 10 ACESSÓRIOS	673	IN-LINE 22 48V, OPAL, DALI	523	LALU® ABAJUR, E27 BASE,	
GRAZIA 10 EDGE 2 M	674	IN-LINE 24 48V, MOVE,		MIX&MATCH	257
GRAZIA 10 PERFIL DE ENCASTRAR	671	DARKLIGHT REFLECTOR, DALI	527	LALU® PD 48V, LED BASE, MIX&MATCH	533
GRAZIA 10 EDGE ACESSÓRIOS	675	IN-LINE 44 48V,		LALU® PD, E27	257
GRAZIA 20 PERFIL SALIENTE, PADRÃO, 3 M	677	DARKLIGHT REFLECTOR, DALI	525	LALU® PD, LED BASE, MIX&MATCH	258, 259
GRAZIA 20 PERFIL DE ENCASTRAR, 3 M	677	IN-LINE 44 48V, OPAL, DALI	525	LALU® PLATE 15 ABAJUR,	
GRAZIA 20 ACESSÓRIOS	678, 679	IN-LINE 46 48V, MOVE,		MIX&MATCH	260, 535
GRAZIA 60 PERFIL SALIENTE, 1,5 M	681	DARKLIGHT REFLECTOR, DALI	527	LALU® PLATE 22 ABAJUR,	
GRAZIA 60 PERFIL DE ENCASTRAR, 1,5 M	681	INDA CW, QPAR51	457	MIX&MATCH	260, 535
GRAZIA 60 ACESSÓRIOS	682, 683	INDUSTRY BATTEN V	1018, 1019	LALU® TETRA 14 ABAJUR,	
GRAZIA IP FLEXSTRIP 24V	694	IPERI 50 POLE	798	MIX&MATCH	260, 534
GRAZIA IP FLEXSTRIP RGBW, 24V	695	IPERI WL	926	LALU® TETRA 24 ABAJUR,	
GRAZIA IP FLEXSTRIP TUNABLE WHITE, 24V	695			MIX&MATCH	260, 534
GRAZIA LED STRIP		<b>K</b>		LALU® TETRA 36 ABAJUR,	
CORE MAIN LIGHTING, 2700K	689	KADUX DL, DOUBLE, DALI	063	MIX&MATCH	260
GRAZIA LED STRIP		KADUX DL, DOUBLE, PHASE	065	LED CONNECTION BOX COM BASE,	
VALUE ADDITIONAL LIGHTING, 2700K	686	KADUX DL, SINGLE, DALI	062	MÁX. 10 W	118
GRAZIA LED STRIP		KADUX DL, SINGLE, PHASE	065	LED SPIKE SP	819
VALUE MAIN LIGHTING +, 3000K	688	KADUX DL, TRIPLE, PHASE	065	LED SPOT SP	931
GRAZIA LED STRIP		KADUX EL, DOUBLE, QPAR111	067	LID I 45 POLE, SINGLE	719
VALUE MAIN LIGHTING, 2700K	687	KADUX EL, DOUBLE, QPAR51	066	LID I 75 POLE, DOUBLE	719
GRAZIA PRO FLEXSTRIP RGBW, 24V	693	KADUX EL, SINGLE, QPAR111	067	LID I WL, DOUBLE	846
GRAZIA PRO FLEXSTRIP		KADUX EL, SINGLE, QPAR51	066	LID I WL, SINGLE	846
TUNABLE WHITE, 24V	692	KADUX EL, TRIPLE, QPAR51	066	LID II	847
GRAZIA PRO MAX FLEXSTRIP 24V	690, 691	KALU CW, DOUBLE, PHASE	451	LID II WL, UP/DOWN	847
GRID CUBE	701	KALU CW, DOUBLE, QPAR111	453	LIGHT EYE® 150 MONOF., PD, QPAR111	579
GRIP! L MONOF., PD, QPAR51, Ø 5,7 CM	573	KALU CW, QUAD, PHASE	451	LIGHT EYE® 150 MONOF., QPAR111	577
GRIP! L MONOF., QPAR51, Ø 5,7 CM	573	KALU CW, QUAD, QPAR111	453	LIGHT EYE® 150 TRIF., PD, QPAR111	657
GRIP! L TRIF., QPAR51, Ø 5,7 CM	627	KALU CW, SINGLE, PHASE	451	LIGHT EYE® 150 TRIF., QPAR111	657
GRIP! L ANEL DECORATIVO Ø 5,4 CM	575, 627	KALU CW, SINGLE, QPAR111	453	LIGHT EYE® 150 ANEL	
GRIP! M MONOF., PHASE, Ø 4,3 CM	571	KALU CW, TRIPLE, PHASE	451	DECORATIVO	285, 579, 657
GRIP! M TRIF., DALI, Ø 4,3 CM	624	KALU CW, TRIPLE, QPAR111	453	LIGHT EYE® 150 PD, QPAR111	285
GRIP! M TRIF., PHASE, Ø 4,3 CM	625	KALU TRACK MONOF., PHASE	581	LIGHT EYE® 90 MONOF., PD, QPAR51	579
GRIP! M ANEL DECORATIVO Ø 4,0 CM	575, 627	KALU TRACK MONOF., QPAR111	581	LIGHT EYE® 90 MONOF., QPAR51	576
GRIP! S MONOF.	569	KALU TRACK TRIF., PHASE	662	LIGHT EYE® 90 TRIF., PD, QPAR51	656
GRIP! S MONOF., PHASE, Ø 3,0 CM	569	KALU TRACK TRIF., QPAR111	662	LIGHT EYE® 90 ANEL	
GRIP! S 48V, DALI, Ø 3,0 CM	529	KAMI CL, DOUBLE, LONG, QPAR51	171	DECORATIVO	285, 579, 657
GRIP! S 48V, PD, DALI, Ø 3,0 CM	531	KAMI CL, DOUBLE, QPAR51	171	LIGHT EYE® 90 PD, QPAR51	285
GRIP! S ANEL DECORATIVO Ø 2,7 CM	575	KAMI CL, SINGLE, QPAR51	170	LIPSY® 30 CW, DOME	465
GU10 LED CONNECTION BOX	118	KAMI CL, TRIPLE, LONG, QPAR51	171	LIPSY® 30 CW, DRUM	467
		KAMI CW, SINGLE, QPAR51	441	LIPSY® 40 CW, DOME	465
		KAMI RL, SINGLE, QPAR51	057	LIPSY® 40 CW, DRUM	467
		KAMUELA ECO EL, REDONDO, PHASE	155	LIPSY® 40 CW, DRUM, DALI	468
		KARDAMOD CL, DOUBLE, QUADRADO,		LIPSY® 50 CW, DOME	465
		QPAR111	205	LIPSY® 50 CW, DRUM	467
		KARDAMOD CL, SINGLE, QUADRADO,		LIPSY® 50 CW, DRUM, DALI	468
		QPAR111	205	LISENNE 40 POLE, E27	774
		KARPO 30 CW, SINGLE	445	LISENNE 70 POLE, E27	774
		KARPO 30 EL	150	LITTLE SUN TL	491
		KARPO 30 WL, SINGLE	411	LOGS 40 POLE	743
		KARPO FL	498	LOGS 70 POLE	743
		KARPO GOOSE WL	410	LOGS IN L WL, PHASE	393
		KARPO MAGN CW, SINGLE, PHASE	410	LOGS IN WL	392
		KARPO TL	498	LOGS IN WL, PHASE	392
		KARPO WL	411	LOGS WL	921
		KENKUA SPOT WL, E27	409	LONG GRILL CW	473
		KERAS ELT WL, E27	925	LYGANT WL, DOUBLE	331
		KINI EL, PHASE	155	LYGANT WL, SINGLE	331
		<b>L</b>		<b>LÂMPADA</b>	
		L-LINE 60 WL	369	LED A19 SOFT CAGE E27	1039
		L-LINE 120 WL	369	LED A60 E27	1039
		L-LINE OUT 30 FL, VERTICAL	762	LED A60 E27 CLEAR FILAMENT	1039
		L-LINE OUT 50 POLE, HORIZONTAL	763	LED A60 E27 CLEAR FILAMENT	
		L-LINE OUT 60 FL, VERTICAL	763	HIGH EFFICIENCY	1039
		L-LINE OUT 80 POLE, HORIZONTAL	763	LED A60 E27, MIRRORHEAD, CHROM	1043

LED A60 E27, RGBW, SMART	1039
LED A60 E27, TUNABLE 2700-6500K, SMART	1038
LED A60 GU10	1035
LED BULB SOFT CAGE A19 E27	1041
LED C35 E14 GOLD CURLY FILAMENT	1034
LED C35 E14	1035
LED CANDLE G9	1034
LED FLOATING GLOBE 125 E27	1040
LED FLOATING GLOBE 150 E27	1040
LED FLOATING GLOBE 200 E27	1041
LED FLOATING GLOBE 300 E27	1041
LED G125 E27	1043
LED G45 E14 GOLD CURLY FILAMENT	1034
LED GLOBE 125	
HALF MOON FROSTED, E27	1043
LED GLOBE 125 ILLUSION, CRESCENT SLANTING, E27	1040
LED GLOBE 125 ILLUSION, SLANTING TOP, E27	1040
LED GLOBE 125 ILLUSION, TWO CRESCENT, E27	1040
LED GU10	1036
LED QPAR111 GU10	1037, 1038
LED QPAR51 GU10	1036
LED QR51 GU.5.3	1035
LED QT-DE12 R7S, 118 MM	1034
LED QT-DE12 R7S, 78 MM	1034
LED QT14 G9	1034
LED RUSTIKA SOFT CAGE E27	1042
LED SOFT TUBE T300 E27	1041
LED ST58 E27	1042
LED ST64 E27	1042
LED ST64 E27 GOLD CURLY FILAMENT	1042
LED T32 FILAMENT GU10 BULB GU10	1036
LED T38 E27	1041
LED T45 E27	1042
LED TCR-TSE GX53	1035
LED TUBE C T5 EM 1200 26W	1031
LED TUBE C T5 EM 1500 34W	1031
LED TUBE C T8 EM 1200 16W	1031
LED TUBE C T8 EM 1500 24W	1031
LED TUBE HIGH BRIGHTNESS, E27	1042
LED TUBE SOFT SPIRAL E27	1041
LED TUBE V T8 EM 1200 16W	1031
LED TUBE V T8 EM 1500 22W	1031

**M**

M-POL 30 POLE	729
M-POL 60 POLE	729
M-POL 90 POLE	729
M-POL CAP	728
M-POL M POLEHEAD	725
M-POL M POLEHEAD, DALI	725
M-POL M POLEHEAD, LOUVER	727
M-POL M POLEHEAD, LOUVER, DALI	727
M-POL M POLEHEAD, SHADER	726
M-POL M POLEHEAD, SHADER, DALI	726
M-POL POLE 60, SOCKET	728
M-POL S POLEHEAD	722
M-POL S POLEHEAD 180°, OFUSCAMENTO ELIMINADO	721
M-POL S POLEHEAD 180°, OFUSCAMENTO ELIMINADO, DALI	721
M-POL S POLEHEAD 360°, OFUSCAMENTO ELIMINADO	720
M-POL S POLEHEAD 360°, OFUSCAMENTO ELIMINADO, DALI	720
M-POL S POLEHEAD, DALI	723
M-POL S POLEHEAD, LOUVER	724
M-POL S POLEHEAD, LOUVER, DALI	724
M-POL S POLEHEAD, SHADER	723
M-POL S POLEHEAD, SHADER, DALI	723
MAGANDA WL	365

MAGICO 20 PD, E27	231
MAGICO 38 PD, E27	231
MAGICO 55 PD, E27	231
MANA 40 ABAJUR, REDONDO	379
MANA 40 ABAJUR, REDONDO, FELTRO ACÚSTICO	378
MANA 40 ABAJUR, REDONDO, MOON STRUCTURE	379
MANA 60 ABAJUR, REDONDO	379
MANA 60 ABAJUR, REDONDO, FELTRO ACÚSTICO	378
MANA 60 ABAJUR, REDONDO, ESTRUCTURA LUNAR	379
MANA BASE REDONDO	378
MANA BASE WL, REDONDO, PHASE	377, 858
MANA OUT WL, PHASE	859
MANA OUT WL, CONJUNTO	859
MANA ABAJUR	383
MANA WL, BASIS, PHASE	381, 383
MARONA CL, PHASE	213
MARYLIN 40 WL	363
MARYLIN 60 WL	363
MARYLIN 90 WL	363
MEDO® 30 CW, PHASE	250, 352
MEDO® 30 RL, FRAME	132
MEDO® 30 RL, FRAMELESS	134
MEDO® 40 CW, PHASE	250, 352
MEDO® 40 RL, FRAME	132
MEDO® 40 RL, FRAMELESS	134
MEDO® 60 CW, PHASE	251, 353
MEDO® 60 RL, FRAME	133
MEDO® 60 RL, FRAMELESS	135
MEDO® 90 CW, PHASE	251, 353
MEDO® 90 RL, FRAME	133
MEDO® 90 RL, FRAMELESS	135
MEDO® CL, CUADRADO, 1-10V	191, 253
MEDO® CL, CUADRADO, DALI	191, 253
MEDO® PRO 30 CW, DALI	246, 348
MEDO® PRO 30 CW, DALI, UGR<19	242, 344
MEDO® PRO 30 CW, PHASE	246, 348
MEDO® PRO 30 CW, PHASE, UGR<19	242, 344
MEDO® PRO 40 CW, DALI	247, 349
MEDO® PRO 40 CW, DALI, UGR<19	243, 345
MEDO® PRO 40 CW, PHASE	247, 349
MEDO® PRO 40 CW, PHASE, UGR<19	243, 345
MEDO® PRO 60 CW, DALI	248, 350
MEDO® PRO 60 CW, DALI, UGR<19	244, 346
MEDO® PRO 60 CW, PHASE	248, 350
MEDO® PRO 60 CW, PHASE, UGR<19	244, 346
MEDO® PRO 90 CW, DALI	249, 351
MEDO® PRO 90 CW, DALI, UGR<19	245, 347
MEDO® PRO 90 CW, PHASE	249, 351
MEDO® PRO 90 CW, PHASE, UGR<19	245, 347
MEDO® RING 60 PD, DALI	240
MEDO® RING 60 PD, PHASE	241
MEDO® RING 90 PD, DALI	241
MEDO® RING 90 PD, PHASE	241
MELAN CW, E27	469
MERADO FLOOD WL, PHASE	416
MERIDIAN BOX SENSOR WL, E27	885
MERIDIAN BOX WL, E27	884, 885
MERIDIAN WL, E27	884
MIBO UP/DOWN WL, QT14	365
MOBALA EL	161
MODELA WL, UP/DOWN	901
MOLAT CL, E27	834
MOLAT PD, E27	773
MOLAT POLE, E27	773
MOLAT WL, E27	923
MYRA CW, SINGLE, QPAR51	931
MYRA DISPLAY WL, CURVED, QPAR51	929
MYRA SPOT DOUBLE, GU10	801
MYRA UP/DOWN WL, QPAR51	904
MYRA WL, DOUBLE, QPAR51	941

**N**

NAUTILUS 10 SP, CUADRADO	812
NAUTILUS 10 SP, REDONDO, QPAR51	810, 811
NAUTILUS 10 SPOT LED SP	813
NAUTILUS 10 SPOT SP, QPAR51	813
NAUTILUS SP, QR-C51	813
NAUTILUS WL QPAR51	931
NEW TRIA® 150 DL, CUADRADO, QPAR111	131
NEW TRIA® 150 DL, REDONDO, QPAR111	131
NEW TRIA® 155 DL, DOUBLE	117
NEW TRIA® 155 DL, DOUBLE, QPAR51	116
NEW TRIA® 155 RING, DOUBLE, SQUARE	
GU10/LED MÓDULOS	127
NEW TRIA® 300 DL, DOUBLE, QPAR111	131
NEW TRIA® 45 DL, REDONDO	130
NEW TRIA® 68 DL, DTW, PHASE	108
NEW TRIA® 68 DL, PHASE	104, 106
NEW TRIA® 68 DL, QPAR51	112
NEW TRIA® 68 RING, CUADRADO, GU10/MÓDULOS LED	121
NEW TRIA® 68 RING, CUADRADO, GU10/MÓDULOS LED	120, 121
NEW TRIA® 68 RING, REDONDO, GU10/MÓDULOS LED	121
NEW TRIA® 68 RING, REDONDO, GU10/MÓDULOS LED	120, 121
NEW TRIA® 75 / XL DL, QPAR51	114
NEW TRIA® 75 DL, REDONDO, PHASE	106
NEW TRIA® 75 RING, CUADRADO, GU10/MÓDULOS LED	122
NEW TRIA® 75 RING, REDONDO, GU10/MÓDULOS LED	122
NEW TRIA® 75 RING, REDONDO, GU10/MÓDULOS LED	122
NEW TRIA® 75 RING, REDONDO, GU10/MÓDULOS LED	122
NEW TRIA® 75 XL RING, REDONDO, GU10/MÓDULOS LED	123
NEW TRIA® 95 RING, CUADRADO, GU10/MÓDULOS LED	125
NEW TRIA® 95 RING, REDONDO, MÓDULOS LED	125
NEW TRIA® DL, DOUBLE MÓDULO LED, PHASE	127
NEW TRIA® DL, MÓDULO LED, DTW, PHASE	119
NEW TRIA® DL, MÓDULO LED, PHASE	119, 125
NEW TRIA® UNIVERSAL 68 DL, PHASE	110
NEW TRIA® UNIVERSAL DL, MÓDULO LED, PHASE	119
NOBLO SPOT MONOF., PHASE	582, 583
NOBLO SPOT MONOF., TRIPLE TRACK SET	582
NOBLO SPOT TRIF., PHASE	644, 645
NOBLO SPOT LV, ROPE TRACK	549
NOBLO® CW DOUBLE, PHASE	449
NOBLO® CW DOUBLE, PHASE, DTW	447
NOBLO® CW SINGLE, PHASE	449
NOBLO® CW SINGLE, PHASE, DTW	447
NOBLO® CW TRIPLE, PHASE	449
NOBLO® CW TRIPLE, PHASE, DTW	447
NOTAPO L RL	159
NOTAPO S RL	159
NOYA PD, PHASE	292
NUMINOS® L PD	236
NUMINOS® GIMBLE L DL	094
NUMINOS® GIMBLE M DL	092
NUMINOS® GIMBLE S DL	090
NUMINOS® GIMBLE XL DL	096
NUMINOS® GIMBLE XS DL	088
NUMINOS® L TRIF.	632
NUMINOS® L CL	186
NUMINOS® L CW	340
NUMINOS® L DL	074
NUMINOS® M TRIF.	630
NUMINOS® M CL	184
NUMINOS® M CW	338
NUMINOS® M DL	072

NUMINOS® M PD _____	234	OUT-BEAM FRAME SP _____	941	PHOTONI WL, E27 _____	845
NUMINOS® MOVE L DL _____	084	OUT-BEAM UP/ FLOOD DOWN WL _____	921	PHOTONIA POLE, E27 _____	771
NUMINOS® MOVE M DL _____	082	OVAL 14 WL, UP/DOWN _____	853	PHOTONIA WL, E27 _____	923
NUMINOS® MOVE S DL _____	080	OVAL 18 WL, UP/DOWN _____	853	PIKA DL, REDONDO, QPAR51, ARTICULADA _____	146
NUMINOS® MOVE XL DL _____	086	OVALISK 100 POLE _____	765	PIKA DL, REDONDO, QPAR51, FIXA _____	146
NUMINOS® MOVE XS DL _____	078	OVALISK 75 POLE _____	765	PLASTRA 101 WL, E14 _____	391
NUMINOS® S TRIF. _____	628	OVALISK CL _____	833	PLASTRA 104 CL, E27 _____	211
NUMINOS® S 48V, DALI _____	516, 520	OVALISK SENSOR WL _____	895	PLASTRA 104 WL, QT14 _____	391
NUMINOS® S CL _____	182	OVALISK WL _____	895	PLASTRA 105 CL, E27 _____	211
NUMINOS® S CW _____	336			PLASTRA CL, PHASE _____	211
NUMINOS® S DL _____	070	<b>P</b>		PLASTRA CL, QPAR51 _____	210
NUMINOS® S PD _____	232	PANEL 60 CL, REDONDO, DALI _____	217	PLASTRA RL, CUADRADO, QPAR51 _____	151
NUMINOS® XL TRIF. _____	634	PANEL 60 CL, REDONDO, PHASE _____	217	PLASTRA RL, REDONDO, QPAR51 _____	151
NUMINOS® XL CL _____	188	PANEL 60 PD, REDONDO, DALI _____	291	PLASTRA WL, CUBE, QT14 _____	386
NUMINOS® XL CW _____	342	PANEL 600 ARO DE MONTAGEM, SALIENTE _____	997	PLASTRA WL, CUBES _____	386
NUMINOS® XL DL _____	076	PANEL 600 ARO DE MONTAGEM, ENCASTRADO _____	997	PLASTRA WL, CURVE, QT-DE12 _____	391
NUMINOS® XL PD _____	238	PANEL 625 ARO DE MONTAGEM, SALIENTE _____	999	PLASTRA WL, E14 _____	387
NUMINOS® XS 48V, DALI _____	514, 518	PANEL 625 ARO DE MONTAGEM, ENCASTRADO _____	999	PLASTRA WL, CUADRADO _____	389
NUMINOS® XS DL _____	068	PANEL C 600 _____	990	PLASTRA WL, SEMIRREDONDO _____	389
NUMINOS® ZOOM M TRIF. _____	636	PANEL C 625 _____	993	PLASTRA WL, QPAR51 _____	390
NUMINOS® ACESSÓRIOS _____	98-103	PANEL C 1200 _____	995	PLASTRA WL, RETANGULAR, QT-DE12 _____	387
		PANEL C DALI 600 _____	991	PLASTRA WL, SHIELD REDONDO _____	389
<b>O</b>		PANEL C DALI 625 _____	993	PLYTTA LV _____	548
OCCULDAS 13 CL, INDIRECTO, PHASE _____	202	PANEL C DALI 1200 _____	995	POWER TRAIL-LITE® EL, CUADRADO _____	979
OCCULDAS 14 EL, INDIRECTO, PHASE _____	148	PANEL TRACK MONOF., CUADRADO _____	589	POWER TRAIL-LITE® EL, REDONDO _____	979
OCCULDAS 23 CL, INDIRECTO, PHASE _____	202	PANEL TRACK MONOF., REDONDO _____	589	PURI 2.0 BASIC _____	426
OCCULDAS 23 EL, INDIRECTO, PHASE _____	148	PANEL V 600 _____	996, 997	PURI 2.0 BASIC MONOF., QPAR51 _____	566
OCULUS CL, DTW _____	195	PANEL V 625 _____	998, 999	PURI 2.0 BASIC TRIF., QPAR51 _____	622
OCULUS CL, MOVE, PHASE _____	147	PANEL V DALI 600 _____	997	PURI 2.0 BASIC CW, DOUBLE ASYM., QPAR51 _____	426
OCULUS CL, PHASE _____	196	PANEL V DALI 625 _____	999	PURI 2.0 BASIC CW, DOUBLE LONG, QPAR51 _____	427
OCULUS CW, PHASE _____	445	PANTILLO 20 PD, E27 _____	281	PURI 2.0 BASIC CW, CUADRUPLE LONG, QPAR51 _____	427
OCULUS PD, DTW _____	297	PANTILLO 28 PD, E27 _____	281	PURI 2.0 BASIC CW, INTERRUPTOR, SINGLE, QPAR51 _____	427
OCULUS PD, SINGLE, PHASE _____	296	PANTILLO CONVEX 29 PD, E27 _____	283	PURI 2.0 BASIC CW, SINGLE, QPAR51 _____	427
OCULUS WL UP/DOWN, DTW _____	385	PANTILLO CONVEX 40 PD, E27 _____	283	PURI 2.0 BASIC CW, SINGLE, QPAR51 _____	427
OCULUS WL UP/DOWN, PHASE _____	385	PANTILLO OVAL PD, E27 _____	281	PURI 2.0 BASIC CW, TRIPLE LONG, QPAR51 _____	427
ONE 40 CL, DALI, UP/DOWN _____	175	PANTILLO ROPE 19 CW, E27 _____	437	PURI 2.0 BASIC CW, TRIPLE ROUND, QPAR51 _____	427
ONE 40 CL, PHASE, UP/DOWN _____	173	PANTILLO ROPE 19 PD, E27 _____	279, 585	PURI 2.0 BASIC PD, MONOF., QPAR51 _____	567
ONE 40 CW, DALI _____	357	PANTILLO ROPE 20 PD, E27 _____	279	PURI 2.0 BASIC PD, TRIF., QPAR51 _____	623
ONE 40 TRACK TRIF., DALI _____	643	PANTILLO ROPE 27 CW, E27 _____	437	PURI 2.0 CONE _____	422
ONE 60 CL, DALI, UP/DOWN _____	175	PANTILLO ROPE 27 PD, E27 _____	279	PURI 2.0 CONE MONOF., QPAR51 _____	563
ONE 60 CL, PHASE, UP/DOWN _____	173	PANTILLO ROPE WL, G9 _____	373	PURI 2.0 CONE TRIF., QPAR51 _____	619
ONE 60 CW, DALI _____	357	PARA 380 PD, E27 _____	321	PURI 2.0 CONE CW, DOUBLE ASYM., QPAR51 _____	422
ONE BOW FL _____	483	PARA CONE 14 MONOF., GU10 _____	587	PURI 2.0 CONE CW, DOUBLE LONG, QPAR51 _____	423
ONE LINEAR 50 WL, PHASE, UP/DOWN _____	354	PARA CONE 14 MONOF., PD, GU10 _____	587	PURI 2.0 CONE CW, QUADRUPLE LONG, QPAR51 _____	423
ONE LINEAR 70 WL, PHASE, UP/DOWN _____	355	PARA CONE 14 TRIF., GU10 _____	651	PURI 2.0 CONE CW, INTERRUPTOR, SINGLE, QPAR51 _____	423
ONE STRAIGHT FL _____	483	PARA CONE 14 TRIF., PD, GU10 _____	651	PURI 2.0 CONE CW, SINGLE, QPAR51 _____	423
ONE® 60 PD, DALI _____	271	PARA CONE 20 PD, E27 _____	313	PURI 2.0 CONE CW, TRIPLE LONG, QPAR51 _____	423
ONE® 60 PD, DALI, UP/DOWN _____	271	PARA CONE 30 PD, E27 _____	313	PURI 2.0 CONE CW, TRIPLE ROUND, QPAR51 _____	423
ONE® 60 PD, PHASE, UP/DOWN _____	271	PARA CONE GL MONOF., GU10 _____	587	PURI 2.0 CONE CW, TRIPLE ROUND, QPAR51 _____	423
ONE® 80 PD, DALI _____	273	PARA CONE GL TRIF., GU10 _____	653	PURI 2.0 CONE PD, MONOF., QPAR51 _____	565
ONE® 80 PD, DALI, UP/DOWN _____	273	PARA CONE GL PD, GU10 _____	653	PURI 2.0 CONE PD, TRIF., QPAR51 _____	621
ONE® CUBE PD, DALI _____	269	PARA DOME PD, E27 _____	320	PURI 2.0 CONE ABAJUR _____	567, 623
ONE® CUBE PD, DALI, UP/DOWN _____	269	PARA DOME ABAJUR _____	320	PURI 2.0 DOME _____	424
ONE® DOUBLE PD, DALI, UP/DOWN _____	274	PATTA-F EL, CUADRADO, PHASE _____	165	PURI 2.0 DOME MONOF., QPAR51 _____	563
ONE® DOUBLE PD, PHASE, UP/DOWN _____	274	PATTA-F EL, REDONDO, PHASE _____	164	PURI 2.0 DOME TRIF., QPAR51 _____	619
ONE® PLACA DE FELTRO, FELTRO ACÚSTICO, P/ ONE® 80/ ONE® CUBE _____	269, 273	PATTA-I DL, CUADRADO, PHASE _____	162	PURI 2.0 DOME CW, DOUBLE ASYM., QPAR51 _____	424
ONE® FLAT PD, DALI, TRIPLE _____	265	PATTA-I EL, CUADRADO, PHASE _____	163	PURI 2.0 DOME CW, DOUBLE LONG, QPAR51 _____	425
ONE® FLAT PD, PHASE, SINGLE _____	265	PATTA-I EL, REDONDO, PHASE _____	162, 163	PURI 2.0 DOME CW, QUADRUPLE LONG, QPAR51 _____	425
ONE® LINEAR 100 PD, PHASE, UP/DOWN _____	277	PEMA® WL _____	896, 897	PURI 2.0 DOME CW, INTERRUPTOR, SINGLE, QPAR51 _____	425
ONE® LINEAR 140 PD, PHASE, UP/DOWN _____	277	PEMA® WL, E27 _____	897	PURI 2.0 DOME CW, SINGLE, QPAR51 _____	425
ONE® TRIPLE PD, DALI _____	275	PHELIA 10 PD, E27 _____	315		
ONE® VERTICAL PD, PHASE _____	267	PHELIA 20 PD, E27 _____	315		
ORDI II POLE 45 _____	795	PHELIA 30 PD, E27 _____	315		
ORDI II POLE 70 _____	795	PHELIA FL, E27 _____	499		
ORDI II POLE 70, SENSOR _____	795	PHELIA WL, QPAR51 _____	416		
ORDI II SENSOR WL _____	916	PHOTONI 45 POLE, E27 _____	713		
ORDI II WL _____	916	PHOTONI 75 POLE, E27 _____	713		
ORDI SENSOR WL _____	917	PHOTONI CL, E27 _____	825		
ORDI WL _____	917	PHOTONI CYL CL _____	825		
OSSA 180 WL, QT-DE12 _____	397	PHOTONI CYL POLE 45 _____	711		
OSSA 300 WL, QT-DE12 _____	397	PHOTONI CYL POLE 75 _____	711		
OTOS GLAS POLE, E27 _____	771	PHOTONI CYL WL _____	844		

PURI 2.0 DOME CW, TRIPLE LONG, QPAR51	425
PURI 2.0 DOME CW, TRIPLE ROUND, QPAR51	425
PURI 2.0 DOME PD, MONOF., QPAR51	565
PURI 2.0 DOME PD, TRIF., QPAR51	621
PURI 2.0 DOME ABAJUR	567, 623
PURI 2.0 TUBE	420
PURI 2.0 TUBE MONOF., QPAR51	563
PURI 2.0 TUBE TRIF., QPAR51	619
PURI 2.0 TUBE CW, DOUBLE ASYM., QPAR51	420
PURI 2.0 TUBE CW, DOUBLE LONG, QPAR51	421
PURI 2.0 TUBE CW, QUADRUPLE LONG, QPAR51	421
PURI 2.0 TUBE CW, INTERRUPTOR, SINGLE, QPAR51	421
PURI 2.0 TUBE CW, SINGLE, QPAR51	421
PURI 2.0 TUBE CW, TRIPLE LONG, QPAR51	421
PURI 2.0 TUBE CW, TRIPLE ROUND, QPAR51	421
PURI 2.0 TUBE PD, MONOF., QPAR51	565
PURI 2.0 TUBE PD, TRIF., QPAR51	621
PURI 2.0 TUBE ABAJUR	567, 623
PURI CONE ABAJUR	429
PURI CW	431
PURI CW, DOUBLE, QPAR51	431
PURI CW, QUAD, QPAR51	431
PURI CW, SINGLE, QPAR51	431
PURI CW, TRIPLE, QPAR51	431
PURI DOME ABAJUR	429
PURI TRACK MONOF., QPAR51	591
PURI TRACK MONOF., TRIPLE TRACK SET	591
PURI TRACK TRIF., QPAR51	661
PURI TUBE ABAJUR	429
PURIA TRACK MONOF., QPAR51	593

**Q**

Q-LINE® CL, 1M, BAP, PHASE	215
Q-LINE® CL, 2M, BAP, PHASE	215
Q-LINE® PD, 1M, BAP, PHASE	295
Q-LINE® PD, 2M, BAP, PHASE	295
Q-LINE® PD, DALI, SINGLE	295
Q-LINE® WL	368
Q-RING WL	849
Q-RING WL, SENSOR	849
QUAD FRAME 14 WL	395
QUAD FRAME 19 WL	395
QUAD POLE POLE	800
QUAD UP/DOWN 15 WL	893
QUAD WL	892
QUADRASS PD, E27	311
QUADRASS SPOT WL, E27	403
QUADRASS WL, E27	403
QUADRASYL 75 POLE, TCR-TSE	799
QUADRASYL WL, TCR-TSE	927
QUADRULO CL	941
QUADRULO FL	749
QUADRULO SENSOR WL, E27	883
QUADRULO WL	882
QUADRULO WL, E27	883
QUIMERA MONOF., PD	559
QUIMERA PD, PHASE	223
QUIMERA TL	481
QUIMERA WL, PHASE	329

**R**

R-CUBE 35 POLE	715
R-CUBE 75 POLE	715
R-CUBE CW	935
R-CUBE W	843
RASTERLYS POLE 70	735
RASTERLYS WL	933

ROCCI 200 EL, QUADRADO	985
ROCCI 200 EL, REDONDO	985
ROCCI EL, QUADRADO	984
ROCCI EL, REDONDO	984
ROTOBALL 25 FL, E27	769
ROTOBALL 25 PD, E27	319
ROTOBALL 40 FL, E27	769
ROTOBALL 40 PD, E27	319
ROTOBALL 50 FL, E27	769
ROTOBALL 50 PD, E27	319
ROX ACRYL 30 POLE, E27	781
ROX ACRYL 60 POLE, E27	781
ROX ACRYL 90 POLE, E27	781
ROX CL, GX53	837
ROX CL, QPAR111	837
ROX UP/DOWN WL, QPAR111	907
RUBA CW	944
RUSTY® 40 POLE	754
RUSTY® 40 POLE, E27	755, 758
RUSTY® 70 POLE	755
RUSTY® 70 POLE, E27	755, 758
RUSTY® CONE 24 FL, E14	757
RUSTY® CONE 40 POLE, E27	757
RUSTY® CONE 70 POLE, E27	757
RUSTY® MANA ABAJUR, QUADRADO	858
RUSTY® MANA ABAJUR, REDONDO	858
RUSTY® PATHLIGHT 40 POLE	753
RUSTY® PATHLIGHT 70 POLE	753
RUSTY® PATHLIGHT POLE, TCR-TSE	752
RUSTY® SLOT 50 POLE	750
RUSTY® SLOT 50 POLE, E27	751
RUSTY® SLOT 80 POLE	750
RUSTY® SLOT 80 POLE, E27	751
RUSTY® UP/DOWN WL, QUADRADO	894
RUSTY® UP/DOWN WL, REDONDO	894

**S**

S-CUBE 35 POLE	714
S-CUBE 75 POLE	714
S-CUBE CL	826
S-CUBE CW	843, 935
S-TUBE 32 POLE, GU10	709
S-TUBE 75 POLE, GU10	709
S-TUBE CW	935
SALUNA LV, QR-C51	547
SAMRINA SP, SINGLE, GU10	809
SEDO 14 WL	360
SEDO 21 WL	360
SENER 12 CW, QUADRADO, PHASE	459
SENER 12 CW, REDONDO, PHASE	461
SENER 12 EL, QUADRADO	143
SENER 12 EL, REDONDO	141
SENER 18 CW, QUADRADO, PHASE	459
SENER 18 CW, REDONDO, PHASE	461
SENER 18 EL, QUADRADO	143
SENER 18 EL, REDONDO	141
SENER 24 CW, QUADRADO, PHASE	459
SENER 24 CW, REDONDO, PHASE	461
SENER 24 EL, QUADRADO	143
SENER 24 EL, REDONDO	141
SIGHT 115 CW	369, 475
SIGHT 60 CW	369, 475
SIGHT EASY TRIF.	647
SIGHT EASY TRIF. DALI	647
SIGHT MOVE TRIF.	649
SIGHT MOVE TRIF., DALI	649
SIGHT TRACK TRIF.	648
SIGHT TRACK TRIF., DALI	648
SIMA CW, QUADRADO, PHASE	463
SIMA CW, QUADRADO, SENSOR	463
SIMA CW, REDONDO, PHASE	462
SIMA CW, REDONDO, SENSOR	462
SITRA 360 CW, TCR-TSE	938
SITRA 360 POLE, TCR-TSE	801

SITRA 360 SPIKE SP, DOUBLE, TCR-TSE	821
SITRA 360 SPIKE SP, SINGLE, TCR-TSE	821
SITRA CL, TCR-TSE	835
SITRA CUBE WL, TCR-TSE, UP/DOWN	879
SITRA L WL, UP/DOWN, QUADRADO	879
SITRA M WL, UP/DOWN, QUADRADO	879
SITRA S WL, SINGLE, QUADRADO	877
SITRA UP/DOWN WL	905
SITRA UP/DOWN WL, TCR-TSE	905
SITRA WL, TCR-TSE	925
SLOTBOX 40 POLE	791
SLOTBOX 70 POLE	791
SLOTS 45 POLE	787
SLOTS 65 POLE	787
SMALL PLOT COBERTURA, 2 PEÇAS	981
SMALL PLOT COBERTURA, 4 PEÇAS	981
SMALL PLOT MÓDULOS	981
SOLASTO EL, QUADRADO	987
SOLASTO EL, REDONDO	987
SOLID CUBE WL, QT14	405
SOMNILA FLEX WL, ESQUERDA	413
SOMNILA FLEX WL, DIREITA	413
SOMNILA SPOT WL, ESQUERDA	412
SOMNILA SPOT WL, DIREITA	413
SOPRANA CL, E27	209
SPOT 79 CW, QPAR51	457
SQUARE POLE 30 POLE, E27	785
SQUARE POLE 60 POLE, E27	785
SQUARE POLE 90 POLE, E27	785
SQUARE TURN WL, G9	927
SQUARE WL, E27	925
SUN 20 CL, E27	168
SUN 20 PD, E27	228
SUN 30 CL, E27	169
SUN 30 PD, E27	229
SUN GRID	701
SUN WL, G9 QUADRADO	334
SUN WL, G9 ARREDONDADO	335
SURFACE V 390	1001
SURFACE V 390 SENSOR	1001
SYNA GARDEN SP	807
SYNA PLANT SP	807
SYNA SHADE, SP, GU10	805
SYNA SP	807
SYNA WIDE, SP	804
SYROS LV, QR-C51	547

**T**

T-TUBE 70 POLE, GU10 DOUBLE	741
T-TUBE 70 POLE, GU10 DOUBLE, SENSOR	740
T-TUBE 70 POLE, GU10 SINGLE	741
T-TUBE 70 POLE, GU10 SINGLE, SENSOR	740
T-TUBE WL GU10 DOUBLE	909
T-TUBE WL GU10 DOUBLE, SENSOR	908
T-TUBE WL GU10 SINGLE	909
T-TUBE WL GU10 SINGLE, SENSOR	908
TAHA CONJUNTO DE LUMINÁRIAS, BATERIA	488, 707
TELESKOP LV, QR-C51	544
TENSEO CABO DE BAIXA TENSÃO	540, 541
TENSEO ACESSÓRIOS DE CABO DE BAIXA TENSÃO	543
TENORA CL, E27	208
TERANG 200 CW	944
THEO BRACKET CW	938
THEO BRACKET SP	819
THEO PATHLIGHT POLE, DOUBLE	764
THEO UP/DOWN WL, QPAR51	405, 861
THEO WL, QPAR51	862
TINY SUN TL	491
TODAY PRO DISPLAY	929
TONGA® MONOF., PD, E14	592
TONGA® PD, E14	311
TRACKSPOT V TRIF.	1002, 1003



TRAIL-LITE® 60 EL _____	978	WORKLIGHT PRO FL, DOUBLE _____	492
TRILEDO CL, DOUBLE, QUADRADO _____	181	WORKLIGHT PRO FL, SINGLE _____	492
TRILEDO CL, DOUBLE, QUADRADO, QPAR51 _____	193	WORKLIGHT TL _____	493
TRILEDO CL, SINGLE, QUADRADO _____	181	WORO EL _____	161
TRILEDO CL, SINGLE, QUADRADO, QPAR51 _____	193	WUD PD, E27, BALLSHAPE _____	226
TRILEDO CL, SINGLE, REDONDO _____	181	WUD PD, E27, CLYLINDRICAL _____	227
TRILEDO CL, SINGLE, REDONDO, QPAR51 _____	193	WUD PD, E27, CONICAL _____	227
TRUKKO 60 WL _____	359	WUD PD, E27, HALF ROUND _____	227
TRUKKO 80 WL, REDONDO _____	359		
TRUKKO 90 WL _____	359		
TRUKKO WL, REDONDO _____	358		
TRUKKO WL, RETANGULAR _____	358		
TRUST 30 POLE _____	779		
TRUST 60 POLE _____	779		

**U**

UNIVERSAL DOWNLIGHT COVER, NON TILT, QUADRADO _____	59, 1011
UNIVERSAL DOWNLIGHT COVER, NON TILT, REDONDO _____	59, 1011
UNIVERSAL DOWNLIGHT COVER, TILT, QUADRADO _____	59, 1011
UNIVERSAL DOWNLIGHT COVER, TILT, REDONDO _____	59, 1011
UNIVERSAL DOWNLIGHT DL, PHASE _____	059
UNIVERSAL DOWNLIGHT DL, PHASE, LOTE _____	1011

**V**

VANO WING SP, DALI _____	857
VAP SLIM 30 POLE, E27 _____	783
VAP SLIM 60 POLE, E27 _____	783
VAP SLIM 90 POLE, E27 _____	783
VARU EL, QPAR51 _____	152
VARYT _____	333
VARYT CL, E14 _____	177
VARYT DIFUSOR EM VIDRO DIAMANTE P/ PD, WL, CL, TL _____	177, 225, 333, 479
VARYT DIFUSOR EM VIDRO P/ PD, WL, CL, TL _____	177, 225, 333, 479
VARYT DIFUSOR EM VIDRO LINHA P/ PD, WL, CL, TL _____	177, 225, 333, 479
VARYT DIFUSOR EM VIDRO PLISSADO P/ PD, WL, CL, TL _____	177, 225, 333, 479
VARYT PD, E14 _____	225
VARYT TL, E14 _____	478
VERLUX EL, QUADRADO, PHASE _____	145
VILUA L WL _____	903
VILUA S WL _____	903
VILUA UP/DOWN, WL _____	903
VINOLINA ONE TL, ACUMULADOR _____	485, 703
VINOLINA TL, ACUMULADOR _____	485, 703
VINOLINA TWO CABO DE LIGAÇÃO PARA APARELHO DE FRIO COM FICHA DE SEGURANÇA _____	487, 705
VINOLINA TWO BASE DE CARREGAMENTO _____	487, 705
VINOLINA TWO TL, ACUMULADOR, DTW _____	487, 705

**W**

WALLYX WL, QPAR51 _____	910
WATERPROOF V 600 _____	1013
WATERPROOF V 1200 _____	1014
WATERPROOF V 1500 _____	1017
WATERPROOF V DALI 600 _____	1013
WATERPROOF V DALI 1200 _____	1015
WATERPROOF V DALI 1500 _____	1017
WL 106 E14 _____	364
WORKLIGHT FL _____	493
WORKLIGHT PD, DALI _____	290
WORKLIGHT PRO 120 PD, DALI _____	289
WORKLIGHT PRO 150 PD, DALI _____	289

# EXPLICAÇÃO DOS SÍMBOLOS



## Recomendações

Indica recomendações de acessórios e lâmpadas para os respetivos produtos

## MIX match

## Mix & Match

Identifica produtos que podem ser combinados individualmente



## Classe de eficiência energética

„Esta luminária é adequada para lâmpadas das classes energéticas ...“



Regulável com:

- **C** = Dimmer de corte de fase inversa
- **L** = Dimmer de corte de fase ascendente
- **Uni** = Dimmer universal
- **1-10 V**
- **Dali** = Sistema de bus DALI
- **Switch** = Interruptor/botão ou Touch Control na luminária
- **Touch** = Funcionamento simples e contínuo; responde ao toque



Classes de proteção

- Índice de proteção I/conductor de proteção
- Índice de proteção II/proteção por isolamento duplo ou reforçado
- Classe de proteção III/proteção por tensão reduzida



## Índice de proteção IP:

Determina a compatibilidade do equipamento elétrico para várias condições meteorológicas.



## Grau de resistência ao impacto IK:

O grau de resistência ao impacto IK é uma medida de resistência dos compartimentos de equipamentos elétricos à carga mecânica exercida, em particular, aos impactos.



Ângulo de meia dispersão:

Descreve o ângulo de difusão em graus. Quanto menor for o ângulo, maior é a concentração de luz.

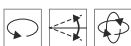

Capacidade de rotação e oscilação em graus:

- Alcance giratório
- Alcance da articulação Cardan



## Unified Glare Rating:

Quanto menor for o valor UGR, menor é o encandeamiento.



Manutenção do fluxo luminoso:

Descreve quanto o fluxo luminoso de um LED diminui no período especificado.



Comprimento do cabo suspenso em cm



Comprimento do cabo de alimentação em cm  
Comprimento do cabo de alimentação em cm (cabo com extremidade aberta)



Formato da abertura de instalação



Especificação da profundidade de instalação



Capacidade de resistência à compressão do produto indicado



Capacidade de peso do produto até ao valor indicado em toneladas. As medições baseiam-se numa pavimentação em betão.



Permite a instalação de equipamento elétrico em materiais cujas características de inflamabilidade não são conhecidas.



Possibilidade de passagem de cabos



Conversor independente: Dispositivo de controlo também para utilização fora das luminárias



Dispositivo de controlo de segurança à prova de curto circuito



Utilização exclusivamente para espaços interiores. Inadequado para utilização em espaços exteriores



Revestimento resistente à brisa do mar



Connected Lighting:

Identifica os produtos inteligentes que utilizam os seguintes protocolos:

- Zigbee®
- DALI
- Bluetooth



Interruptor **CCT**:

Durante a instalação e através do interruptor CCT integrado, poderá seleccionar a temperatura de cor da luz entre 2700K, 3000K, 4000K ou 6500K.



Identifica luminárias com RGB+W e RGB (encarnado-verde-azul + branco e encarnado-verde-azul)



Dim-to-Warm:

Ao regular, a cor da luz muda de branco neutro/frio para branco quente.



- Produtos com LEDs integrados
- Produtos com casquilho de lâmpada

Uma grande parte dos produtos apresentados neste catálogo está protegida por marcas registradas, projetos, modelos de utilidade ou patentes. Uma violação destes direitos de propriedade ou o uso de design de texto e layout, bem como imagens protegidas por direitos de autor sem a nossa aprovação, será processado legalmente. As ilustrações e informações contidas neste catálogo são apenas para fins ilustrativos e não são vinculativas no que diz respeito a cor, formato, design e dados técnicos. Reserva-se, portanto, o direito a alterações e erros em todas as descrições/informações do produto.

Todos os produtos da nossa gama estão sujeitos a uma rigorosa garantia de qualidade e satisfazem as normas geralmente aplicáveis. Este catálogo contém uma gama geral e não é específico do país. Quaisquer desvios dos requisitos específicos do país devem ser esclarecidos antes da encomenda. A SLV não se responsabiliza por eventuais normas técnicas divergentes. Todas as indicações de peso e comprimento são fornecidas em kg ou cm, salvo indicação em contrário. Sujeito a alterações técnicas!

A apresentação das nossas luzes com fotos realistas e exemplares da aplicação é possibilitada pela cortesia amigável e pelo consentimento dos proprietários ou projetistas dos ambientes que podem ser vistos principalmente nas imagens. Gostaríamos de aproveitar esta oportunidade para agradecer a todos os que contribuíram para a produção e utilização das nossas fotos!

Com a publicação deste catálogo, os preços nas listas e catálogos publicados anteriormente são inválidos. A SLV tem o direito de adaptar a respetiva lista de preços às alterações nas condições de mercado, no caso de alterações significativas nos custos de aquisição, no imposto de valor acrescentado ou nos preços de aquisição.

Todos os preços são preços recomendados de venda ao público em euros sem IVA incluído.

Editor  
SLV GmbH, Alemanha  
Daimlerstraße 21-23  
52531 Übach-Palenberg  
T +49 (0) 2451 4833-0  
slv.com

Copyright  
© SLV GmbH, 2024





A SLV está entre os 5% das principais empresas avaliadas pela EcoVadis no início de 2024, demonstrando o seu forte sistema de gestão de sustentabilidade.

SLV GmbH | Daimlerstraße 21-23, 52531 Uebach-Palenberg, Germany, +49 (0) 2451 4833 - 333, info@slv.de  
SLV Austria | +49 (2451) 4833 355, export@slv.de  
SLV Belgium | Herentalsebaan 429, B-2160 Wommelgem, +32 (0) 3/385 30 08, info@slv.be  
SLV Nordics | Flade Engvej 4, 9900 Frederikshavn, Denmark, +45 9310 7474, info@nordics.slv.com  
SLV France | Zac du Martelet, 88, rue Henri Dépaigneux, F-69400 Limas, +33 4 74 02 71 20, infofr@slv.com  
SLV LIGHTING UK LTD | Unit E Chiltern Park, Boscombe Road, Dunstable, LU5 5LT, +44 (0)203 968 11 00, sales@uk.slv.com  
SLV Italia S.r.l. | Via Lecco, 19/D, 23896 Bevera di Sirtori (LC), +39 039 5983575, infoit@slv.com  
SLV Nederland | Kazernestraat 19, 5928 NL Venlo, +31 773204343, info@slv.nl  
SLV i Norge, del av SLV Nordics | Tors veg 9B, 7035 Trondheim, +47 4777 1080, post-no@slv.com  
SLV Poland | al. Jerozolimskie 200, 02-486 Warszawa, Polska, (0048 22) 722-49-75, slv@slv.pl  
SLV Portugal | R. Margarida de Abreu, no13 – Lj2, 1900-314 Lisboa, +351 210 185 961, info@pt.slv.com  
SLV Swiss SA | Route du Bey 6 Box 1-4, Z.I. La Jonnaire, CH-1847 Rennaz, +41 218113232, info@slv-swiss.ch  
SLV d.o.o | Barjanska cesta 50, SI-1000 Ljubljana, +386 1 2009 730, info@slv.si  
SLV Spain | Antic Cami Ral Valencia, 38, L17, 08860 Castelldefels, Barcelona, 931 168 161, info@slv.es  
SLV Czech s.r.o. | V Sedlci 28/17, CZ-160 00 Praha 6, +420 739 282 151, info@cz.slv.com



slv.com